

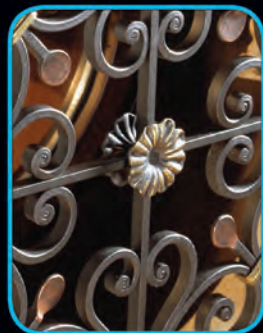

**STEEL
MART, INC.**

CATALOG 3
2023/2024



**HARDWARE
AND
SUPPLIES**



**STEEL
MART, INC.**

SteelMart stocks a full line of hardware, ornamental metal and paint, in addition to warehousing an extensive selection of steel.



We Guarantee

- Competitive Pricing
- Quick Turnaround
- Friendly Service

Visit Our Online Catalog

www.steelmartatlanta.com

WE'RE EXPANDING!

SteelMart Athens

200 Dairy Park Road
Athens, GA 30607

Please Call Our Tucker
Location for More
Information

Tucker

2018 Steel Drive
Tucker, GA 30084

Toll Free Number: (888) 416-6999

Phone Number: (770) 416-6999

Fax Number: (770) 416-9041

Hours of Operation

M-F 7:30 AM-4:30 PM

Gainesville

455 Industrial Boulevard
Gainesville, GA 30501

Toll Free Number: (888) 297-6675

Phone Number: (770) 297-6675

Fax Number: (770) 297-6676

Hours of Operation

M-F 8:00 AM-4:30 PM

TUCKER

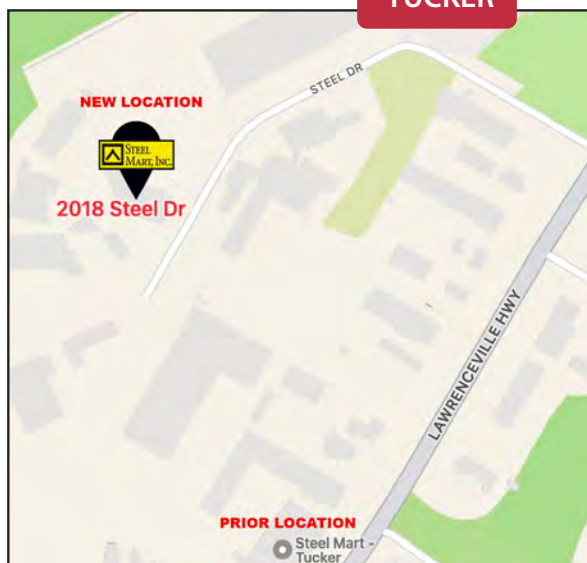

GAINESVILLE

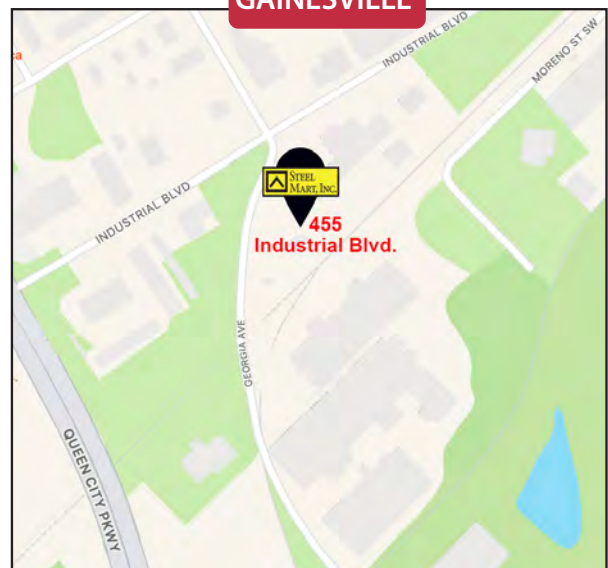

CONTENTS

CATALOG 3

Section	Page
▶ Fence Panels, Gates & Installation Hardware	2 - 19
▶ Gate & Door Hardware	20 - 90
▶ Ornamental Metal & Stainless Steel Railing	91 - 183
▶ Aluminum Forgings & Castings	184 - 187
▶ Cast Iron	188 - 207
▶ Welding Machines	208
▶ Shop Supplies	
▶ Welding Supplies	209 - 239
▶ Paint & Abrasives	
▶ Gate Operators	
▶ Access Control Products	240 - 250

Now Stocking
Weld Studs

PAGE 74
Choose from
5 SIZES



Find a Selection of Balusters
Beginning on Page 145



Find the Latest **Kwikset**
Styles and Finishes

PAGES 46 - 47



NEW!

CONTEMPORARY WOVEN WIRE MESH PANELS
4 FT X 8 FT CARBON STEEL PANELS

MADISON BOND ABBEY STRAND

NEW FENCING LINE

PAGE 5

GALVANIZED AGRICULTURE PANELS

Multi-Use Panel - 8 FT

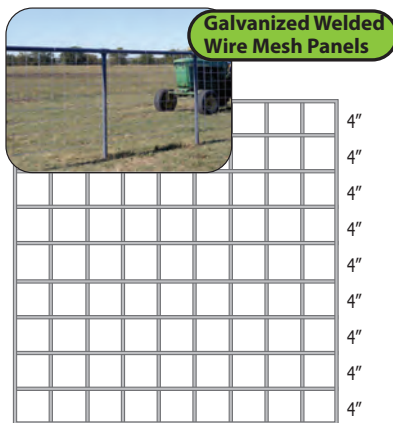

EASIER TO HAUL!
8 FT Panels Fit Easily
In Your Pickup Bed

4" x 4" Wire Spacing
» 6 gauge wire

ITEM #	DESCRIPTION
FRF48	4 FT x 8 FT Stock Panel
FRF58	5 FT. x 8 FT Stock Panel

Cattle Panel - 16 FT

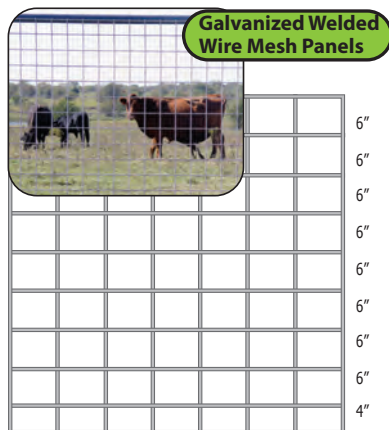

This Panel is for Store Pick-up Only

8" x 6"/4" Wire Spacing
» 4 gauge wire

ITEM#	DESCRIPTION
FRF5216	50 IN. x 16 FT Cattle Panel

Hog Panel - 16 FT

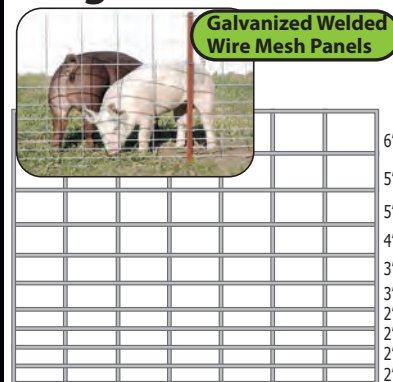

This Panel is for Store Pick-up Only

Variable Wire Spacing
» 4 gauge wire

ITEM#	DESCRIPTION
FRF3416	34 IN. x 16 FT Hog Panel

Perforated Metal Screening

22 Ga. Cold Rolled Steel Stocked in
3 ft. x 7 ft. Sheets

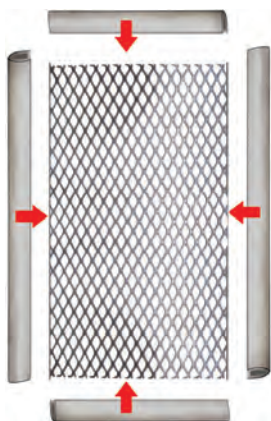

Trim Out Perforated Metal
Screening with U-Edging
Listed On Page 90

1/16" HOLES



3/32" HOLES



ITEM #	HOLE SIZE	CENT	SHEET SIZE
PMPS22116	1/16"	1/8"	3' x 7'
PMPS22332	3/32"	5/32"	3' x 7'

HORSE PANELS



WELDED WIRE

NO CLIMB

PANELS!



**HIGH-QUALITY
CONSTRUCTION IN AN
EASY-TO-INSTALL
PANEL**

Designed to Keep Horses Safe

- Designed with 2"x 4" Spacing to Prevent Horse from Climbing or Getting Hoof Caught
- Tight Spacing Keeps Predators Out
- Mesh Flexes Upon Impact, Preventing Injuries

Easy Install / Transportation

- Lightweight, Frame-less Panels are Easily Loaded and Transported
- Panels Enable a Quick, Efficient Install
- Smoothly Adapts to the Terrain

*A Popular Choice for:
Enhancing Fence Design
Dog Kennels
Pasture Fencing
Gate Construction*

These Panels are Great for Constructing Gates

Built to Last

- Durable, Welded Wire Construction
- Galvanized to Withstand Extreme Weather
- 6ga Steel

PANELS Available in 4 Sizes

ITEM #	GA.	SPACING	HEIGHT	LENGTH
WM4264820	6ga	2" x 4"	4 ft	20 ft
WM4266020	6ga	2" x 4"	5 ft	20 ft
WM4267220	6ga	2" x 4"	6 ft	20 ft
WM4266016	6ga	2" x 4"	5 ft	16 ft

**The Durable and
Affordable Choice**

Also Available in Rolls

Ask Your Sales Rep for More Information

**Choose the Best Option
for Your Job...**

**NO CLIMB FENCE ALSO
STOCKED IN ROLLS**

*Spacing on the Panels Match the
Spacing on the Rolls*



GALVANIZED WELDED WIRE MESH PANELS

STOCKING 4 SIZES

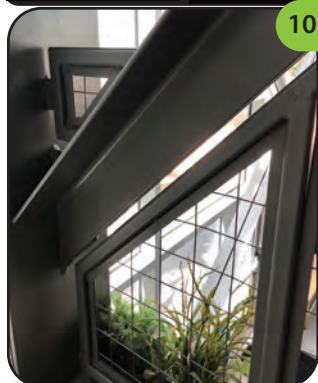
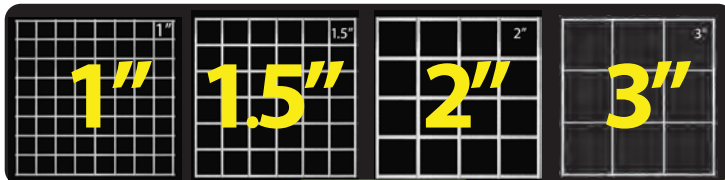

10 Gauge Wire

TRIM PANELS WITH U-EDGING

PAGE 90

AVAILABLE IN FIVE SIZES

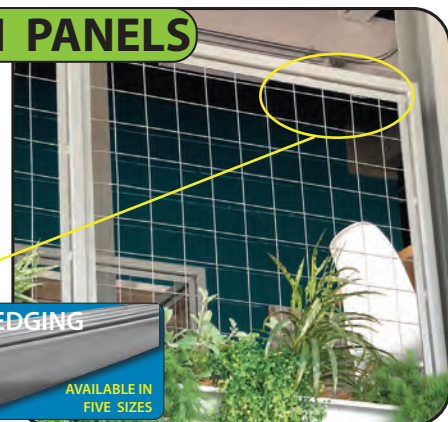

- » Galvanize protection for long life
- » Weld or install with screws then paint to match fence
- » Use as added security for gates to stop reaching through bars to open gate
- » Many agricultural, interior, exterior & security applications

SHIPPING of WIRE MESH PANELS

- All Panels Available for Shipping - ANY QUANTITY NO MINIMUM
- A Skid and Packing Charge Will Be Added to All Wire Mesh Panel Shipments
- Skid/Packing Charge Does Not Apply to In Store Pickups

Add to Your Existing Gate for Additional Security



ITEM #	DESCRIPTION	PANEL SIZE
FRZ1G	1" x 1" Galvanized Wire Mesh Sheet	44-1/4" X 114"
FRZ112G	1-1/2" x 1-1/2" Galvanized Wire Mesh Sheet	43-3/4" X 116"
FRZ2G	2" x 2" Galvanized Wire Mesh Sheet	44-1/4" X 114"
FRZ3G	3" x 3" Galvanized Wire Mesh Sheet	42" X 114"

NON-GALVANIZED WELDED WIRE MESH PANELS

Non-Galvanized Panels will Naturally Take on the Popular Rust Finish when Exposed to the Elements

Rusted Panels

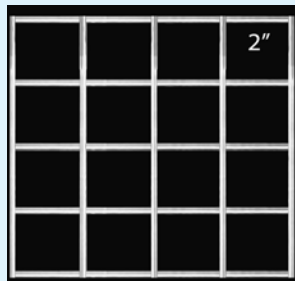

Raw Steel

Heavy-Duty Panels



ITEM #	DESCRIPTION	SIZE	PANEL SIZE
WM218848120	2" x 2" NON-Galvanized Wire Mesh	3/16"	48" X 120"
WM225048120	2" x 2" NON-Galvanized Wire Mesh	1/4"	48" X 120"
WM319248120	3" x 3" NON-Galvanized Wire Mesh	3/16"	48" X 120"



CONTEMPORARY WOVEN WIRE MESH PANELS

4 FT X 8 FT CARBON STEEL PANELS

BOND

The Bond is a Single Crimped Woven Wire Mesh Panel

OPENING: 7/8" X 7/8" Approx.

WIRE DIAMETER: .120"

EDGES: Not Framed

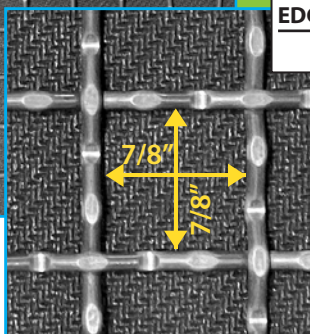

ITEM #	PANEL
WMB1WC1	48" X 96"

ABBEY

The Bond is a Double Crimped Woven Wire Mesh Panel

OPENING: 7/8" X 7/8" Approx.

WIRE DIAMETER: .120"

EDGES: Not Framed

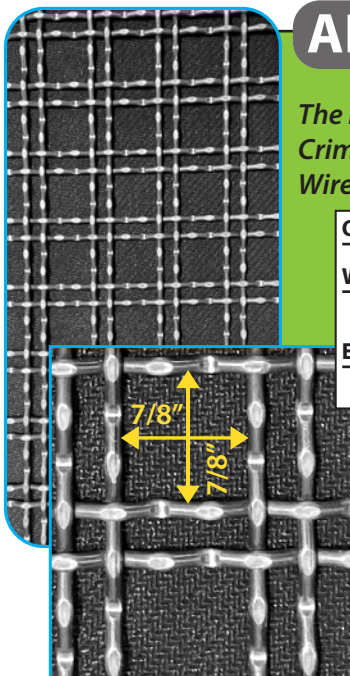

ITEM #	PANEL
WMA2WC1	48" X 96"

MADISON

The Madison is a Double Woven Wire Mesh Panel

OPENING: 1-1/4" X 1-1/4" Approx.

WIRE DIAMETER: .120"

EDGES: Not Framed

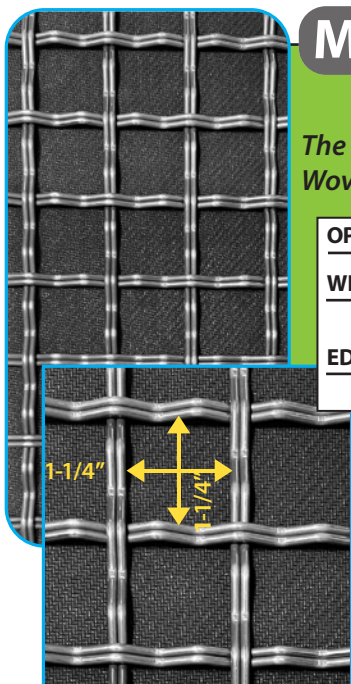

ITEM #	PANEL
WMM2W112	48" X 96"

STRAND

The Strand is a Woven Strip Wire Mesh Panel

OPENING: 3/8" X 3/8" Approx.

WIRE: 16ga X 1/8" Width

EDGES: Not Framed

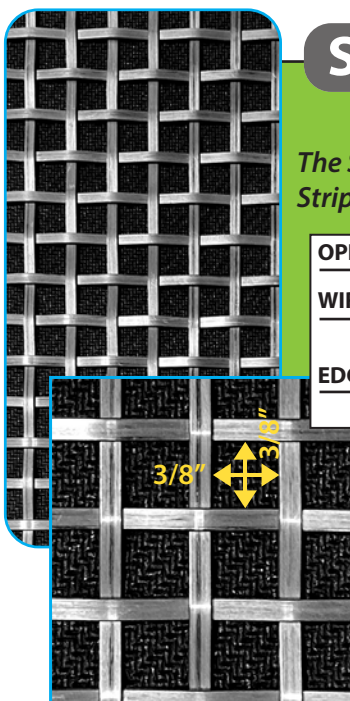

ITEM #	PANEL
WMS800	48" X 96"



LEED

All Designmaster Fence Products Qualify for LEED Credits Needed to Achieve LEED Certification



GREEN



BLACK



BROWN



WHITE



BLUE



YELLOW



RED



GRAY



GALVANIZED

Classic Fence Panel



Contempo Fence Panel



Classic Fence Panel

ITEM#	DIMENSIONS	COLOR
FW12052	24"H X 96"W	Black
FW12008	48"H X 96"W	Black
FW12000	48"H X 96"W	Green
FW12744	48"H X 96"W	Gray
FW12818	48"H X 96"W	Galvanized
FW12009	60"H X 96"W	Black
FW63868	60"H X 96"W	Gray
FW12805	60"H X 96"W	Galvanized
FW12010	72"H X 96"W	Black
FW12002	72"H X 96"W	Green
FW12212	72"H X 96"W	Gray
FW12061	72"H X 96"W	Galvanized
FW12011	96"H X 96"W	Black
FW12819	96"H X 96"W	Galvanized

CLASSIC & CONTEMPO

NOTE

Not All Items Stocked at All Locations.

Some Items May be Shipped to Store for Pickup

IN STOCK

BLACK | GRAY | GALVANIZED
GREEN*

SPECIAL ORDER

BROWN | WHITE | BLUE
YELLOW | RED

(*Limited Green in stock. May require special order.)

Contempo Fence Panel

ITEM#	DIMENSIONS	COLOR
FW64874	48"H X 98.4"W	Black
FW64882	48"H X 98.4"W	Gray
FW64883	48"H X 98.4"W	Galvanized
FW61538	72"H X 98.4"W	Black
FW63756	72"H X 98.4"W	Gray
FW61994	72"H X 98.4"W	Galvanized
FW61535	96"H X 98.4"W	Black
FW63763	96"H X 98.4"W	Gray
FW62991	96"H X 98.4"W	Galvanized

Posts and Accessories on This Page Can Be Used with Both Classic and Contempo Fence Panels

Brackets are required for each post as follows:

Posts for 2' Panel = 2
 Posts for 4' Panel = 2
 Posts for 5' Panel = 3

Posts for 6' Panel = 4
 Posts for 8' Panel = 5



All Designmaster Fence Products Qualify for LEED Credits Needed to Achieve LEED Certification



2-1/4" x 2-1/4" Post



Post

ITEM#	HEIGHT	GAUGE	COLOR
FW12020	72"	16	Black
FW12022	96"	16	Black
FW12023	132"	16	Black
FW12743	72"	16	Gray
FW12213	96"	16	Gray
FW12216	132"	16	Gray
FW12012	72"	16	Green
FW12014	96"	16	Green

Brackets

use with 2-1/4" x 2-1/4" Posts



Each box of brackets contains:
 25 Brackets, 25 Bolts, 25 Nuts

ITEM#	COLOR
FW12514	Black
FW12518	Gray
FW12515	Green
FW21803	Galvanized

3" x 3" Post



Post

ITEM#	HEIGHT	GAUGE	COLOR
FW63946	72"	11	Black
FW12987	84"	11	Black
FW12896	96"	11	Black
FW12817	132"	11	Black
FW25358	168"	11	Black
FW63954	72"	11	Gray
FW12992	96"	11	Gray
FW12993	132"	11	Gray
FW12855	96"	11	Green
FW12856	120"	11	Green

Brackets

use with 3"x3" Posts



Each box of brackets contains:
 25 Brackets, 25 Bolts, 25 Nuts

ITEM#	COLOR
FW12410	Black
FW12937	Gray
FW12412	Green
FW12816	Galvanized

4" x 4" Post



Post

ITEM#	HEIGHT	GAUGE	COLOR
GP41110	120"	11	Black

Single Clamp

- » Use with 4" x 4" Posts
- » 25/box, includes hardware



ITEM#	COLOR
FW78766	Black
FW78770	Gray
FW78768	Green
FW10558	Galvanized

Brackets

use with 2" x 2" Posts



Each box of brackets contains:
 25 Brackets
 25 Bolts
 25 Nuts

ITEM#	COLOR
FW12873	Black
FW12879	Gray
FW12876	Green
FW12882	Galvanized



LEED

All Designmaster Fence Products Qualify for LEED Credits Needed to Achieve LEED Certification



GREEN



BLACK



BROWN



WHITE



BLUE



YELLOW



RED



GRAY



GALVANIZED

Forte Fence Panel & Accessories

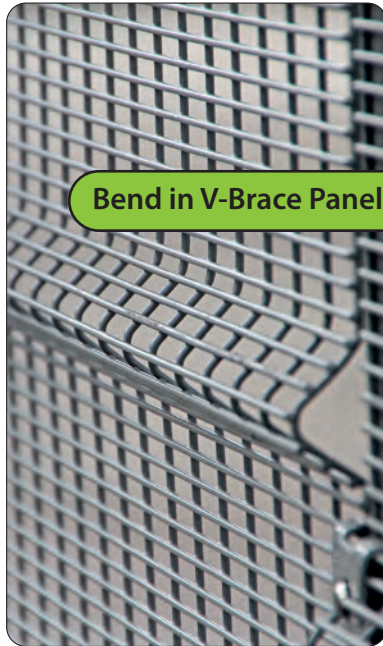

Bend in V-Brace Panel

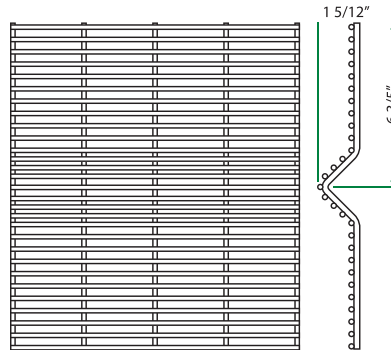

2 Styles! V-Brace or Flat

V-Brace Panel

ITEM#	DIMENSIONS	COLOR
FW63221	96"H X 98"W	Gray
FW63219	96"H X 98"W	Black

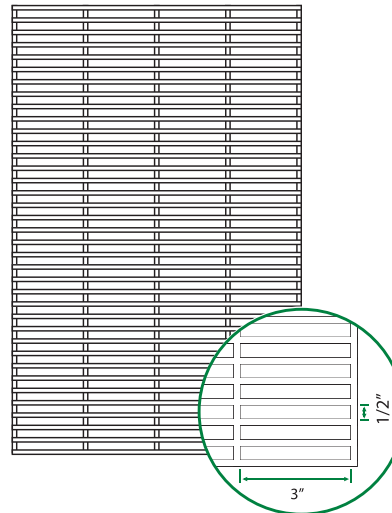

Flat Panel

ITEM#	DIMENSIONS	COLOR
FW63179	79"H X 98"W	Gray
FW63177	79"H X 98"W	Black

NOTE
Not All Items Stocked at All Locations.
Some Items May be Shipped to Store for Pickup

IN STOCK

BLACK | GRAY

SPECIAL ORDER

BROWN | WHITE | BLUE
YELLOW | RED | GREEN



Add Flat Panel to Existing Gate for Added Security



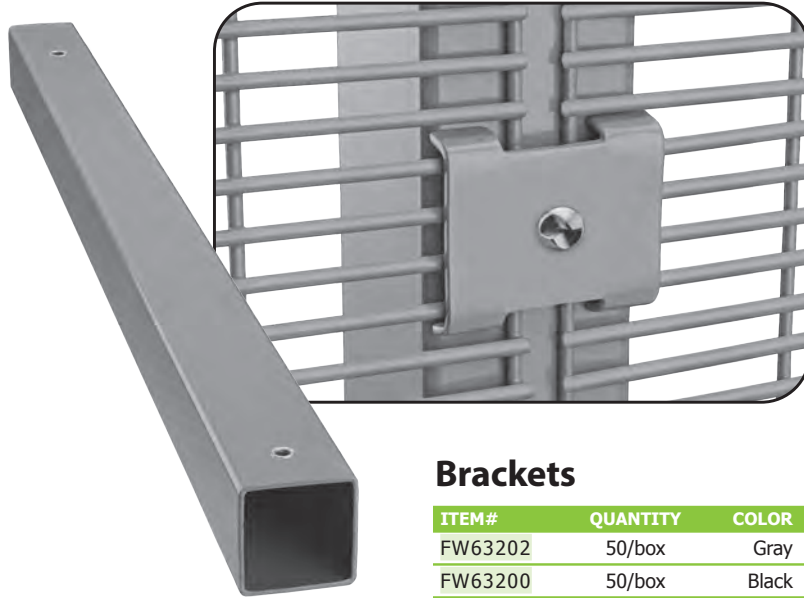
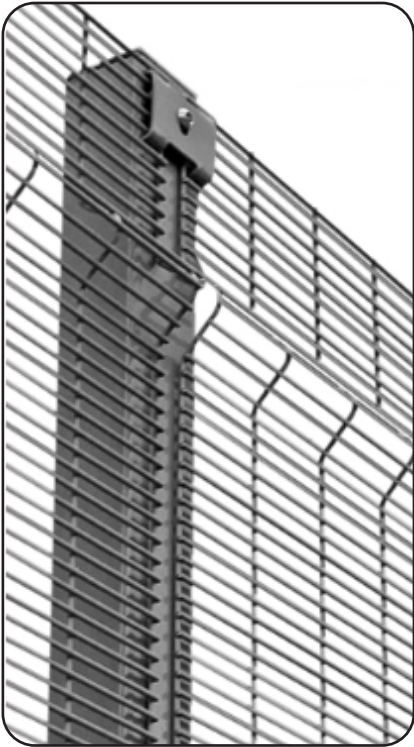

Brackets

ITEM#	QUANTITY	COLOR
FW63202	50/box	Gray
FW63200	50/box	Black

Posts for Forte Panels

ITEM#	DIMENSIONS	COLOR
FW12993	132"	Gray
FW12817	132"	Black



All Designmaster Fence Products Qualify for LEED Credits Needed to Achieve LEED Certification

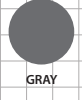
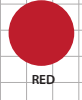
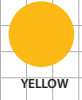
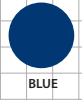
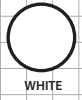
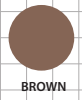
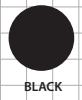
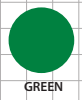

Brackets are required for each post as follows:

V Brace Panel

Posts for 96 in. Panel = 6

Flat Panel

Posts for 79 in. Panel = 5

This is a guideline for a fence installed on a flat, level terrain. Additional brackets may be required for specific projects, such as sloped installations.

The Forte Offers a High Level of Security with Its Strong and Virtually Impenetrable Design



1/2" x 3" Openings

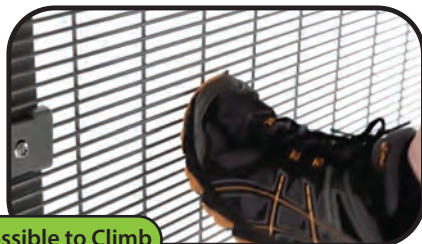

Nearly Impossible to Climb



Designed to be Tamper Resistant



LEED

All Designmaster Fence Products Qualify for LEED Credits Needed to Achieve LEED Certification



GREEN



BLACK



BROWN



WHITE



BLUE



YELLOW



RED



GRAY



GALVANIZED



NOTE:
This is an Extruded Aluminum Post

Post

ITEM#	DIMENSIONS	COLOR
FW63687	90"H, for 63.6"H Panel	Brown
FW62687	90"H, for 63.6"H Panel	Black
FW63671	109.2"H, for 79.2"H Panel	Brown
FW62637	109.2"H, for 79.2"H Panel	Black



Round Lock Clamp Square Lock Clamp



Single Clamp

Each Panel Requires:

2 Round Lock Clamps

4 Square Lock Clamps

4 Single Clamps

Accessories

ITEM	ITEM#	COLOR
Round Lock Clamp	FW62741	Brown
Round Lock Clamp	FW62740	Black
Squared Lock Clamp	FW62739	Brown
Squared Lock Clamp	FW62737	Black
Single Clamp	FW78769	Brown
Single Clamp	FW78766	Black

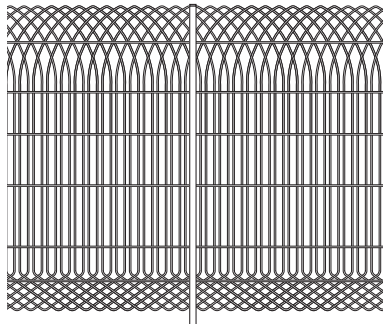

Milan Fence Panel & Accessories

- » Corners may require the use of two posts set side-by-side.
- » Posts are only available for In-Ground installation, Base mount is NOT offered for solid surface installation.

NOTE

Not All Items Stocked at All Locations.
Some Items May be Shipped to Store for Pickup

IN STOCK

BLACK | BROWN

SPECIAL ORDER

GRAY | WHITE | BLUE
YELLOW | RED | GREEN



Panel

ITEM#	DIMENSIONS	COLOR
FW62682	63.6"H X 87.4"W	Brown
FW62681	63.6"H X 87.4"W	Black
FW62683	79.2"H X 87.4"W	Brown
FW62668	79.2"H X 87.4"W	Black

Florence Fence Panel & Accessories

- » Corners may require the use of two posts set side by side.
- » Base Mount is only needed when Post is not required to be set in ground.

NOTE

Not All Items Stocked at All Locations.
Some Items May be Shipped to Store for Pickup

IN STOCK

BLACK | BROWN

WHITE | GREEN

SPECIAL ORDER

GRAY | BLUE

YELLOW | RED



Post

ITEM#	DIMENSIONS	COLOR
FW63677	55.2"H, for 31.2"H Panel	Green
FW63676	55.2"H, for 31.2"H Panel	White
FW63659	70.8"H, for 48"H Panel	Green
FW62638	70.8"H, for 48"H Panel	Brown
FW62686	70.8"H, for 48"H Panel	Black



Round Lock Clamp



Square Lock Clamp



Single Clamp



Base

Each Panel Requires:

4 Round Lock Clamps

2 Single Clamps

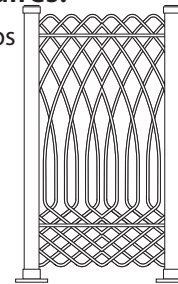

Accessories

ITEM	ITEM#	COLOR
Round Lock Clamp	FW63167	Green
Round Lock Clamp	FW62741	Brown
Round Lock Clamp	FW62740	Black
Round Lock Clamp	FW62996	White
Square Lock Clamp	FW78768	Green
Square Lock Clamp	FW62739	Brown
Square Lock Clamp	FW62737	Black
Square Lock Clamp	FW78767	White
Single Clamp	FW78768	Green
Single Clamp	FW78769	Brown
Single Clamp	FW78766	Black
Single Clamp	FW78767	White
Base	FW63286	Green
Base	FW63288	Brown
Base	FW63289	Black
Base	FW63287	White



Panel

ITEM#	DIMENSIONS	COLOR
FW63766	31.2"H X 96"W	Green
FW63773	31.2"H X 96"W	White
FW63782	48"H X 96"W	Green
FW62636	48"H X 96"W	Brown
FW62679	48"H X 96"W	Black

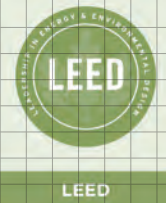

All Designmaster Fence Products Qualify for LEED Credits Needed to Achieve LEED Certification



GREEN



BLACK



BROWN



WHITE



BLUE



YELLOW



RED



GRAY



GALVANIZED

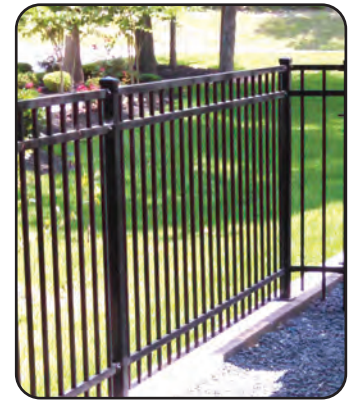

Black Flat Top/ Extended Bottom Two Rail Panel

*Fully rackable to 4 ft.
on 8 ft. run*

- » Two 16 ga. galvanized and powder-coated 1-3/16" x 1" channel rails with flat top and extended bottom.
- » 5/8" 18 ga. galvanized and powder-coated tubular steel pickets, 4-1/2" on center, 3-7/8" picket opening.

**1" Rails,
5/8" Pickets**

**For Installation On
Flat Runs Or Inclines!**

BLACKSMITH BRAND

ITEM #	APPROX. SIZE	DIMS.	MATCHING GATE
GANVFT24894	4'x8'	46" H x 90-1/2"W	GANVFT24848
GANVFT26094	5'x8'	58" H x 90-1/2"W	N/A



Black Flat Top/ Extended Bottom Three Rail Panel

*Fully rackable to 4 ft.
on 8 ft. run*

- » Three 16 ga. galvanized and powder-coated 1-3/16" x 1" channel rails with flat top and extended bottom.
- » 5/8" 18 ga. galvanized and powder-coated tubular steel pickets, 4-1/2" on center, 3-7/8" picket opening.

**1" Rails,
5/8" Pickets**

**For Installation On
Flat Runs Or Inclines!**

BLACKSMITH BRAND

ITEM #	APPROX. SIZE	DIMS.	MATCHING GATE
GANVFT34894	4'x8'	46" H x 90-1/2"W	GANVFT34848 & GANVFT34848ARC
GANVFT36094	5'x8'	58" H x 90-1/2"W	GANVFT36048
GANVFT37294	6'x8'	70" H x 90-1/2"W	GANVFT37248 & GANVFT37248ARC

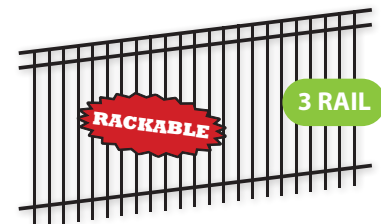

Black Flat Top/ Extended Bottom Three Rail Panel

Fully rackable to 4 ft. on 8 ft. run

- » Three 14 ga. galvanized and powder-coated 1-9/16" x 1-3/16" channel rails with flat top and extended bottom.
- » 3/4" 16 ga. galvanized and powder-coated tubular steel pickets, 4-5/8" on center, 3-7/8" picket opening.

**1-1/2" Rails,
3/4" Pickets**

**For Installation On
Flat Runs Or Inclines!**

BLACKSMITH BRAND

ITEM #	APPROX. SIZE	DIMS.	MATCHING GATE
GANVCFT34690	4'x8'	46" H x 90.5"W	GANVCFT3
GANVCFT35890	5'x8'	58" H x 90.5"W	N/A
GANVCFT37090	6'x8'	70" H x 90.5"W	N/A





Black Extended Top/ Extended Bottom Two Rail Panel

Fully rackable to 4 ft. on 8 ft. run

- » Two 16 ga. galvanized and powder-coated 1-3/16" x 1" channel rails with extended top and extended bottom.
- » 5/8" 18 ga. galvanized and powder-coated tubular steel pickets, 4-1/2" on center, 3-7/8" picket opening.

**1" Rails,
5/8" Pickets**

For Installation On
Flat Runs Or Inclines!



ITEM #	APPROX. SIZE	DIMS.	MATCHING GATE
GANVEXT24894	4' x 8'	46" H x 90-1/2"W	GANVEXT24848
GANVEXT26094	5' x 8'	58" H x 90-1/2"W	GANVEXT26048

Black Extended Top/ Extended Bottom Three Rail Panel

Fully rackable to 4 ft. on 8 ft. run

- » Three 16 ga. galvanized and powder-coated 1-3/16" x 1" channel rails with extended top and extended bottom.
- » 5/8" 18 ga. galvanized and powder-coated tubular steel pickets, 4-1/2" on center, 3-7/8" picket opening.

**1" Rails,
5/8" Pickets**

For Installation On
Flat Runs Or Inclines!



ITEM #	APPROX. SIZE	DIMS.	MATCHING GATE
GANVEXT34894	4' x 8'	46" H x 90-1/2"W	GANVEXT34848
GANVEXT36094	5' x 8'	58" H x 90-1/2"W	GANVEXT36048
GANVEXT37294	6' x 8'	70" H x 90-1/2"W	GANVEXT37248

Black Extended Top/ Extended Bottom Three Rail Panel

Fully rackable to 4 ft. on 8 ft. run

- » Three 14 ga. galvanized and powder-coated 1-9/16" x 1-3/16" channel rails with flat top and extended bottom.
- » 3/4" 16 ga. galvanized and powder-coated tubular steel pickets, 4-5/8" on center, 3-7/8" picket opening.

**1-1/2" Rails,
3/4" Pickets**

For Installation On
Flat Runs Or Inclines!



ITEM #	APPROX. SIZE	DIMS.	MATCHING GATE
GANVCEXT35890	5' x 8'	58" H x 90.5"W	N/A
GANVCEXT37090	6' x 8'	70" H x 90.5"W	GANVCEXT37048
GANVCEXT39490	8' x 8'	94" H x 90.5"W	N/A

Black Flat Top/Extended Bottom Four Rail Panel with Puppy Panel

Includes Puppy Panel

Fully rackable to 4 ft. on 8 ft. run

- » Four 16 ga. galvanized and powder-coated 1-3/16" x 1" channel rails with flat top and extended bottom
- » 5/8" 18 ga. galvanized and powder-coated tubular steel pickets, 4-1/2" on center, 3-7/8" picket opening



**1" Rails,
5/8" Pickets**

**For Installation On
Flat Runs Or Inclines!**

BLACKSMITH BRAND

*Keep Your Pets
from Getting
Out*

or Into Unsafe Areas

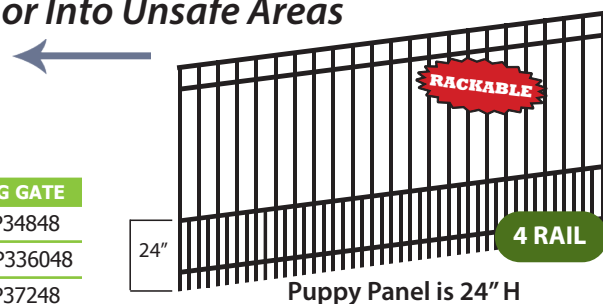
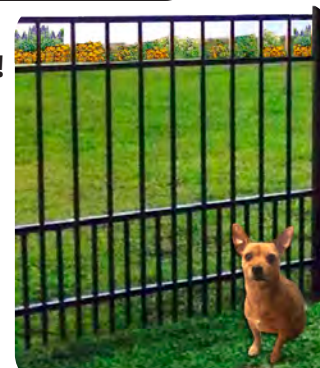

ITEM #	APPROX. SIZE	DIMS.	MATCHING GATE
GANVFTPP34894	4'x8'	46" H x 90-1/2"W	GANVFTPP34848
GANVFTPP36094	5'x8'	58" H x 90-1/2"W	GANVFTPP336048
GANVFTPP37294	6'x8'	70" H x 90-1/2"W	GANVFTPP37248

Black Flat Top/ Flat Bottom Three Rail Panel

*Fully rackable to 4 ft.
on 8 ft. run*

- » Three 16 ga. galvanized and powder-coated 1-3/16" x 1" channel rails with flat top and flat bottom.
- » 5/8" 18 ga. galvanized and powder-coated tubular steel pickets, 4-1/2" on center, 3-7/8" picket opening.

**1" Rails,
5/8" Pickets**

**For Installation On
Flat Runs Or Inclines!**

BLACKSMITH BRAND



ITEM #	APPROX. SIZE	DIMS.	MATCHING GATE
GANVFTFB34894	4'x8'	46" H x 90-1/2"W	GANVFTTB34848
GANVFTFB36094	5'x8'	58" H x 90-1/2"W	GANVFTTB36048
GANVFTFB37294	6'x8'	70" H x 90-1/2"W	GANVFTTB37248

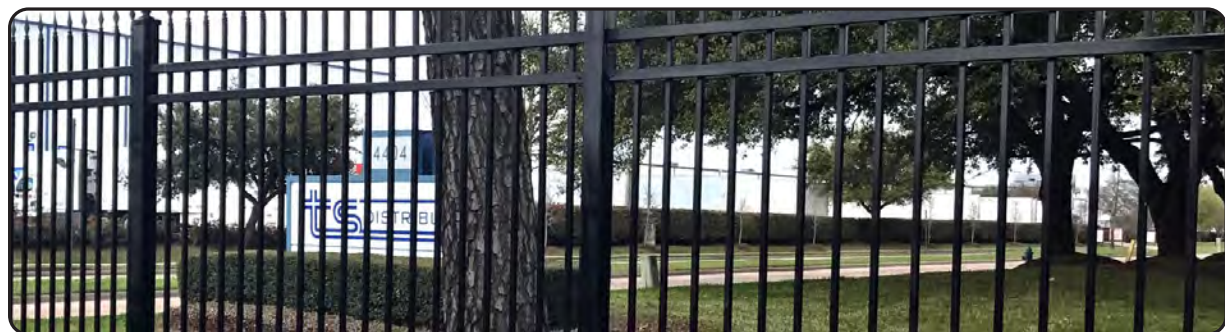



Black Pressed Spear Top/ Extended Bottom Three Rail Panel

*Fully rackable to 4 ft.
on 8 ft. run*

- » Three 16 ga. galvanized and powder-coated 1-3/16" x 1" channel rails with pressed spear top/extended bottom.
- » 5/8" 18 ga. galvanized and powder-coated tubular steel pickets, 4-1/2" on center, 3-7/8" picket opening.

**1" Rails,
5/8" Pickets**

**For Installation On
Flat Runs Or Inclines!**

BLACKSMITH BRAND



3 RAIL

ITEM #	APPROX. SIZE	DIMENSIONS	MATCHING GATE
GANVSP34894	4' x 8'	46"H x 90-1/2"W	GANVSP34848
GANVSP36094	5' x 8'	58"H x 90-1/2"W	GANVSP36048
GANVSP37294	6' x 8'	70"H x 90-1/2"W	GANVSP37248

Black Pressed Spear Top Extended Bottom Three Rail Panel

- » Fully rackable to 4 ft. on 8 ft. run
- » Three 14 ga. galvanized and powder-coated 1-9/16" x 1-3/16" channel rails with flat top/extended bottom.
- » 3/4" 16 ga. galvanized and powder-coated tubular steel pickets, 4-5/8" on center, 3-7/8" picket opening.

**1-1/2" Rails,
3/4" Pickets**

**For Installation On
Flat Runs Or Inclines!**

BLACKSMITH BRAND



3 RAIL

ITEM #	APPROX. SIZE	DIMENSIONS	MATCHING GATE
GANVCSP37090	6'x8'	70"H x 90.5"W	GANVCSP37048
GANVCSP39490	8'x8'	94"H x 90.5"W	N/A

Black Pressed Curved Top Extended Bottom Three Rail Panel

- » Three 14 ga. galvanized and powder-coated 1-9/16" x 1-3/16" channel rails.
- » 3/4" 16 ga. galvanized & powder-coated tubular steel pickets, 4-5/8" on center, 3-7/8" picket opening.

**1-1/2" Rails,
3/4" Pickets**

**For Installation On
Flat Runs Or Inclines!**

BLACKSMITH BRAND



3 RAIL

ITEM #	DIMENSIONS
GANVCCUR39490	94" H X 90.5 W

Ornamental Walk Gates

POWDER-COATED

Flat Top 3 Rail Gates

- » Three 1-9/16" x 1-3/16" channel rails with flat top and extended bottom
- » 3/4" tubular steel pickets, 4-5/8" on center, 3-7/8" picket opening

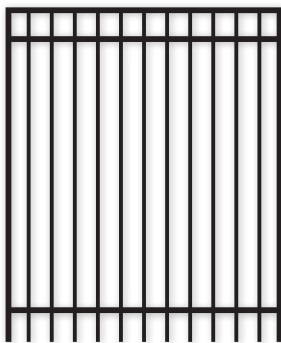

BLACKSMITH BRAND

ITEM #	DIMENSIONS
GANVCFT34648	46" H x 46-1/2" W

Extended Top 3 Rail Gates

- » Three 1-9/16" x 1-3/16" channel rails with extended top and bottom
- » 3/4" tubular steel pickets, 4-5/8" on center, 3-7/8" picket opening

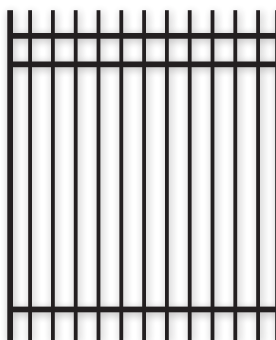

BLACKSMITH BRAND

ITEM #	DIMENSIONS
GANVCEXT37048	70" H x 46-1/2" W

Pressed Spear Top 3 Rail Gates

- » Three 1-9/6" x 1-3/16" channel rails with pressed spear top and extended bottom
- » 3/4" tubular steel pickets, 4-5/8" on center, 3-7/8" picket opening



BLACKSMITH BRAND

ITEM #	DIMENSIONS
GANVCSP37048	70" H x 46-1/2" W

Ornamental Walk Gates

POWDER-COATED

Arched Top 3 Rail Gates

- » Three 1-3/16" x 1" curved channel rails with flat top and extended bottom
- » 5/8" tubular steel pickets, 4-1/2" on center, 3-7/8" picket opening

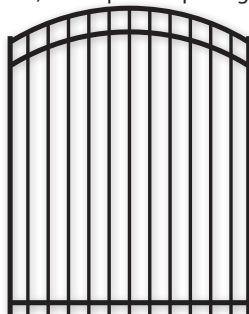

BLACKSMITH BRAND

ITEM #	DIMENSIONS
GANVFT34848ARC	46" H x 46-1/2" W
GANVFT37248ARC	70" H x 46-1/2" W

Pressed Spear Top 3 Rail Gates

- » Three 1-3/6" x 1" channel rails with pressed spear top and extended bottom
- » 5/8" tubular steel pickets, 4-1/2" on center, 3-7/8" picket opening

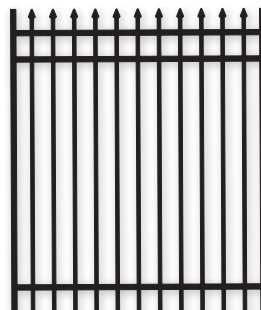

BLACKSMITH BRAND

ITEM #	DIMENSIONS
GANVSP34848	46" H x 46.5" W
GANVSP36048	58" H x 46.5" W
GANVSP37248	70" H x 46.5" W

1" Rails, 5/8" Pickets

*Extensive Selection of
Gate Hinges and
Latches Begins on
Page 22*



Ornamental Walk Gates

POWDER-COATED

Flat Top 2 Rail Gate

- » Two 1-3/16" x 1" channel rails with flat top and extended bottom
- » 5/8" tubular steel pickets, 4-1/2" on center, 3-7/8" picket opening

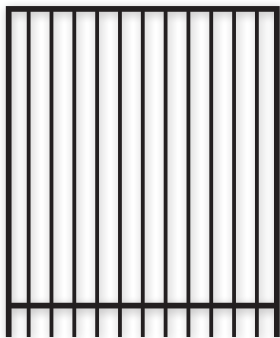

BLACKSMITH BRAND

ITEM #	DIMENSIONS
GANVFT24848	46" H x 46-1/2" W

Extended Top 2 Rail Gate

- » Two 1-3/16" x 1" channel rails with extended top and bottom
- » 5/8" tubular steel pickets, 4-1/2" on center, 3-7/8" picket opening

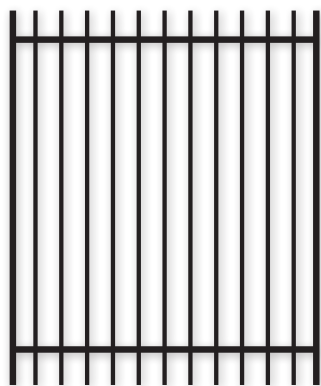

BLACKSMITH BRAND

ITEM #	DIMENSIONS
GANVEXT24848	46" H x 46-1/2" W

Flat Top 3 Rail Gates

- » Three 1-3/16" x 1" channel rails with flat top and extended bottom
- » 5/8" tubular steel pickets, 4-1/2" on center, 3-7/8" picket opening

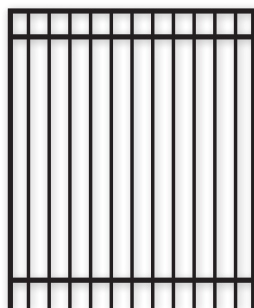

BLACKSMITH BRAND

ITEM #	DIMENSIONS
GANVFT34848	46" H x 46-1/2" W
GANVFT36048	58" H x 46-1/2" W
GANVFT37248	70" H x 46-1/2" W

Extended Top 3 Rail Gates

- » Three 1-3/16" x 1" channel rails with extended top and bottom
- » 5/8" tubular steel pickets, 4-1/2" on center, 3-7/8" picket opening

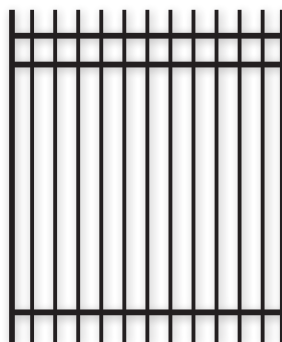

BLACKSMITH BRAND

ITEM #	DIMENSIONS
GANVEXT34848	46" H x 46-1/2" W
GANVEXT36048	58" H x 46-1/2" W
GANVEXT37248	70" H x 46-1/2" W

1" Rails, 5/8" Pickets

Flat Top 3 Rail Gates

- » Three 1-3/16" x 1" channel rails with flat top and flat bottom
- » 5/8" tubular steel pickets, 4-1/2" on center, 3-7/8" picket opening

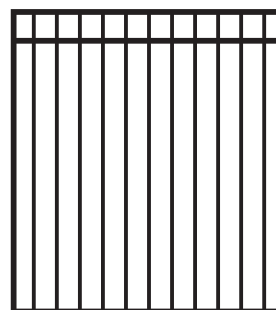

BLACKSMITH BRAND

ITEM #	DIMENSIONS
GANVFTFB34848	46" H x 46-1/2" W
GANVFTFB36048	58" H x 46-1/2" W
GANVFTFB37248	70" H x 46-1/2" W

Flat Top 4 Rail Gates *Includes Puppy Panel*

- » Four 1-3/16" x 1" channel rails with flat top and extended bottom
- » 5/8" tubular steel pickets, 4-1/2" on center, 3-7/8" picket opening

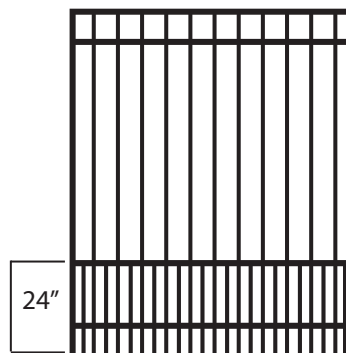

BLACKSMITH BRAND

ITEM #	DIMENSIONS
GANVFTPP34848	46" H x 46-1/2" W
GANVFTPP36048	58" H x 46-1/2" W
GANVFTPP37248	70" H x 46-1/2" W

Galvanized Black Powder-Coated Posts

Post Fits All Welded & Rackable Black Powder-Coated Fence Panels

Posts Sold Individually

Available In:

2" 2.5" 3" 4"

- » 2" and 2.5" posts are 16 gauge
- » 3" posts are 14 gauge
- » 4" posts are 11 gauge

ITEM#	SIZE
GP2164	2" x 4'
GP2166	2" x 6'
GP2167	2" x 7'
GP2168	2" x 8'
GP2169	2" x 9'
GP21611	2" x 11'



ITEM#	SIZE
GP212166	2.5" x 6'
GP212167	2.5" x 7'
GP212168	2.5" x 8'
GP212169	2.5" x 9'

ITEM#	SIZE
GP3148	3" x 8'
GP31410	3" x 10'
GP41110	4" x 10'

Find 3 Styles of **BOLT-ON Fork Latches** at the Top of Page 41



Galvanized Black Powder-Coated Post with Square Flange

Mount Above Ground to Wood or Concrete Surfaces



Flange is **4" x 4"** with **7/16"** Holes

Available in 3 Sizes

- » 16 gauge
- » Fits Welded or Rackable



ITEM#	SIZE
GP2164FLG	2" x 4'
GP2165FLG	2" x 5'
GP2166FLG	2" x 6'

Fast 2K



Fast Setting Foam for Posts

The Alternative to Concrete for Setting Fence Posts in Less than 15 Minutes



- » Mixes in 30 Seconds & Sets within 15 Minutes
- » Waterproof Protection - Does Not Absorb Water Like Concrete
- » Adheres to Metal, Wood & Vinyl Posts
- » No Hauling Heavy Concrete Bags
- » No Water Needed & No Messy Mixing
- » One Bag = 100 lb of Concrete

ITEM #
MCSAFSF



Galvanized Black Powder-Coated Upright Gate End Posts

1.5"

Powder-Coated 16 ga. Steel Square Tube

Used to Make Custom Gates



ITEM #	SIZE
GEND4	1.5" x 4 ft.
GEND5	1.5" x 5 ft.
GEND6	1.5" x 6 ft.
GEND7	1.5" x 7 ft.

Post Flange Bracket

Black Powdercoat Over Galvanized Steel

- » Fits 2" X 16 GA. square post
- » Flange plate measures 4" X 4" with four 3/8" holes



ITEM #	UOM	POST SIZE
GE3FP	Each	2"

Tek-Screws

- » Self-drilling
- » Hex head tek screws
- » Plated head or black painted headed



ITEM #	TYPE	SIZE	COLOR
RA14141BLK	Tek	1/4" x 1"	Black
RA14141	Tek	1/4" x 1"	Plated

Works with Rackable Panels

Line Bracket

» Powder-coated



*Fasteners included



ITEM #	UOM	DESCRIPTION
GANV1	Pair For 1"	Rail / 2" Post
GANVC1	Pair For 1-1/4"	Rail 2-1/2" Post

Universal Bracket

» Powder-coated

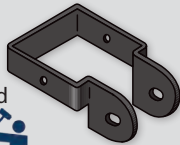

ITEM #	UOM	DESCRIPTION
GANV2	Each For 1" Rail / 2" Post	
GANVC2	Each For 1-1/4" Rail / 2-1/2" Post	

Flat Mount Bracket



» Fits any size post
» Powder-coated

ITEM #	UOM	DESCRIPTION
GANV3	Each For 1" Rail	
GANVC3	Each For 1-1/4" Rail	

Black Plastic Tube Plugs

» High grade plastic
» Keeps dirt and moisture out of tubes



ITEM #	UOM	TUBE SIZE	DESC.
PP12	Each	1/2"	Picket Plug
PPSQ58	Each	5/8"	Picket Plug
PPSQ6	Each	3/4"	Picket Plug
PPD210	Each	2"	Post Plug
PPSQ201	Each	2-1/2"	Post Plug
PPSQ6241	Each	3"	Post Plug

Not all items stocked at all locations.

Powder-Coated Swivel Bracket
Swivels to Either Side

» Fits any size fence post
» Works with **rackable panels**



Bracket & Fence Post Sold Separately

ITEM #	DESCRIPTION
GA719421204	Residential Fits 1" Rail
GA729421204	Commercial Fits 1-1/4" Rail

Black Powder-Coated Pressed Steel Post Caps

» Tight fitting, no welding necessary

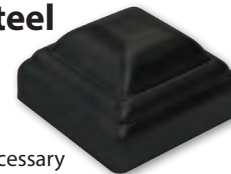

ITEM #	UOM	POST SIZE	DESC.
GPSC2GB	Ea.	2"	Steel Post Cap
GPSC212GB	Ea.	2-1/2"	Steel Post Cap
GPSC3GB	Ea.	3"	Steel Post Cap
GPSC4GB	Ea.	4"	Steel Post Cap

Black Post Caps

» Economical
» No painting necessary

Available in Plastic or Powder-Coated Cast Iron



Black Powder-Coated Cast Iron Post Caps

ITEM #	UOM	POST SIZE	DESC.
X118B	Each	2"	Ball Post Cap
X121B	Each	2-1/2"	Ball Post Cap
X120B	Each	3"	Ball Post Cap
X119B	Each	4"	Ball Post Cap

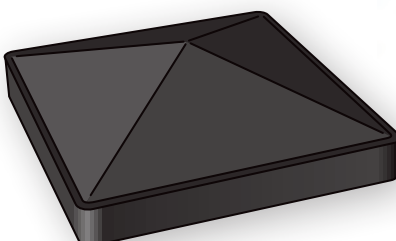

Black Plastic Post Caps

ITEM #	UOM	POST SIZE	DESC.
PS807B	Each	2"	Pyramid Post Cap
PS808B	Each	3"	Pyramid Post Cap

Black Plastic Finials

» High quality finial will not rust
» Molded from high grade plastic
» Fits 1/2" or 5/8" pickets



ITEM #	UOM	PICKET	DESC.
PSM25	Ea.	1/2"	Tri-Point Spear
PSM30	Ea.	1/2"	Ball Point Finial
PSM2558	Ea.	5/8"	Tri-Point Spear
PSM3058	Ea.	5/8"	Ball Point Finial

Black Finials

Available in plastic, cast iron or powder-coated cast iron

» Black finish
» Easy to install

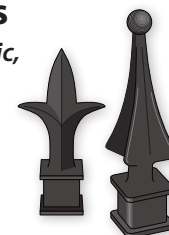

ITEM #	DESCRIPTION
PSM2534	3/4" Plastic Tri-Point
PSM34	3/4" Plastic Ball Point
X64934B	3/4" Powder-Coated Tri-Point
X9X34B	3/4" Powder-Coated Ball Point

NEW!

XL Bifold Kit for Swing Gate

This Kit Modifies a Swing Gate so that it Folds Automatically while Opening, which is a Great Solution for Entrances with Space Constraints

Trackless System that Can be Automated

Kit Includes

ADJUSTABLE CONNECTING ROD

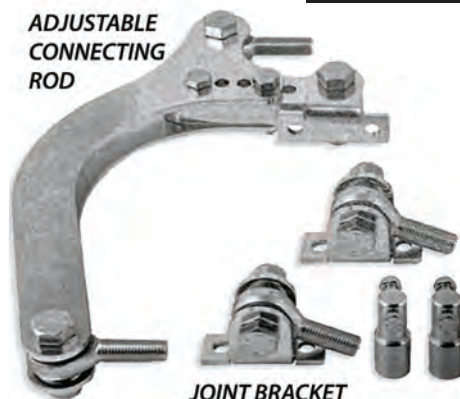

JOINT BRACKET

ADJUSTABLE PIVOT BRACKET



» Kit Parts are Galvanized Steel

Designed for Gate Leaves Up to 16 FT and 885 LBS



Swing Gate Folded and Open Using XL Bifold Kit

ITEM #

HAC500A XL Bifold Kit for Swing Gate

Find a Range of **NEW!** Hardware Items from the Brands You Trust
Here are a Few of the New Items You'll Find in Hardware

Kwikset



PAGE 46-47

The Latest Styles and Finishes

Now Stocking Weld Studs
Page 74

Choose from 5 SIZES



The 3-PRODUCT SOLUTION for a CLOSED GATE

The combination of the child-safe latch **FORTIMA**, the **CARACAL GATE CLOSER** and the **SERVAL SELF-CLOSING HINGE**, assures a closed gate at all times and offers a solution for both public and private pools.

Learn More on These Pages

GREAT SOLUTION at a GREAT PRICE



4" Steel Barrel Hinges (No Plate)

NEW!

Choose from 1" or 1-1/4" Diameter

Find on Page 27

Brass Grease Fitting



Aluminum Die Cast Dome Caps



Find All 4 SIZES on Page 78

For More Than 30 Years
Blacksmith Brand™ Weldable Gate Hinges Have Set the Standard!

- » Built To Last With High-Quality Machined Steel Construction
- » Easy To Lubricate With Built-In Grease Fittings



Medium 5"H x 1-1/2"W Gate Hinges

Up to
300 lb. Gate Capacity Per Pair



- » Machined from one piece of cold finish steel
- » Ball bearing for smooth operation

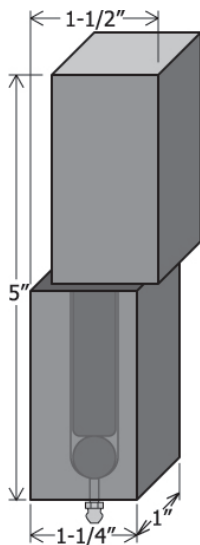

Sold in Pairs

ITEM #	DESCRIPTION
BHM	Medium 5" Hinge

Large 7"H x 2-1/8"W Gate Hinges

Up to
1000 lb. Gate Capacity Per Pair



- » Machined from one piece of cold finish steel
- » Ball bearing for smooth operation

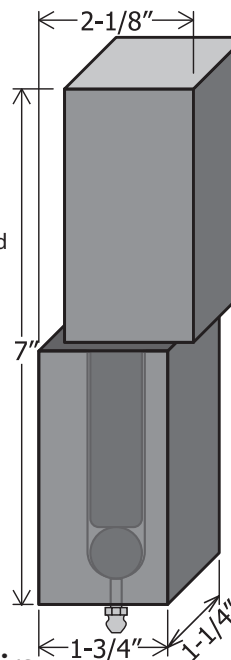

Sold in Pairs

ITEM #	DESCRIPTION
BHL	Large 7" Hinge

Extra Large 7"H x 3"W Gate Hinges

Up to
2500 lb. Gate Capacity Per Pair



- » Machined from one piece of cold finish steel
- » Ball bearing for smooth operation

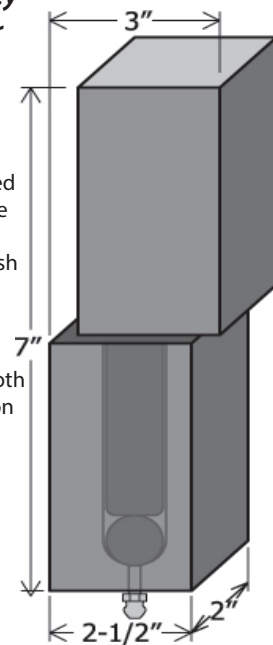

Sold in Pairs

ITEM #	DESCRIPTION
BHXL	Extra Large 3" Width 7" Hinge

Adjustable J-Bolt Hinge

Sold in Pairs



- » Hinge pivots on a steel ball bearing
- » Grease fitting to keep bearing lubricated
- » 5/8" steel J Bolt provides 4" of gate adjustability

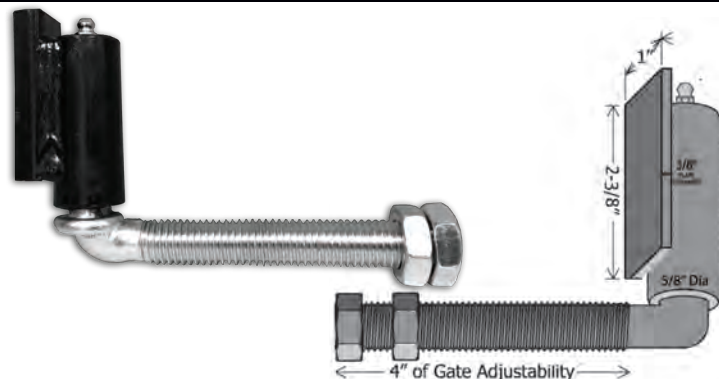

ITEM #	DESCRIPTION
HA258ADJ	Adjustable Hinge

The Smarter Choice – Premium Quality at the Right Price



Medium Adjustable Hinge Sold in Pairs



Up to 500 lb. Gate Capacity Per Pair

- » Machined from cold finished steel bar
- » Ball bearing for smooth operation
- » 5/8" J-Bolt provides 4" of gate adjustability

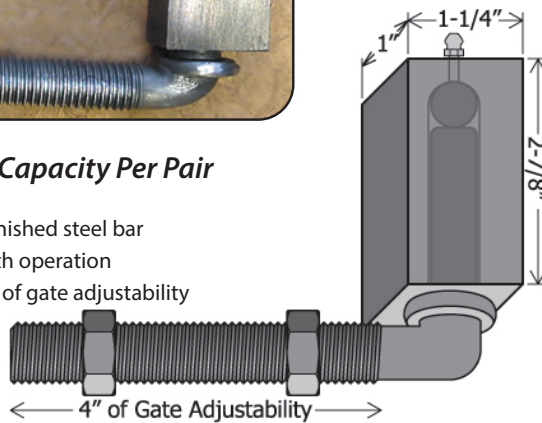

ITEM #	DESCRIPTION
BHMADJ	Medium Adjustable Hinge

Heavy Duty Roller Bearing Hinge

Up to 2000 lb.
Gate Capacity
Per Pair

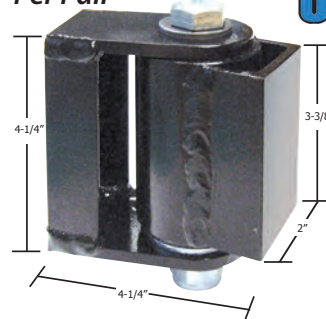

- » Sealed ball bearings are maintenance free, no lubrication required
- » 4-1/4" H x 2" W
- » 2-1/4" barrel diameter
- » 4-1/4" gate clearance
- » 10-1/2 lbs. per pair (hinge weight)

Sold in Pairs

ITEM #	DESCRIPTION
BHG9	Heavy Duty

Large Adjustable Hinge Sold in Pairs



- » Machined cold finished steel bar
- » Ball bearing for smooth operation
- » 7/8" diameter alloy threaded rod provides up to 7" of gate adjustability

Up to 900 lb. Gate Capacity Per Pair

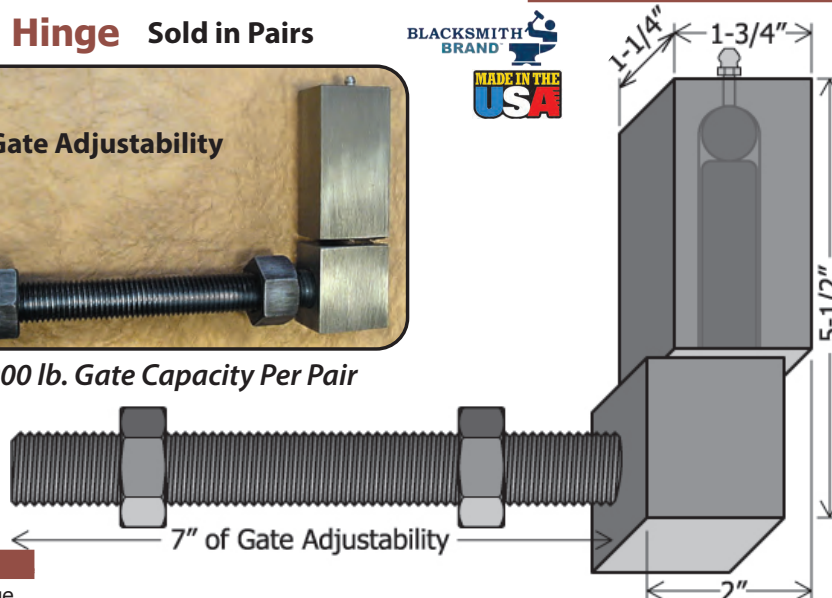

ITEM #	DESCRIPTION
BHLADJ	Large Adjustable Hinge

Bat Wing Clips



Two Sizes Available

Choose from Two Pin Hole Sizes - 1/2" or 5/8"

» Weldable non-adjustable hinges

Female Can be Used with Gate Hanger Bolts that have 1/2" or 5/8" Pin Dia or with the Male Clip

ITEM #	PIN/HOLE	DESCRIPTION
HA5M	1/2"	Male Bat Wing Clip
HA5	1/2"	Female Bat Wing Clip
HA558M	5/8"	Male Bat Wing Clip
HA558	5/8"	Female Bat Wing Clip

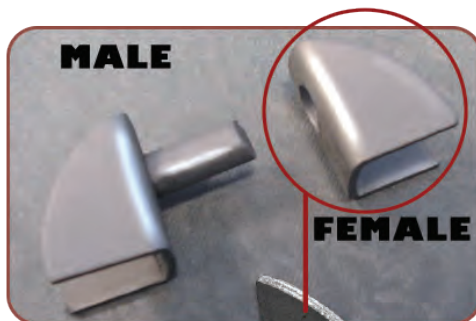

Male and Female Sold Separately

Economy Bolt-On Bat Wing Gate Hinges

Female Can be Used with Gate Hanger Bolts that have 1/2" Pin Dia



Male and Female Sold Separately

Black Powder-Coated Finish

» 1/2" diameter pin adds strength

Sold Individually

ITEM #	DESCRIPTION
HA5WTM	Male Bat Wing Hinge
HA5WTF	Female Bat Wing Hinge

Up Hill Steel Hinges

Able to Handle Gates Up to a Ton
Sold in Pairs



11-1/2" L x 8" H" Overall Size
3/4" Dia Steel Hinge Bolt

» For uphill swing up to 15°
» 3" x 10" x 1/2" thick weldable plates, bronze bearings

ITEM #	DESCRIPTION
HI775	Uphill Gate Hinges

Decorative Small Barrel Hinge

» 1/2" dia.
» Height: 3-7/8"
» 5/16" Pin
» Wt. .25 lb.



Sold Individually

ITEM #	DESCRIPTION
SF170B4	Decorative Barrel Hinge

NEW! Male / Female Bolt-On Hinges



MALE HINGE FITS:
2", 2-1/2", 3" Gate Posts



FEMALE HINGE FITS:
1-1/2", 2" Gate Frames

» Black gloss powder-coated steel

ITEM #	SIZE	DESCRIPTION
HIW2M	2"	Square Male Hinge
HIW212M	2-1/2"	Square Male Hinge
HIW3M	3"	Square Male Hinge
HIW2F	2"	Square Female Hinge
HIW112F	1-1/2"	Square Female Hinge

NEW! Adjustable Wood to Metal Gate Hanger Bolt



Galvanized Steel

Sold Individually

2 SIZES

ITEM #	PIN DIA.	PIN HT.	LENGTH
HA2LG	1/2"	1-1/2"	4-1/2"
HA258LG	5/8"	1-1/2"	4-1/2"

Adjustable Gate Hanger Bolt



Sold Individually

» Galvanized finish
» 1/2" or 5/8" bolt can be used with female bat wing hinge

ITEM #	PIN DIA.	PIN HT.	LENGTH
HA2	1/2"	1-1/2"	4-1/2"
HA258	5/8"	1-9/16"	4-1/2"
HA234	3/4"	1-3/4"	6"
HA25812	5/8"	2"	12"

PRODUCT LINE for USE on **WOOD**

Powder-Coated Hinges for Use on WOOD Gates

BLACKSMITH BRAND



Contempo Hinges

For Use on Wood



BLACKSMITH BRAND

Sold in Pairs

Now offered in 2 Sizes
8" or 10"

NEW!

» Black Powder-Coated

ITEM #	DESCRIPTION
HAJ100	8" Blk Powder-Coated Hinge
NEW! HAJ105	10" Blk Powder-Coated Hinge

Contempo Double Strap Hinges

For Use on Wood

2 Sizes
8" or 10"



BLACKSMITH BRAND

Sold in Pairs

» Black Powder-Coated
» Double strap

ITEM #	DESCRIPTION
HAJ115	8" Blk Powder-Coated Hinge
HAJ120	10" Blk Powder-Coated Hinge

8" Contempo Butterfly Hinges

For Use on Wood



BLACKSMITH BRAND

Sold in Pairs

» Black Powder-Coated

ITEM #	DESCRIPTION
HAJ140	8" Blk Powder-Coated Hinge

8" Traditional Hinges

BLACKSMITH BRAND

For Use on Wood



Sold in Pairs

» Black Powder-Coated

ITEM #	DESCRIPTION
HAJ150	8" Blk Powder-Coated Hinge

Ornamental 8" Self-Closing T-Hinges

BLACKSMITH BRAND

For Use on Wood



Sold in Pairs

8" High
8.85" Wide

» Black Powder-Coated

ITEM #	DESCRIPTION
HAJ130	8" Blk Powder-Coated Hinge

Ornamental 8" T-Hinges with Double Head Pin

BLACKSMITH BRAND

For Use on Wood



Sold in Pairs

7.89" High
9" Wide

» Black Powder-Coated

ITEM #	DESCRIPTION
HAJ110	8" Blk Powder-Coated Hinge



Wood Fence to Round Post Adaptors

BLACKSMITH BRAND

2-3/8" Aluminum Rail Bracket



2-3/8" Galvanized Steel Corner Post Adaptor



2-3/8" Galvanized Steel Corner Post Adaptor with Lip



2-3/8" or 2-7/8" Galvanized Steel Post Adaptor Line with Lip



ITEM #	DESCRIPTION
HAJ55	Aluminum 2-3/8" Rail Bracket

ITEM #	DESCRIPTION
HAJ52	2-3/8" Corner Post Adaptor
HAJ51	2-3/8" Corner Post Adaptor with Lip

ITEM #	DESCRIPTION
HAJ53	2-3/8" Steel Post Adaptor Line
HAJ54	2-7/8" Steel Post Adaptor Line

Narrow Width Weldable Steel Hinge

Sold in Pairs



- » Plain Steel
- » Blank (no holes)
- » Tight pin
- » .098 thick

ITEM #	SIZE
HI100	2-1/4" x 3-1/2"

Standard Duty Weldable Steel Hinge

Sold in Pairs

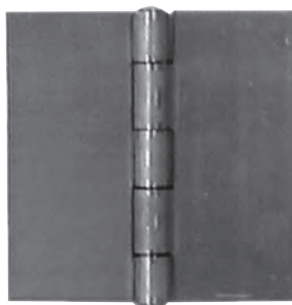

- » Plain Steel
- » Tight pin
- » Swaged
- » Blank (no holes)

ITEM #	SIZE
HI2S	2" x 2"
HI3S	3" x 3"
HI312S	3-1/2" x 3-1/2"
HI4S	4" x 4"

Extra Heavy Weldable Steel Hinge

Sold in Pairs

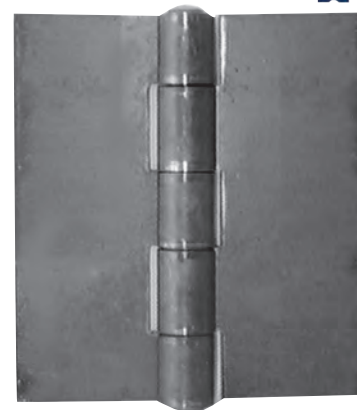

- » Plain Steel
- » Swaged
- » Tight pin
- » Blank (no holes)

ITEM #	SIZE
HI3H	3" x 3"
HI4H	4" x 4"
HI5H	5" x 5"
HI6H	6" x 6"

2.5" Aluminum Butt Hinge

Sold in Pairs

2.5" H X 2"W
.187 PIN / .81 THICK
» Mill Finish

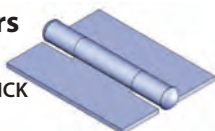

- » Resistant to corrosion; suited for indoor and outdoor applications

ITEM #	SIZE
HIA212	2.5" Aluminum Butt Hinge

4" Aluminum Butt Hinge

Sold in Pairs

4. W x 4" L
.276" PIN / .118 THICK
» Mill Finish

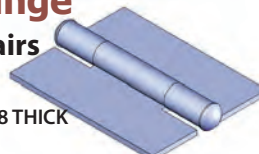

- » Resistant to corrosion; suited for indoor and outdoor applications

ITEM #	SIZE
HIA4	4" Aluminum Butt Hinge

Standard Weight Steel Hinge with Holes

Sold in Pairs

- » Tight-Pin
- » Screws not included



ITEM #	SIZE
HI312WH	3-1/2" x 3-1/2"

2" Stainless Steel Butt Hinge Sold in Pairs



2"H X 2"W .125 PIN .060 THICK
» Type 302/304 stainless steel; Include a 302/304 stainless steel pin

ITEM #	SIZE
HIS2	2" Stainless Steel Butt Hinge

3" Stainless Steel Butt Hinge Sold in Pairs



3"H X 2.5"W .125 PIN .62 THICK
» Type 302/304 stainless steel; Include a 302/304 stainless steel pin

ITEM #	SIZE
HIS3	3" Stainless Steel Butt Hinge

4" Stainless Steel Butt Hinge Sold in Pairs



4"H X 4"W .125 PIN .060 THICK
» Type 302/304 stainless steel; Include a 302/304 stainless steel pin

ITEM #	SIZE
HIS4	4" Stainless Steel Butt Hinge



Extra Heavy-Duty Industrial Hinge

Our Highest Capacity Hinge

7" Barrel Hinge with
3-1/8" Diameter



7" Barrel

Up to
3000 lb.
Gate
Capacity
Per Pair

1-1/4" Stainless
Steel Shaft

Grease Fitting
and Ball
Bearing
for Smooth
Operation

Sold in
Pairs

ITEM #

BHG11

Steel Barrel Hinges with Weldable Plate



5" Barrel

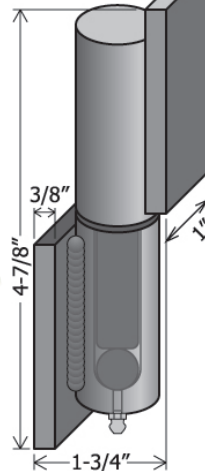

7" Barrel

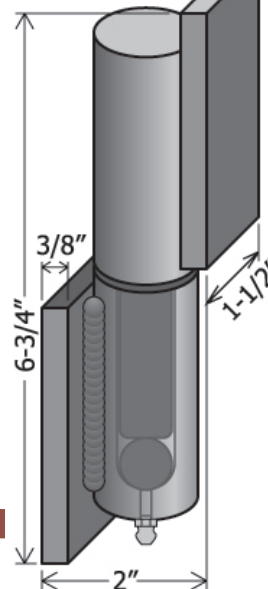

Sold in Pairs

- » Machined from high strength steel
- » Ball bearing for smooth operation
- » Weldable

ITEM #	GATE CAP.	DESCRIPTION
BHG5	400 lbs.	5" Barrel Hinge with Plate
BHG7	700 lbs.	7" Barrel Hinge with Plate

Tear Drop Weldable Hinge

Two Material Options



Hinge Length

Sold Individually

Stainless Steel Pin & Washer

NEW!

ITEM #	LENGTH
HIC55SS	3"
HIC66SS	5"

Plain Steel

ITEM #	LENGTH	GATE GAP
HIC4904	1-1/2"	1/2"
HIC4908	3"	5/8"
HIC4914	5-1/2"	3/4"

Steel Barrel Hinges

NEW!



2-3/8" in Three

Sold in Pairs Diameters

ITEM#	LENGTH	BAR CAPACITY
BH3	2-3/8"	3/8" 20 lbs.
BH6	2-3/8"	5/8" 30 lbs.
BH7	2-3/8"	1/2" 40 lbs.

Premium Steel Barrel Hinges

Machined from

Round Bar

» Designed for gates and doors

» Weldable

Sold in Pairs

ITEM #	LENGTH	BAR	CAPACITY
BHXS	2"	5/8"	75 lbs.
BHS	3"	3/4"	100 lbs.



3" Length

2" Length

4" Steel Barrel Hinges (No Plate)

NEW!



4" Barrel

Brass Grease Fitting

Choose from a
1" or 1-1/4" Dia

- » Machined from high strength steel
- » Ball bearing for smooth operation
- » Weldable

Sold in Pairs

ITEM #	DESCRIPTION
BH10	1" Dia X 4" H
BH11	1-1/4" Dia X 4" H

Fully Adjustable Specialty Hinge



3/4" Threaded Bolt
6-3/4" Total Length

ITEM #

HAC150M18

Sold Individually

Adjustable Hinge

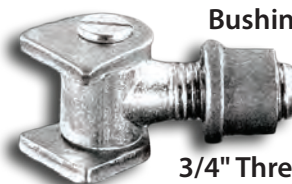

1" Weldable
Bushings

3/4" Threaded
Bolt

Sold Individually

ITEM #

HAC135M18

Adjustable XL 180° Weldable Hinge

Allows Door to Open 180°

Choice of 5/8" or 3/4"
Threaded Bolt



ITEM #

THREADED BOLT

HAC17812

5/8"

HAC17824

3/4"

Sold Individually

Adjustable Gate Hinge with Plate and Lock Nut

4" X 4" Bolt-On Plate

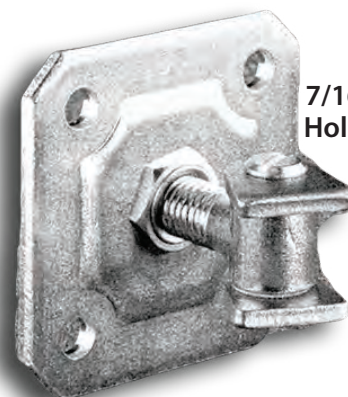

7/16"
Holes

Adjustable 3/4"
Hanger Bolt

Sold Individually

ITEM #

HAC163

Fully Adjustable Hinge with Bearing

Top & Base Plate Sold Individually

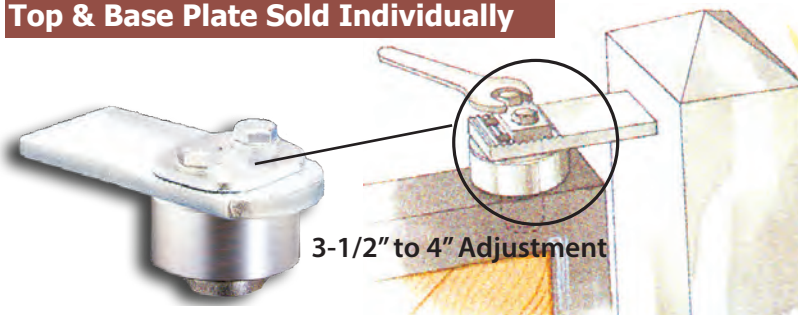

3-1/2" to 4" Adjustment

Base Plate Hinge with Thrust Bearings



1-1/2" H 2-5/8" Dia.
Static Load is 3950 lbs

ITEM #

DESCRIPTION

HAC86G

Hinge Top

HAC87G

Hinge Base



Stainless Flag Joint Hinge



2.38" W x 3" L
.250" PIN
.079 THICK

- » Hinges are made from 304SS
- » Both leaves are half swaged
- » Washer is welded to knuckle
- » No mounting holes allows for hinge to be welded to door

Sold Individually

ITEM #	DESCRIPTION
HIS2153	Stainless Flag Joint

6" Loose Joint Hinge



6" L X 6" W
.375" PIN

- » No mounting holes
- » Can be used when door removal is necessary
- » Made from cold rolled steel

Sold Individually

ITEM #	SIZE
HI6JL	LEFT Loose Joint Hinge
HI6JR	RIGHT Loose Joint Hinge

Steel Plug Hinge with Right or Left Wings



4-3/8" H
2-5/8" W

- » Halves are removable
- » Pin is fixed on one side

Sold Individually

ITEM #	THICKNESS	PIN	HAND
HIC430100L	11 ga	3/8"	Left
HIC430100R	11 ga	3/8"	Right

Large Hinge with Removable Pin

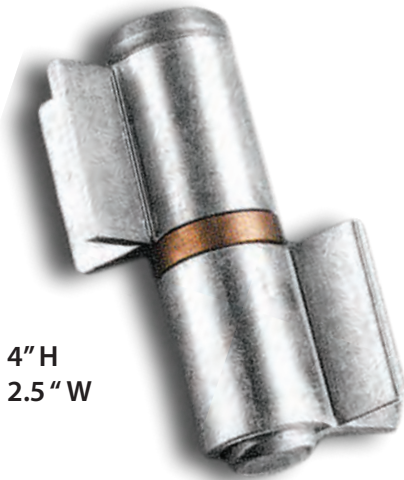

4" H
2.5" W

Sold Individually

ITEM #
HAC440

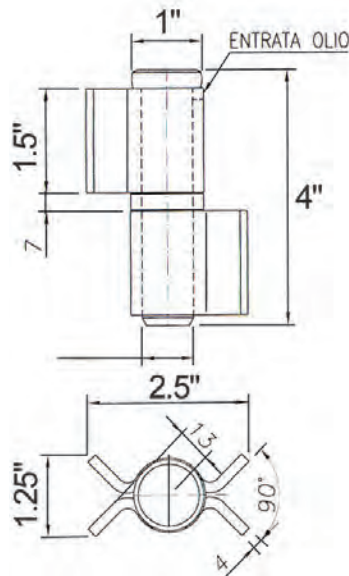

Adjustable Hinge with Weldable Wing

2-1/2" Weldable Bracket

1/2" Bolt

3-7/8" H

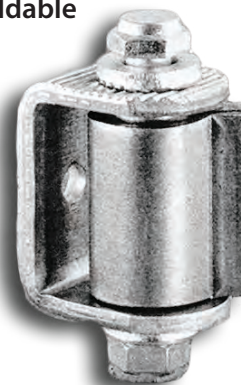

Adjusts from 2" to 2-1/2" from End of Bracket

Sold Individually

ITEM #
HAC90G

"H" Hinge BLACKSMITH BRAND

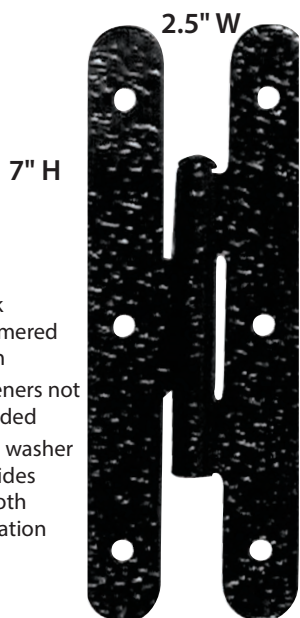

- » Black hammered finish
- » Fasteners not included
- » Steel washer provides smooth operation

Sold in Pairs

ITEM #	SIZE
H1H	7" H x 2-1/2" W

Zinc-Plated Strap Hinge With Brass Grease Fitting

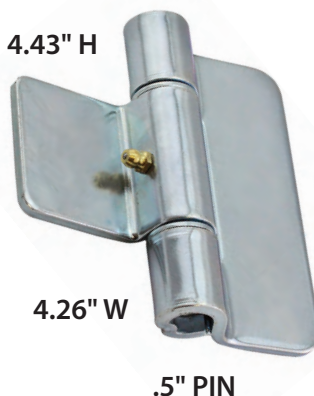

- » Zinc plating provides extra corrosion resistance

Sold Individually

ITEM #	DESCRIPTION
HIP3180	Strap Hinge w/Grease Fitting

Continuous Hinges

Available in:
Stainless Steel
Plain Steel
Aluminum

Choose from
4 Widths

Each is 72" Length

- » No Holes

Sold Individually



Latches Begin on Page 39



Heavy-Duty Zinc-Plated Strap Hinge

Left or Right Hand

Sold Individually



- » Vehicular strap hinge works well with applications requiring wide or heavy doors on sheds, trucks, trailers

ITEM #	HAND
HIM3L	LEFT Hand Strap Hinge
HIM3R	RIGHT Hand Strap Hinge

ITEM #	SIZE	THICK	MATL.
HIC72	1-1/2" x 72"	16 ga.	Steel
HIP27216	2" x 72"	16 ga.	Steel
HIPAL27216	2" x 72"	16 ga.	Alum.
HIPS27216	2" x 72"	16 ga.	Stainless
HIC372	3" x 72"	16 ga.	Steel
HIP372H	3" x 72"	11 ga.	Steel
HIP472H	4" x 72"	11 ga.	Steel
HIC472	4" x 72"	16 ga.	Steel

7.5 "Zinc-Plated Steel Bolt-On Hinge



2.90" to 3.40 Adjustable Width

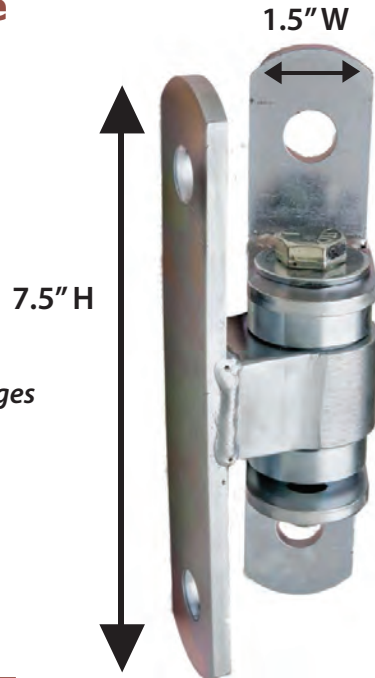

1000 lb Rating per Pair of Hinges

- » Two sealed roller bearings (no greasing)
- » Slotted yoke
- » Flat Bolt-on brackets

Sold in Pairs

ITEM #	DESCRIPTION
HI3700	Bolt-On Hinge

Bolt-On Baby Hinge

3.03" to 3.53 Adjustable Width

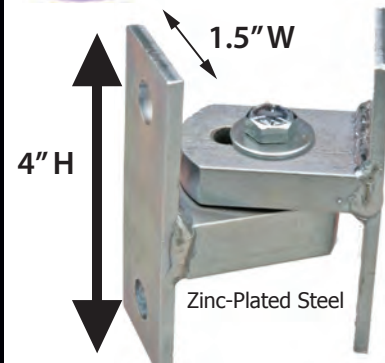

300 lb Rating per Pair of Hinges

- » Two sealed roller bearings (no greasing)
- » Slotted yoke for adjustability
- » Flat Bolt-on brackets

Sold in Pairs

ITEM #	DESCRIPTION
HI3720	Bolt-On Baby Hinge

Steel Hinge

ADJUSTABLE



Sold in Pairs

2000 lb Rating per Pair of Hinges

- » Two sealed roller bearings (no greasing)
- » Both round & flat post compatibility
- » Adjustable yoke
- » Zinc-plated; Weld-on installation
- » Lifetime Component replacement guarantee (5 years for bearings.)

ITEM #	DESCRIPTION
HI3000	Steel Hinge

Combo Aluminum & Steel Hinge

ADJUSTABLE

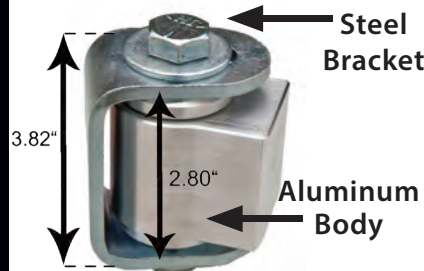

Sold in Pairs

1000 lb Rating per Pair of Hinges

- » Two sealed roller bearings (no greasing)
- » Both round & flat post compatibility
- » Slotted yoke for adjustability
- » Lifetime Component replacement guarantee (5 years for bearings.)

ITEM #	DESCRIPTION
HI3300	Combo Hinge

All Aluminum Hinge

ADJUSTABLE

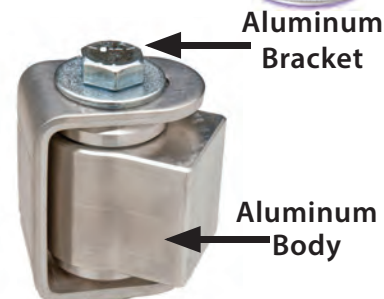

Sold in Pairs

1000 lb Rating per Pair of Hinges

- » Two sealed roller bearings (no greasing)
- » Slotted yoke for adjustability
- » Lifetime Component replacement guarantee (5 years for bearings.)

ITEM #	DESCRIPTION
HI3400	Aluminum Hinge



TruClose Self-Closing Hinges Sold in Pairs

TRU-CLOSE

ADJUSTABLE, SELF-CLOSING GATE HINGES



With or Without
Quick-Fit
Alignment
Legs



REINFORCING RIBS

Molded ribs provide superior torsional and lateral leaf strength.

STYLISH "FLAT" FINISH

Textured black finish gives a stylish, modern look.

STRENGTH AND STYLE

Subtle design features such as radius corners provides strength and style.



PATENTED ADJUSTOR

Depress for tension. Rises back into sleeve to retain tension.

INTERNAL STAINLESS STEEL SPRING

Provides even closing tension for gates.

MOLDED HINGE BODY

Strong & rust-free. UV-stabilized polymers with glass-fiber reinforcement.

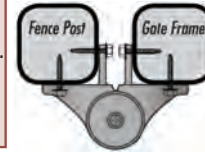

Measurement between hinge legs is 13/16 from outside to outside lips

Two legs provide secure, double-face fixing

Safety Cap



» Cap's steep ramp will deter a toddler from scaling fence or reaching the latch

ITEM #	DESCRIPTION
HITCACAPS3	STANDARD
HITCHDCAPS3	HEAVY-DUTY

CAP SOLD SEPARATELY

TCHD1A-MK2

Heavy Duty

Metal to Metal

- » No Fasteners included
- » Maxi Load: 700 lbs / 1000 lbs. w/ legs
- » Gate Weight: 132 lbs.



SHOWN HERE WITHOUT LEGS

ITEM#	COLOR	LEGS	DESCRIPTION
HIT1	Black	None	3-1/2" x 5"
HIT2	Black	Two	3-1/2" x 5"

TCA1-MK2

Regular Duty

Metal to Metal

- » No Fasteners included
- » Maxi Load: 450 lbs / 550 lbs. w/ legs
- » Gate Weight: 55 lbs.



SHOWN HERE WITHOUT LEGS

ITEM #	COLOR	LEGS	DESCRIPTION
HITCA1	Black	None	2-1/2" x 3-13/16"
HITCA1L2	Black	Two	2-1/2" x 3-13/16"

TCA2-MK2

Regular Duty

Metal to Wood

Metal to Metal

- » No Fasteners included
- » Maxi Load: 450 lbs / 550 lbs. w/ legs
- » Gate Weight: 55 lbs.



SHOWN HERE WITH LEGS

ITEM #	COLOR	LEGS	DIMENSIONS
HITCA2	Black	None	3-7/8" x 3-3/4"
HITCA2L2	Black	Two	3-7/8" x 3-3/4"

Aluminum Self Closing Gate Hinges Sold in Pairs

- » Powdered-coated aluminum hinges
- » D&D-patented tension adjustment
- » For gates up to 44 lbs
- » Wall and Post Mounting styles
- » Tested over 300,000 cycles
- » 2 year warranty

Find a Selection of D & D Latches on Pages 42-43



ITEM #	DESCRIPTION
HAKF3L2BL	Post Mounting Self Closing Gate Hinge
HAKF3ABL	Wall Mounting Self Closing Gate Hinge

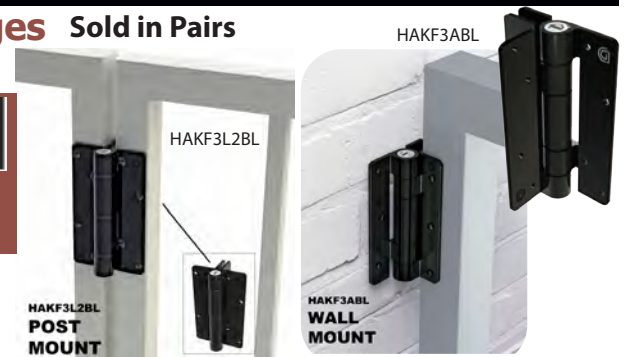

HAKF3L2BL
POST MOUNT

HAKF3ABL
WALL MOUNT



D SUREClose® READYFit

Hinge and Closer External Mount Power-Packed Hinge and Closer in One

This hinge and closer in one is hydraulic, compact, and heavy-duty. The perfect design for commercial, industrial, and estate gates.

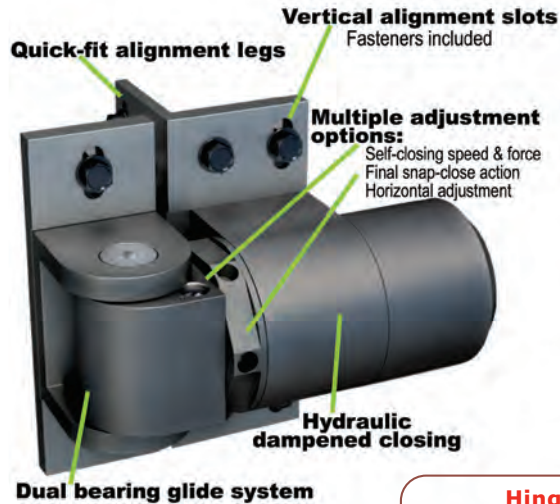

- » Easy install - No special tools or holes in post
- » Gap variance of 1/2" to 1 3/8"
- » Mounting bracket & fasteners included
- » Quick alignment legs
- » Non-removable adjustment nozzles
- » Designed for new and existing gates

Please Note: One of the following combinations using two hinges is needed for proper gate installation.

Self-Closing **180°** Swing Gate/Not Rated

**Hinge Combination for Self Closing
180 Degrees / 180 lb Gate Weight**

HA74108315 (ReadyFit Hinge/Closer)
with HA74001315 (ReadyFit Hinge Only)

**Hinge Combination for Self Closing
180 Degrees / 260 lb Gate Weight**

HA74108315 (ReadyFit Hinge/Closer)

MUST PURCHASE TWO HINGE/CLOSERS

Self-Closing **90°** Swing Gate

**Hinge Combination for Self Closing
90 Degrees / 180 lb Gate Weight**

HA74108325 (ReadyFit Hinge/Closer)
with HA74001315 (ReadyFit Hinge Only)

**Hinge Combination for Self Closing
90 Degrees / 260 lb Gate Weight**

HA74108325 (ReadyFit Hinge/Closer)

MUST PURCHASE TWO HINGE/CLOSERS

**EACH HINGE IS SOLD
SEPARATELY
NOT SOLD AS PAIRS**



ITEM #	DESCRIPTION
HA74108315	ReadyFit Hinge/Closer for 180° Swing
HA74108325	ReadyFit Hinge/Closer for 90° Swing
HA74001315	ReadyFit Hinge Only

Round Post Hinges

*Ideal for
Chain Link
Fence*

**Hinges Sold
in Pairs**



- » **Regular Duty:** Maximum load: 375 lbs. Gate Weight: 55 lbs.
Dimensions: HITCAMA2RND: 4" x 3-3/4"
- » **Heavy Duty:** Maximum load: 700 lbs. Gate Weight: 132 lbs.
Dimensions: HITCHDRND1: 4-1/8" x 5"
Dimensions: HITCHDRND2: 4-3/4" x 5"



ITEM #	DUTY	GATE FRAME
HITCAMA2RND	Regular	1-3/8" to 1-5/8"
HITCHDRND1	Heavy	1-3/8" to 1-5/8"
HITCHDRND2	Heavy	1-7/8" to 2"



The combination of the child-safe latch FORTIMA, the CARACAL GATE CLOSER and the SERVAL SELF-CLOSING HINGE, assures a closed gate at all times and offers a solution for both public and private pools.

See the Fortima Magnetic Latch on Page 42

LOCINOX®
The Caracal Hydraulic Gate Closer & Spring Hinge

Includes Both Pieces

- » Hydraulic damping **180° Opening**
- » Speed regulation
- » Soft close / Easy to open



For Gates Up to 140 LBS & 4 FT Wide

- » 13/16" vertical/ horizontal adjustability
- » Fiberglass reinforced polyamide housing
- » No welding required
- » For left & right opening gates

For Metal, Wood, and Vinyl Gates

Fits Square Posts

ITEM #	DESCRIPTION
LKCARACAL	180° Hydraulic Gate Closer & the Serval Spring Hinge

LOCINOX®
For Gates Up to 125 LBS & 4 FT Wide
Sold in Pairs



Serval Spring Hinges

- » 13/16" vertical/ horizontal adjustability
- » Adjustable closing force
- » Fiberglass reinforced polyamide housing
- » No welding required
- » For left & right opening gates
- » Functions in all weather conditions

ITEM #	DESCRIPTION
LKSERVAL	Pair of Spring Hinges

4" Double Acting Spring Hinges

- » For doors weighing up to 50 lbs. and from 1" to 1-1/2"
- » Primer gray finish is ready to paint
- » Great for high traffic doors that need to open in both directions and close automatically



Sold in Pairs

Includes wood screws and tool to adjust speed and tension

ITEM #
HIGH604DA

Spring Hinge For Automatic Closing of Doors

- » Single Acting



Sold in Pairs

ITEM #	SIZE
HI1250	3-1/2" x 3-1/2"

Self-Closing Hinge Set

ALL STEEL CONSTRUCTION



Set Includes:
 One Self-Closing Hinge
 One Non-Self-Closing Hinge

- » 5 tension adjustments
- » Round or flat post compatibility
- » Adjustable yoke
- » Maintenance-free bearings
- » Load rating: 2000 lbs.

ITEM #	DESCRIPTION
HI3850	Self-Closing Hinge Set

LOCINOX®
Mammoth Self-Closing Hinge Set

For Gates Up to 330 LBS & 4 FT Wide

Bottom Dino Hinge Included



180° Opening

- » Adjustable closing speed & pressure
- » For left & right opening gates
- » Double stainless steel bearing
- » 2-dimensionally adjustable, Gap & Height x 3/4"
- » Max opening force 3.5 lbs; conforms to all regulations
- » Burglar proof and anti-theft
- » Closing force over the full 180° opening angle
- » Closing speed unaffected by temperature changes
- » Easy mounting with Locinox Quick-Fix (Page 56)

ITEM #	DESCRIPTION
LKM2	Self-Closing Hinge Set

LOCINOX®
Tiger Compact Hinge & Gate Closer Set

For Gates Up to 220 LBS & 3FT Wide



180° Opening

- » Automatic closure with adjustable closing speed and final snap
- » Aluminum powder-coated PUMA hinge included
- » Powder-coated aluminum casing
- » Fast and easy mounting with Locinox Quick-Fix (Page 56)

ITEM #	DESCRIPTION
LKT9005	Compact Hinge & Closer Set

Verticlose - 2 Gate Closer **LOCINOX**[®] 2 Models Available - Gate or Wall

For Gates Up to 330 LBS and 5 ft Wide



- » Micro adjustment of speed & final snap
- » Perfect for outdoor use - Protected in powder-coated aluminum housing
- » Integrated pretension for smooth installation
- » Closing force over the full 180° opening angle
- » Firmly fixed thanks to patented Quick-Fix system (Page 56)

Railset Included
for Both 90°
and 180°



The specially designed arm turns around the wall or post, ensuring a large opening angle

ITEM #	DESCRIPTION
LKV2	Silver Mounts to Gate
LKV2WALL	Silver Mounts to Wall

TB200 Light-Duty Hydraulic Gate Closer

- » Gate Weight 50-125lbs.
- » Gate Width 36-52 in.
- » Opening Angle: 110 degrees
- » Vinyl, Steel or Wood Gate Material
- » Opening Pressure: Approx. 3-7 lbs.

NOW ALSO AVAILABLE
IN STAINLESS FINISH



ITEM #	DESCRIPTION	FINISH
HALTB200	Light-Duty Door Closer	BLACK
HALTB200SS	Light-Duty Door Closer	STAINLESS



TB400 Medium-Duty Hydraulic Gate Closer

- » Gate Weight 75-175 lbs.
- » Gate Width 40-64 in.
- » Opening Angle: 110 degrees
- » Opening pressure appx.: 6-12 lbs.
- » Gate material: vinyl, steel, wood
- » Automatic gate closer
- » Does not slam gates shut

NOW ALSO AVAILABLE
IN STAINLESS FINISH



ITEM #	DESCRIPTION	FINISH
HALTB400	Medium-Duty Door Closer	BLACK
HALTB400SS	Medium-Duty Door Closer	STAINLESS



Samson-2 Hydraulic Gate Closer **LOCINOX**[®]

Closes Gates Up
to 300 LBS and 6.56 Ft Wide



- » Opening angle up to 150° depending on situation
- » Adjustable closing speed and closing pressure
- » Continuously adjustable final snap for a perfect closing
- » For left & right turning gates

ITEM #	DESCRIPTION
HASAM1	Hydraulic Gate Closer

Kant-Slam

MADE IN THE
USA

Gate Closer

Closes Gates Up to 150 LBS

*Meets Self-Closing Swimming
Pool Enclosure Requirement*



- » Self-contained unit to protect gate or door from strain or pressure
- » Installs on side, top, middle or bottom of right or left-hand gate or door
- » Can be used for indoor or outdoor gates
- » Adjusting top screw regulates closing speed
- » Holds gate open when wanted

ITEM #	DESCRIPTION
HA7	Kant Slam Gate Closer

Lockey Hydraulic Gate Closer

Black Powder-Coated



Closes Gates Up to 125 LBS

Dimensions: 7 1/2" L x 13" W
2 1/2" D

NOTE: To retain product warranty & restrict gate opening angle, a gate stop must be installed.



- » Designed to push gate closed with adjustable hydraulic speed control
- » Can be installed on top, bottom or middle of gate
- » Works best on gates with in-line/flush hinges
- » Gate Material: Vinyl, Wood, Steel, Chain Link

ITEM #	DESCRIPTION
HA7TW	Hydraulic Gate Closer

Walk Gate Closer

Black Powder-Coated

*Gate Capacity:
Up to 125 LBS and 54" Wide*

NOTE: To retain product warranty & restrict gate opening angle, a gate stop must be installed.



- » Flush mount closer
- » Adjustable closing & latching speed
- » Hold open feature
- » Installs on top, middle or bottom of either right or left hand of gate
- » Mounts on opening side of gate, pushing it closed
- » Will work with most in-line hinge arrangements
- » For metal, wood or vinyl gates / doors

ITEM #	DESCRIPTION
HAD200	Walk Gate Closer

Weldable Gate Spring Closer

- » Size 9 in., 12 in., 13 in.
- » All steel construction



Black
Finish

ITEM #	SIZE	DESCRIPTION
HA9S	9"	Gate Spring
HA12S	12"	Gate Spring
HA13	13"	Gate Spring

Standard Pneumatic Door Closer



Mounting Hardware Included

ITEM #	DESCRIPTION
HADC	Pneumatic Door Closer

Standard Duty Door Closer **dormakaba**



Mounting Hardware
Included

- » For interior or exterior doors
- » Statuary bronze finish
- » Up to 100 lb. door capacity

ITEM #	DESCRIPTION
KW962	Standard Duty Door Closer

Heavy-Duty Forged Lashing Ring



Ideal for Securing Large Cargo Loads

2.5" Wide Base
1" Ring Thickness

- » Base does not come with mounting holes and requires welding to surface
- » Working load limit of 9,000 lbs

ITEM #	DESCRIPTION
HAP870	Forged Ring

Stainless Tie-Down Ring with Bracket



3.26" Length
3/8" Ring Thickness

- » Simple bolt-on mounting requires two bolts and basic hardware
- » Can also be welded to surface without mounting bolts
- » Stainless steel
- » Working load limit 1,700 lb.

ITEM #	DESCRIPTION
HAP864S	Tie Down Ring w/Bracket

Forged Lashing Ring



3.27" H
.53" Ring Thickness
Zinc-Plated Steel

- » Bolt-on mounting requires two bolts and basic hardware
- » Square holes to accept carriage bolts
- » Working Load Limit of 4,000 lbs

ITEM #	DESCRIPTION
HAP866ZN	Zinc-Plated Forged Ring

Dee Ring Handle



- » Steel, Zinc-plated
- » .140" thick wire holder

ITEM #	DESCRIPTION
HA701	Dee Ring Handle

Spring-Loaded Chest Handle



2.45" W X 5.19" L

Zinc-Plated Steel

- » Two slotted holes for mounting
- » Handle has spring-loaded bail to keep handle against chest
- » Back rubber hand grip

ITEM #	DESCRIPTION
HAP2902	Forged Ring

Medium Recessed Handle

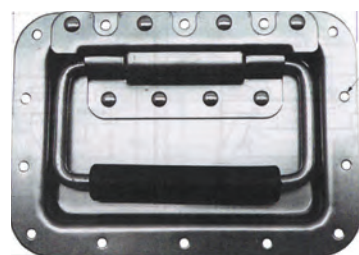

Zinc-Plated

- » .063" CRS
- » .313" dia. wire
- » Black rubber grip
- » Spring loaded
- » .625" deep

ITEM #	DESCRIPTION
HA700	Medium Recessed Handle

Wire Door Holder with 4.00" Arm



4" Length
3/16" Thick

- » Constructed of stamped steel bases and drawn steel arms
- » Parts include female receiver/keeper

ITEM #	DESCRIPTION
HAP601	Wire Door Holder w/Arm

Weldable Hasp



1.86" L
1.13" W
.060 thick

Steel Construction with Mill Finish

ITEM #	DESCRIPTION
HAP2884	Weldable Hasp

Staple for Hasp



Weldable
Mill Finish

.406" HOLE
3/4" BASE

ITEM #	DESCRIPTION
HAP2883	Weldable Staple for Hasp

Safety Chest Hasp

All Steel Construction

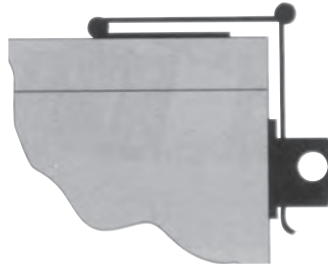

- » "Around-the-corner" installations
- » Size, Length of Slotted Part: 4-1/2"
- » Length of Hinge: 2-1/2"
- » Length of Pad: 2"
- » Width of Joint: 1-1/2"

ITEM #	DESCRIPTION
HA25	Safety Chest Hasp

Extra-Heavy Safety Hasp



- » All steel construction
- » Dimensions: 7-1/4" Straight bar

ITEM #	DESCRIPTION
HA26	Extra-Heavy Safety Hasp

Stainless Bolt-On Staple for Hasp

1.5" W x 1.5" L BASE
.613" HOLE



- » Made of 300 stainless steel

ITEM #	DESCRIPTION
HAP274SS	Stainless Staple for Hasp

Hasp with Swivel Staple

1.5" W x 4.31" L
.45" HOLE



- » Staples are designed to accommodate up to a 3/8" padlock

ITEM #	DESCRIPTION
HAP2965Z	Hasp with Swivel Staple

Small Slide Bolt

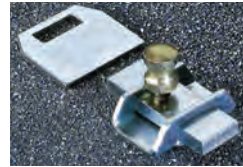

- » Weldable
- » Plated finish
- » 3/4" x 1-1/4" x 1/4" thick slide
- » Includes 1-9/16" x 1-3/4" weldable latch plate

ITEM #	DESCRIPTION
HAC673	Small Slide Bolt

Hidden Shackle Padlock/Hasp

Keyable 6-pin cylinder



- » 2-7/8" dia. x 1-1/2" thick lock
- » 3/8" dia. hidden shackle
- » 3-3/4" x 4-1/2" zinc plated hasp

ITEM #	DESCRIPTION
MA800	Hidden Shackle Padlock

Weldable Gate & Door Catch

Use with Strike Plate HAC650

7/16" thick latch & 1-1/2" x 1-1/2"

- » Weldable base
- » Weldable spring-loaded catch
- » 3/4" finger hole & solid



ITEM #	DESCRIPTION
HAC640	Large Size Weldable Catch

Strike Plate for Catch

Use with Catch HAC640

- » Weldable, heavy duty



ITEM #	DESCRIPTION
HAC650	Large: 1-1/2" x 2-5/8"

Stainless Steel Discus Lock *Master Lock*

- » Available keyed alike - specify when ordering
- » Ideal protection against bolt cutters
- » Key retaining feature ensures padlock is not left unlocked



ITEM #	SIZE
MA40	2-3/4" Wide Case

Heavy-Duty Uni-Latch *Spring-Loaded Slide Bolt*

Can be Mounted Horizontal or Vertical

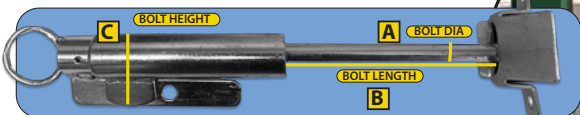

BOLT TRAVEL: 3" B = BOLT LENGTH: 5-1/4"
 A = BOLT DIA: 1/2" C = HEIGHT: 2-1/4"



ITEM #	DESCRIPTION
HAU101	Uni-Latch w/Spring Loaded Slide Bolt

Flush Slam Latch

Die Cast Zinc Bolt

2"W X 2-1/2" L
 1"LATCH



- » Sleek styling with recessed handle and concealed mounting holes
- » Zinc-plated parts provide extra corrosion resistance

ITEM #	DESCRIPTION
HAP1194	Slam Latch with Zinc Bolt

Zinc Spring-Loaded Bolt Latch

Spring Loaded Bolt

8.5" LENGTH
 3.31" LATCH

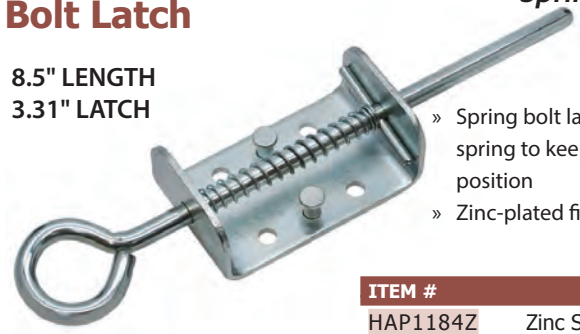

- » Spring bolt latch uses compressed spring to keep bolt in locked position
- » Zinc-plated finish over steel

ITEM #	DESCRIPTION
HAP1184Z	Zinc Spring-loaded Bolt Latch

Spring-Loaded Bolt Latch

- » Uses compressed spring to keep bolt in locked position
- » Zinc-plated finish over steel



2.85" LENGTH
 .85" LATCH

ITEM #	DESCRIPTION
HAP115903	Spring-loaded Bolt Latch

Aluminum Spring-Loaded Bolt Latch

- » Latch has PVC dipped bolt grip
- » Spring bolt latch uses compressed spring to keep bolt in locked position 4.82" LENGTH (with latch)
- » Aluminum 1.5" LATCH



ITEM #	DESCRIPTION
HAP1181A	Aluminum Latch w/Spring-loaded Bolt

Heavy-Duty Spring-Loaded Bolt Latch with Keeper

Spring Pull



- » Compressed spring keeps the bolt in locked position
- » Zinc-plated steel

5" Overall Length
 1" of BOLT Travel
 0.75" DIA

ITEM #	DESCRIPTION
HAP1260Z	Bolt Latch w/Keeper

Weld-on Slam Latch

Great for Heavy-Duty Applications Such as Cattle Carriers or Trash Enclosure Gates

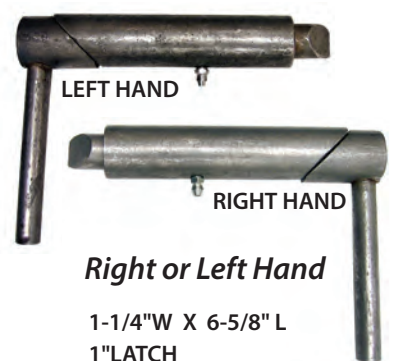

Right or Left Hand

1-1/4"W X 6-5/8" L
 1"LATCH

- » Latches are made from mill finished steel

ITEM #	DESCRIPTION
HAP1186R	Right Hand Slam Latch
HAP1186L	Left Hand Slam Latch

Zinc Spring-Loaded Bolt Latch

Spring Loaded Bolt

- » Bullet nose 6" LENGTH
- » PVC dipped bolt grip 1.25" LATCH
- » Uses compressed spring to keep bolt in locked position
- » Zinc-plated finish over steel



ITEM #	DESCRIPTION
HAP118203	Latch w/Spring-loaded Bolt

Steel Slide Bolt

Heavy-Duty



PAINTED BLACK

6" Wide
5" Height
5/8" Bolt Dia.

ITEM #	DESCRIPTION
HA8	Heavy Duty Slide Bolt

Steel Slide Bolt

Extra Heavy-Duty

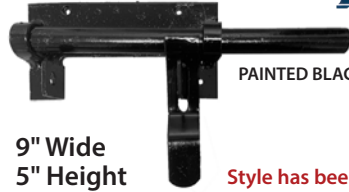

PAINTED BLACK

9" Wide
5" Height
3/4" Bolt Dia.

Style has been Updated

ITEM #	DESCRIPTION
HA106	Extra Heavy Duty Slide Bolt

Steel Slide Bolt

MEGA Heavy-Duty



PAINTED BLACK

13-1/4" Wide
8-1/2" Height
1" Bolt Dia.

ITEM #	DESCRIPTION
HA10	MEGA Heavy Duty Slide Bolt

Fancy Gate Latch



Mill Finish

- » Rugged weldable steel with mounting bracket

ITEM #	DESCRIPTION
HA57	Fancy Gate Latch

Steel Slide Bolt



Heavy-Duty



Mill Finish

- » 5-3/4" X 4" overall size
- » 1/2" Bolt

ITEM #	DESCRIPTION
HA1	Heavy Slide Bolt

Weldable Light Duty Slide Bolt



Black Powder-Coated Finish

- » 7" x 2-7/8" overall size / 3/8" Bolt

ITEM #	DESCRIPTION
HA6	Light Duty Slide Bolt

Steel Barrel Bolt Latch

Heavy-Duty

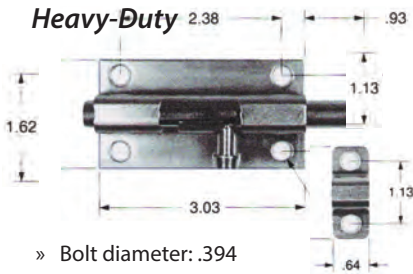

- » Bolt diameter: .394
- » Thickness: .071

ZINC PLATED

ITEM #	DESCRIPTION
HA704	Heavy Duty Barrel Bolt Latch

Gravity Gate Latch

Choose from Three Options (Listed Below)



Weldable
Self-latching

ITEM #	DESCRIPTION
HA4WHPC	Black Powder-Coated Steel with Mounting Holes
HA4	Steel with NO Mounting Holes
HA4WH	Zinc-Plated with Mounting Holes

Cylindrical Weldable Slide Bolt

- » 1/2" round bolt
- » Weldable all steel construction
- » Can be used on vertical or horizontal applications



ITEM #	LENGTH
HAC737150	6"

Locking Flush Mount Latches

- » Electro-galvanized
- » Zinc bolts
- » Stainless steel springs
- » Suggested hole 2.75" x 3.81"



ITEM #	DESCRIPTION
HA23	Locking Flush Mount Latch
HA24	Non-Locking Flush Mount Latch

Standard Gate Handle - 6"



- » Black Powder-Coated



ITEM #	DESCRIPTION
HAJ200	6" Standard Gate Handle

Heavy Duty Weldable Slide Bolt

- » 9-3/4" Length
- » 3/4" Wide bolt
- » 2" Throw
- » Zinc Finish



ITEM #	DESCRIPTION
HAC745	

POWDER-COATED LATCHES

BLACKSMITH BRAND



Bolt-On Fork Latches

For Use on Metal

3 Styles



Each Style is:

- » Gloss black powder-coated steel
- » Forked latch
- » Bolt-on for an easy install



HA81
Fits 1-1/2" Frame



HA82
Fits 2" Frame **Bolts to Frame**



Top View
of HA83, HA84, HA85

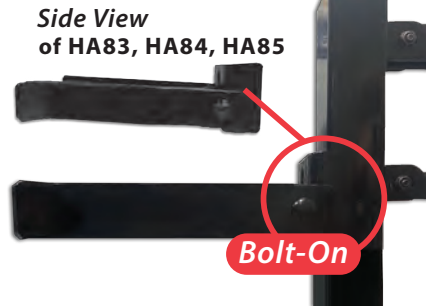

Side View
of HA83, HA84, HA85

Bolt-On

HA83, HA84, HA85 (shown above)
Bolts to Any Size Frame

Contempo Post Latch

For Use on Wood



Includes Handle

- » Black Powder-Coated

ITEM #	DESCRIPTION
HAJ250	Contempo Post Latch

Gravity Latch HD with Cable



- » Black Powder-Coated



For Use on Wood or Metal

ITEM #	DESCRIPTION
HAJ220	Gravity Latch w/Floating Bar

See Additional Self-Latching Gravity Latch on Adjacent Page

Gravity Latch Floating Bar

- » Black Powder-Coated



For Use on Wood or Metal

ITEM #	DESCRIPTION
HAJ210	Gravity Latch w/Floating Bar

Standard Post Latch



- » Black Powder-Coated
- Includes Handle

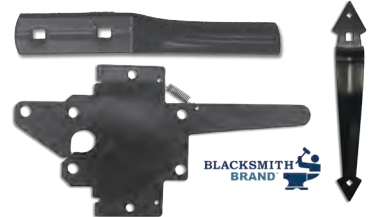

For Use on Wood

ITEM #	DESCRIPTION
HAJ230	Standard Post Latch

Ornamental Thumb Latch Kit



- » Black Powder-Coated
- Includes Handle



For Use on Wood

ITEM #	DESCRIPTION
HAJ240	Black Powder-Coated Latch Kit

Dumpster Gate Latch

- » Black Powder-Coated



For Use on Wood or Metal

ITEM #	DESCRIPTION
HA109	Dumpster Gate Latch

Adjustable Gate Frame

For Gates from 3' X 3' to 6' X 6'

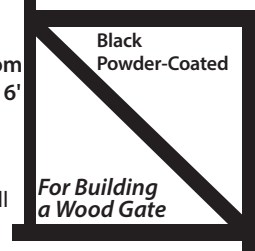

Black Powder-Coated

For Building a Wood Gate

- » Includes all Hardware

ITEM #	DESCRIPTION
HAJ65	Adjustable Gate Frame



LOCINOX® The Fortima Magnetic Child-Safe Gate Latch

**Strongest Magnetic Force on the Market:
Magnetic Distance of 1-1/4"
(2x Industry Standard!)**

- » Patented design with anodized aluminum housing
- » Tested up to 2 million cycles - Limited Lifetime Warranty
- » Rekeyable to match any lock: Schlage-C Key-in-knob cylinder (5pin, drilled 6pin)
- » Full vertical adjustability and 1" horizontal adjustability, for a gap of 3/8" up to 1-3/8"
- » Sag-proof! 3/4" vertical tolerance after installation
- » Push down prevention: only opens when magnet is pulled up

For Metal, Wood, and Vinyl Gates
Designed for Left & Right Single Leaf Gates
Fits Square Posts

ITEM #	DESCRIPTION
LKFORTIMA	Top Pull



Install the Fortima at Least 54" Above the Ground to Form a Physical Barrier that Restricts Access by Children Under 5 Years of Age



The combination of the child-safe latch **FORTIMA**, the **CARACAL GATE CLOSER** and the **SERVAL SELF-CLOSING HINGE**, assures a closed gate at all times and offers a solution for both public and private pools.

LokkLatch® Gravity Latches *Adjusts Vertically & Horizontally Vinyl & Stainless Steel Components*

LokkLatch® Optional External Access Kit Allows Main Latch to Function Outside of the Fence (HA9M4)

ITEM #	COLOR	DESCRIPTION
HA9M3	Black	LokkLatch Only
HA9M4	Black	Latch w/Access Kit

- » Strong & 100% rust proof
- » No need for padlocks
- » Fits all gate materials



LokkLatch® Pro-SL

Operates and Locks from Both Sides of Gate

- » Fully adjustable
- » **Fits posts up to 6" wide**
- » Self-Locking; Requires key to enter/exit
- » Re-keyable, 6-pin security locks
- » 100% rust proof



ITEM#	COLOR	DESCRIPTION
HAMLLP1S	Black	For Metal or Wood
HAMLLP2S	Black	For Vinyl

Tru-Close Polymer Gate Handle

Designed to fit all types of gates
For left and right opening gates

ITEM #	DESCRIPTION
HIGHMLLH	Polymer Gate Handle



LokkLatch® Deluxe

Locks and Opens from Both Sides of Gate

- » Re-keyable, 6-pin security locks
 - » 100% rust proof
 - » Fully adjustable
 - » One model fits all square posts and gate frames
 - » **Fits posts up to 6" deep**
- Suited for: Metal /Wood and Vinyl



ITEM #	COLOR	DESCRIPTION
HAMLLDAB	Black	For Metal/Wood/Vinyl



Magna-Latch® Safety Latches FEATURES

- » Magnetic latching
- » Key lockable
- » Vertical or horizontal adjustment

MagnaLatch® Top Pull Magnetic Safety Gate Latch

- » The ultimate pool safety gate latch
- » Designed especially for swimming pool gates but can be installed on any gate where child safety is important

This Model Does Not Have Alarm and Flashing LED



Available in 2 Sizes

ITEM #	COLOR	DESCRIPTION
HA9M1	Black	20-1/2" Top Pull
HA9M2	Black	10-1/4" Top Pull
HAMLKEY		Spare Key

LokkLatch Magnetic



Operates and Locks from Both Sides of Gate

Patented Push/Pull Action Magnetic Self-Latching System

- » Vertical & horizontal adjustment
- » No visible fasteners
- » Fits 1-1/2" - 6" square posts
- » Dual 6-pin re-keyable locks
- » ADA Compliant

Suited for: Metal /Wood and Vinyl

ITEM #	DESCRIPTION
HALLMBT	Magnetic Latching System

ALERT Models with NEW SAFETY FEATURES

Audible Alarm

Flashing LED



AUDIBLE ALARM
For When You Do Not Have Visual Contact



FLASHING LED
Provides a Clear Visual Warning

MagnaLatch® ALERT Top Pull Safety Latch

Pool & Child Safety

- » Visual and audible alarm
- » At-a-glance lock indicator
- » Magnetic latching
- » Includes battery, hardware, keys, manual



ITEM #	DESCRIPTION
HA9MAT1	Top Pull

Side Pull Magnetic Safety Gate Latch



Latch has No Visual or Audible Alarm

ITEM #	COLOR	DESCRIPTION
HAMLSP	Black	2-3/8" Side Pull

MagnaLatch® ALERT Vertical Pull Safety Latch

Child & Pet Security

- » Smaller, compact model
- » Visual & audible alarm
- » At-a-glance lock indicator
- » Magnetic latching
- » Includes keys, battery, hardware, manual



Both of the ALERT Latches (HAMLSP and HA9MAT2) Includes Flashing LED & an Audible Alarm

Flashing LED

Audible Alarm



ITEM #	DESCRIPTION
HA9MAT2	Vertical Pull



Two
Sizes
24"
and
36"

Mild Steel Drop Rod with Wood Brackets

Black
Powder-Coated
Steel
Wood Brackets



» 5/8" diameter
bolt

ITEM #	DESCRIPTION
HAJ350	24" w/ Wood Brackets
HAJ300	36" w/ Wood Brackets

Premium Grade Heavy-Duty Steel Cane Bolt



Decorative
Ball Handle



- » Premium, heavy-duty welded steel construction
- » Unpainted steel finish

1/2" Diameter
Square Bolt

ITEM #	LENGTH
HA14	16"

Steel Cane Bolt

Extra Heavy-Duty



- » 20" length (measurement does not include extension)
- » 3/4" diameter bolt
- » Heavy-duty welded construction

ITEM #	LENGTH
HAGH12320	20"

Mechanical Locking Cane Bolt



22" Length

- » 1/2" diameter bolt
- » Mill Finish
- » Can be used with standard padlock



ITEM #	LENGTH
HA19CB	22"

Q-Bolt™ Cane Bolts

Stainless Steel Construction

- » 9/16" diameter bolt
- » Made from high grade stainless steel, polished then powder-coated
- » Padlockable

ITEM #	LENGTH
HAQB124	24"
HAQB140	40"

Economy Cane Bolts

- » Plated round bar
- » For wood or metal fences



ITEM #	SIZE	LENGTH
HA12	1/2"	12"
HA18	1/2"	18"
HA24CB	5/8"	24"

Lokk Bolt Lockable Cane Bolt

An Optional Base Plate
Offers Added Strength To
The Securing Ground Hole

- » 3/4" diameter bolt
- » Ideal for double drive gates
- » Key-lockable and re-keyable

ITEM #	DESCRIPTION
HALB124BXKS	24" L Cane Bolt
HALBBPBG	Base Plate

Steel Extra Thin Double Style

- » 16 gauge
- » Two 2-1/8" Holes
- » 7-1/2"H x 4-3/8"W
- » 1" Depth / 2-3/8" Backset
- » Design fits flush on 1" frame
- » Crimped slam guard
- » 20 pieces per box



ITEM #	DESCRIPTION
LB218DT	Extra Thin Double Lockbox

Steel Extra Thin Single Style

- » 14 gauge
- » 2-1/8" Hole
- » 4-1/4" H x 4-1/2"W
- » 1" Depth
- » Design fits flush on 1" frame
- » 2-3/8" backset
- » 40 pieces per box

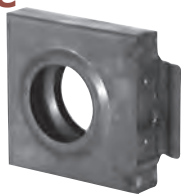

ITEM #	DESCRIPTION
LB218T	Extra Thin Single Lockbox

Steel Standard Double Style

- » 14 gauge
- » Two 2 1/8" Holes
- » 6-3/4"H x 4-1/4" W
- » 1-5/16" Depth
- » 2-3/8" backset
- » 20 pieces per box



ITEM #	DESCRIPTION
LB218D	Standard Double Lockbox

Steel Standard Single Style

- » 14 gauge
- » 2-1/8" Hole
- » 4-1/4"H
- » 3-1/2" W
- » 1-5/16" Depth
- » 2-3/8" backset
- » 40 pieces per box



ITEM #	DESCRIPTION
LB218	Standard Single Lockbox

Steel Extra Wide Double Style

- » 14 gauge
- » Two 2-1/8" Holes
- » 6-3/4" H
- » 4-1/4" W
- » 1-1/2" Depth
- » 2-3/8" backset
- » 20 pieces per box



ITEM #	DESCRIPTION
LB218DXW	Extra Wide Double Lockbox

Steel Extra Wide Single Style

- » 14 gauge
- » Single 2-1/8" Hole
- » 4-1/4" H
- » 3-1/2" W
- » 1-1/2" Depth
- » 2-3/8" backset
- » 40 pcs per box



ITEM #	DESCRIPTION
LB218XW	Extra Wide Single Lockbox

Steel 2-3/4" Backset Single Style

- » 16 gauge
- » 2-1/8" hole
- » 3-5/16" H
- » 4-5/16" W with 1" gate stop extension
- » 1-1/2" Depth
- » 2-3/4" backset
- » 40 pcs per box



ITEM #	DESCRIPTION
LB218234	Commercial Single Lockbox

Mortise Lock Box

- » 14 gauge
- » Height 7-1/4" H x 4" W
- » 1" Depth
- » Available in right or left hand operation



ITEM #	DESCRIPTION
LB9200L	Left Handed Mortise Lockbox
LB9200R	Right Handed Mortise Lockbox

Lockbox for SlimLine Locks

- » 14 gauge
- » 84" height, can be trimmed to 79-1/4"
- » Pre-punched
- » 2" x 1" tube
- » Fits Slim-Line Mortise Lockset Item# MCLH123



ITEM #
LB123

Aluminum Single Style

- » 16 gauge
- » 2-1/8" hole
- » 4-1/4" W
- » 4-1/4" H
- » 1-1/2" Depth
- » 2-3/8" backset

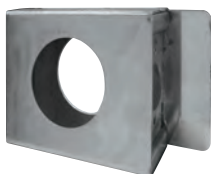

ITEM #	DESCRIPTION
LBAC218T	Alum. Single Style

Aluminum Double Style

- » 16 gauge
- » 2-1/8" hole
- » 4-1/4" W
- » 6-3/4" H
- » 1-1/2" Depth
- » 2-3/8" backset



ITEM #	DESCRIPTION
LBAC218DT	Alum. Double Style

SmartKey deadbolts and locks have passed the most stringent lock picking standard, UL 437, par. 11.6 and are available in all ANSI Grades.

Kwikset FINISHES

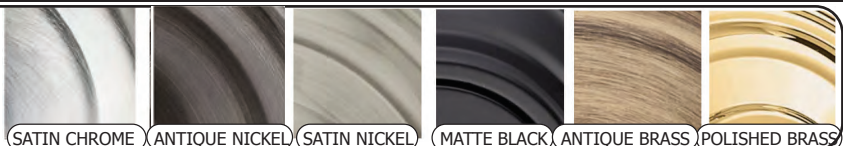

SATIN CHROME

ANTIQUE NICKEL

SATIN NICKEL

MATTE BLACK

ANTIQUE BRASS

POLISHED BRASS



The Halifax Double Cylinder Deadbolt 2 Finishes

Matte Black Shown Here



Deadbolt Latch has Round Corner Faceplate

- » 2 keys included
- » Keyed on both sides
- » ANSI/BHMA grade 2 certified
- » 1-inch round deadbolt throw
- » Adjustable backset 2-3/8" to 2-3/4"
- » Microban Antimicrobial product protection keeps door hardware 99.9% cleaner than unprotected surfaces

Works with the Following Lock Boxes:
LB218, LB218D, LB218XW, LB218DXW

Will Not Work with 1" Lock Boxes

Kwikset

SmartKey Security™ re-key technology, is compatible with Kwikset (KW1) keyway or (SC1) keyway

Easily Installs in Minutes with Just a Screwdriver



Satin Nickel Shown Here



ITEM #	DESCRIPTION
KW159514	Matte Black
KW15915	Satin Nickel

Economy Standard Duty Double Cylinder Deadbolt 2 Finishes

Full 1" Bolt

Features Concealed Mounting Screws

- » Keyed on both sides
- » Kwikset keyway
- » Standard 2-3/8" backset
- » Up to 12 keyed alike



ITEM #	DESCRIPTION
MCLBL19	Polished Brass Deadbolt
MCLBL20	Antique Brass Deadbolt

Kwikset Series 980 Deadbolts

Matte Black Finish

- » Adjustable latch
- » Full 1" bolt



SMART KEY

ITEM #	DESCRIPTION
KW980514	Single Cylinder Deadbolt
KW985514	Double Cylinder Deadbolt

Standard Duty Double Cylinder Deadbolt 6 Finishes



Satin Nickel Shown Here



- SmartKey Security™ re-key technology, is compatible with Kwikset (KW1) keyway or (SC1) keyway
- » 2 keys included; Keyed on both sides
 - » ANSI/BHMA grade 3 certified
 - » 1-inch deadbolt throw
 - » Adjustable deadbolt to fit all standard door preparations

ITEM #	DESCRIPTION
KW665514	NEW FINISH: Matte Black
KW6653	Polished Brass
KW6655A	Antique Brass
KW66526D	Satin Chrome
KW66515	NEW FINISH: Satin Nickel
KW66515A	Antique Nickel

Heavy-Duty Double Cylinder Deadbolt 2 Finishes



Satin Chrome Shown Here

Antique Nickel Shown Here

SMART KEY SmartKey Security™ re-key technology, is compatible with Kwikset (KW1) keyway or (SC1) keyway

- » Adjustable Backset 2-3/8" or 2-3/4"
- » Keyed on both sides
- » Full 1" bolt
- » Adjustable deadbolt and latch

ITEM #	DESCRIPTION
KW78526	Satin Chrome
KW78515	Antique Nickel

Standard Duty Single Cylinder Deadbolt 3 Finishes



Antique Brass Shown Here

- » Keyed on one side
- » Full 1" bolt
- » Thumb turn on one side
- » Adjustable deadbolt
- » Up to 6 keyed alike
- » 2-3/8" Backset

ITEM #	DESCRIPTION
KW6603	Polished Brass
KW6605A	Antique Brass
KW66015	Antique Nickel

Cove Passage Knob

Non-Locking

Kwikset

- » Universal handing (KW1) keyway or (SC1) keyway options
- » Fits both right and left handed doors
- » ANSI/BHM grade 3 certified
- » Adjustable backset 2-3/8" to 2-3/4"



ITEM #	DESCRIPTION
KW200C514	Matte Black
KW200C15	Satin Nickel

Polo Passage Knob

Non-locking

Kwikset

- » Plain knob on both sides
- » Turning either knob retracts latch
- » All steel latch.



ITEM #	DESCRIPTION
KW200P5A	Antique Brass
KW200P15	Antique Nickel

Hancock® Passage Knob

Matte Black Finish

Kwikset

- » Non-locking
- » Adjustable latch



ITEM #	DESCRIPTION
KW720H514	Passage Door Knob

The Halifax Lever Passage / Non-Locking

Kwikset

2 Finishes



Works with the Following Lock Boxes:

LB218, LB218D, LB218XW, LB218DXW

ITEM #	DESCRIPTION
KW720HF	Matte Black
KW720H15	Satin Nickel

- » Used on passage doors requiring **no locking functionality**
- » Latch has round corner faceplate
- » Meets ADA/ANSI A117.1 requirements
- » ANSI/BHMA grade 2 certified
- » Adjustable backset 2-3/8" to 2-3/4" to fit all standard door preparations

Easily Installs in Minutes with Just a Screwdriver

Lido Lever Handle

Polished Brass

Kwikset

3 Finishes



- » Non-locking
- » Turning either lever retracts latch

ITEM #	DESCRIPTION
KW200L3	Polished Brass
KW200L5A	Antique Brass
KW200L15	Antique Nickel

The Breton Lever Passage / Non-Locking

Kwikset

2 Finishes



Works with All Lock Boxes

ITEM #	DESCRIPTION
KW200B514	Matte Black
KW200B15	Satin Nickel

- » Latch has 3 interchangeable faceplates: round corner, square corner, drive-in collar
- » NSI/BHMA grade 3 certified
- » Latch has adjustable backset 2-3/8" to 2-3/4" to fit all standard doors
- » Meets or exceeds Underwriter Laboratories (UL) testing requirements specified for each product grade or rating

Easily Installs in Minutes with Just a Screwdriver

Delta Lever Handle

Kwikset 3 Finishes

Satin Chrome

- » Non-locking
- » Reversible
- » Turning either lever retracts latch

ITEM #	DESCRIPTION
KW200D3	Polished Brass
KW200D26D	Satin Chrome

Tylo Entry Lockset

- » Available keyed alike
- » Keyed on one side, thumb turn on the other
- » Up to 6 keyed alike



ITEM #	DESCRIPTION
KW400T3	Polished Brass
KW400T5	Antique Brass

Tylo Passage Knob

- » Non-locking
- » Plain knob on both sides
- » Turning either knob retracts latch
- » All steel latch



ITEM #	DESCRIPTION
KW200T3	Polished Brass
KW200T5A	Antique Brass
KW200T26D	Satin Chrome

Commonwealth® Passage Lever

Matte Black Finish

Kwikset

- » Reversible lever
- » Non-locking
- » Adjustable latch
- » Fits right and left handed doors

ITEM #	DESCRIPTION
KW720C514	Passage Leverset

NOTE
The Interior Knobs on this Page are Available by Special Order Only with Very Short Lead Times.

Light Commercial Keyed Storeroom Lockset

Lever or Knob

- » Can be used with electric strike hardware
- » Outside unlocked only while key is turned
- » Inside always free
- » MCLXL14S32D - 2-3/8" with 2-3/4" backset
- » KW462KN26D is 2-3/4" backset

ITEM #	DESCRIPTION
MCLXL14S32D	Knob Storeroom Lockset
KW462KN26D	Lever Storeroom Lockset

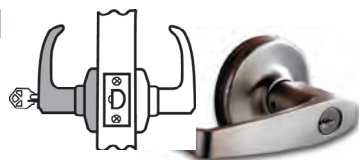

These Locksets Work with All Strikes on this Page



Satin Chrome Finish

Deadlocking Gate Latches

Kwikset These Locksets Work with All Strikes on this Page

- » Single cylinder (key/thumb turn)
- » Double cylinder (key/key)
- » Fits standard 2-1/8" hole lock box
- » Used w/ electric strike hardware

ITEM #	FINISH	DESCRIPTION
KW5883	Polished Brass	Single Cylinder
KW5893	Polished Brass	Double Cylinder
KW58926D	Brushed Chrome	Double Cylinder



ANSI Type Commercial Electric Strike

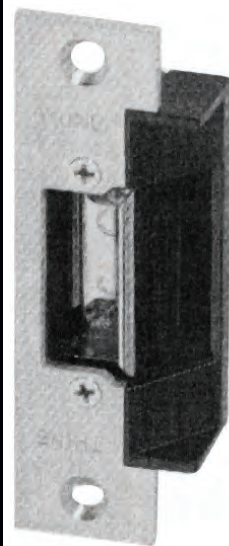

- » 4-7/8" faceplate with 3-3/8" aux ramp
- » Fail secure
- » 16-24 AC/DC
- » For use on commercial doors

ITEM #	DESCRIPTION
ER2012	ANSI Type Strike

Residential Electric Strikes



Can be used in conjunction with Kwikset Deadlocking Gate Latches KW5883, KW5893, KW589326D.

Style A:

- » 1-3/8" wide
- » 3-1/2" tall
- » 2-3/4" deep
- » Fail secure



Weldable Lockbox

Style B:

- » 8-16 Volt
- » 1-1/4" wide
- » 5-7/8" tall
- » 1-9/16" deep
- » Fail secure



ITEM #	DESCRIPTION
ER005	Style A Electric Strike
ER001	Style B Electric Strike
LBES	Weldable Lockbox for A

Mortise Type Commercial Electric Strike



- » Mortise type 6-7/8" radius corner face plate
- » Fail secure
- » 16-24 AC/DC
- » Use on commercial doors

ITEM #	DESCRIPTION
ER2678	Mortise Type Strike

Outdoor Rated Electric Strike

Stainless Steel



- » Faceplate: 1-1/4" x 4-7/8"
- » Fail secure/safe field reversible
- » 1,000,000 life cycles
- » Cavity dimensions: 7/8" D 1-1/2" H 3/4" W
- » Mortise type backset 11/16" D

ITEM #	DESCRIPTION
ER400	Right Hand Outdoor Strike
ER400L	Left Hand Outdoor Strike

Double Cylinder Ornamental Iron Mortise Lockset

Polished
Brass
Finish



- » Full 1" bolt
- » Easily reversible
- » Kwikset keyway
- » Reversible - right or left hand
- » Use optional lockbox item #LB9200

ITEM #	DESCRIPTION
MCLGMW23AC	Dbl. Cyl. Mortise Lockset

Slim-Line Mortise Lockset 5/8" Deadbolt

Polished
Brass
Finish



Fits
Lockbox
Item #
LB123

- » 1/2" Latch
- » Kwikset keyway
- » Double solid brass rekeyable cylinders
- » Solid brass decorative lever with trim
- » Reversible

ITEM #	DESCRIPTION
MCLH123	Slim Lockset

Hook Lock with Weldable Steel Box



- » Key on both sides
- » Ideal for sliding and double doors
- » Includes black painted weldable steel lock box
- » Kwikset Keyway
- » 1-7/8" W x 7-1/8" H x 1-3/4" Depth

ITEM #	DESCRIPTION
MCLHL100	

Door Lock Installation Kit



- » Fits 2-3/8" backset
- » 3/8" mandrel for hole saws
- » GuideRight® template for hole alignment
- » 2-1/8" bi-metal hole saw for door face bore
- » 1" bi-metal hole saw for door edge bore



ITEM #	DESCRIPTION
PA17104	Installation Kit

Keyless Lever Window Guard Emergency Release

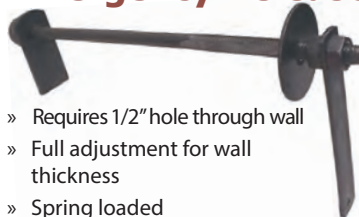

- » Requires 1/2" hole through wall
- » Full adjustment for wall thickness
- » Spring loaded

ITEM #	SIZE	DESCRIPTION
MCLEM200	11"	Emergency Release

"Speed Latch" Keyless Release

- » Does not require drilling through wall
- » Quick and easy operations
- » For inside mount guard
- » Fast installation



ITEM #	DESCRIPTION
MCLEM300L	Left Operation
MCLEM300R	Right Operation

Keyless Push-Button Release

- » Easy, quick installation
- » Push button release inside
- » 11" rod through wall; only one 5/16" bore through wall
- » 2-1/2" between guard & frame
- » Weatherproof/Tamperproof
- » No assembly required on lock mechanism

For exterior mounted window guards only

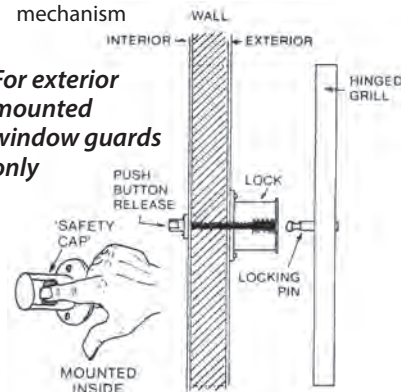

ITEM #	DESCRIPTION
MCLEM100	Push Button Release



Deadlocking Latch with Double Sided Keypad

6- 5/16" H
2-3/4" W
1-3/16" Depth

Fits 1-1/2" to 2-1/2" Gate Frames

Works on Left or Right Hand Doors

**Bolt-On
Black Powder-Coated
Double-Sided**

- » Adjustable dead latch for different width gate frames
- » No welding required
- » Powder coated black



ITEM #	GATE FRAME SIZE	DESCRIPTION
MCLBDG4060	1-1/2" to 2-1/2"	Double-Sided Keypad Lock

Deadlocking Latch with Single Sided Keypad Left or Right Hand Available

Fits 1-1/2" to 2-1/2" Gate Frames

6- 5/16" H 2-3/4" W 1-3/16" Depth

Black Powder-Coated

No Welding Required

- » Single sided digital keypad
- » Left handed or Right handed available
- » Adjustable dead latch for different width gate frames



R.H. Lock

L.H. Lock

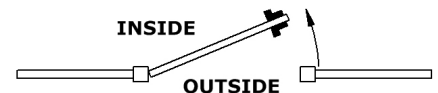

ITEM #	HAND	DESCRIPTION
MCLBDGS4060R	RIGHT Hand	Single-Sided Keypad Lock
MCLBDGS4060L	LEFT Hand	Single-Sided Keypad Lock

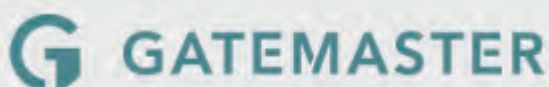

Bolt-On Deadlock & Latch

Fits 1-1/2" to 2-1/2" Gate Frames

No Additional Hole Required!

Deadbolt Combined With Same Latch Cylinder

Works on Left or Right Hand Doors

Black Powder-Coated

- » Adjustable dead latch for different width gate frames
- » No welding required
- » Powder coated black

ITEM #	GATE FRAME SIZE
MCLBLD40605	1-1/2" to 2-1/2"



6- 5/16" H
2-3/4" W
1-3/16" Depth



Bolt-On Secure Keeper for All GateMaster Locks

Slim keep that fits between the gate and the post for use with the Superlock range of locks

No Welding Required Black Powder-Coated

Mount the gate slam plate onto the gate frame when fixing the lock and use the expanding fasteners to fix the keep onto the gate post

- » Secure – Prevents access to the latchbolt
- » Improves gate appearance – Slim design improves gate appearance
- » Versatile – Gate keep is simple and easy to fit to a wide range of applications

ITEM #	DESCRIPTION
MCLBSK	Black Keeper for All GateMaster Locks



Works for All
GATEMASTER
Locks

EE1000 Series Double-Sided Keypad Entry

Satin
Chrome
Finish



- » With knobs (field reversible)
- » 5/8" throw latch
- » 2-3/4" backset



ITEM #	DESCRIPTION
MCLU1011EE	Double-Sided Mech.

Weldable Lockbox for MCLU1011EE

ITEM #
LB1000EE



Simplex Mechanical Entry Lever for Exit Device

Fixed
ADA-Compliant
Lever

Satin Chrome
Finish

- » 1/2" throw latch
- » 2-3/4" backset
- » Heavy-duty cast front housing
- » Heavy-duty mounting plate
- » Door width; 1-3/8" to 2-3/4"
- » Vandal resistant



ITEM #	DESCRIPTION
MCLULP1010L	Left Hand Handle
MCLULP1010R	Right Hand Handle

Works with this Heavy-Duty Exit
Pushbar (Item # GTMF18RBAL)

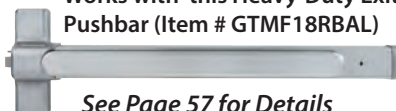

See Page 57 for Details

L1000 Series Single-Sided Keypad Lever Entry

Satin
Chrome
Finish



- » Single access code
- » Programmable without removing lock
- » 5/8" throw latch
- » 2-3/4" backset



L1000 Door Handing

Lock is not field reversible.

- » You must specify the handing of your door for the L1000 Series Single Sided Keypad Lever Entry.
- » Look at the door in its closed position from the exterior (push button side), and use the corresponding diagram.

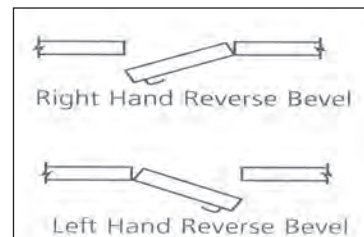
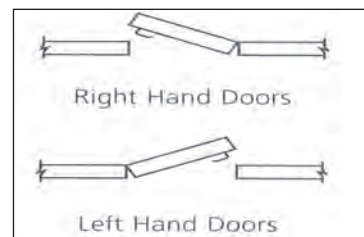

ITEM #	DESCRIPTION
MCLU1011L	Left Hand Handle
MCLU1011R	Right Hand Handle

900 Series Single-Sided Keypad Entry

Satin
Chrome
Finish



- » Single access code
- » Programmable without removing lock
- » Field reversible latch
- » Latch hold back
- » Lock option - 1" throw deadbolt
- » Lock option - 5/8" throw latch



ITEM #	DESCRIPTION
MCLU900	Single-Sided Mech.

Weldable Lockbox for 900 Series

ITEM #
LB900



1000 Series Single-Sided Keypad Entry

Satin
Chrome
Finish



- » With knobs (field reversible)
- » 5/8" throw latch
- » 2-3/4" backset



ITEM #	DESCRIPTION
MCLU1011	Single-Sided Mech.

Weldable Lockbox for MCLU1011

ITEM #
LB1000



Weldable Lockbox for L1000 Series

ITEM #
LB1000



Mechanical Deadbolt Code Lock

Satin Chrome Finish

- » Free-spinning stainless steel core shaft that cannot be cut with a hacksaw
- » Right or left hand door, changeable
- » Single or double combination available
- » Adjustable deadbolt length
- » Easy code change as often as required
- » Different or same codes on each side of double sided units
- » Covers 2-1/8" hole



ITEM #	DESCRIPTION
MCLL2210	Single Sided Deadbolt Knob
MCLL2210DS	Double Sided Deadbolt Knob

ITEM #	DESCRIPTION
LB2835	Weldable Lockbox for Lockey Locks

Mechanical Latch Code Lock

Satin Chrome Finish

- » Changeable combination
- » For right or left hand door handing
- » 2-3/8" or 2-3/4" deadlocking spring latch
- » Easy code change as often as required
- » Weather Resistant



ITEM #	DESCRIPTION
MCLL2835	Single-Sided Latch Silver
MCLL2835BK	Single-Sided Latch Black
MCLL2835DS	Double-Sided Latch Silver
MCLL2835DSBK	Double-Sided Latch Black
MCLL238	Replacement Strike

ITEM #	DESCRIPTION
LB2835	Weldable Lockbox for Lockey Locks

Add-A-Bolt Gate Kit



- » Length: 6"
- » Width: 2"
- » Depth: 1-1/2"

GB210 Gate Kit includes:

- » GB-Add-A-Bolt Gate Box
- » M210DC Keyless Deadbolt
- » Drive-in Deadbolt
- » Bolts to Existing Gate Frame

Highly recommended to drill hole 15/16" & file to fit. A sloppy bolt will not seat properly.

ITEM #	DESCRIPTION
MCLLAAB	Add-A-Bolt Gate Kit

GB210 Plus-L Kit

- » Steel Gate Box w/ Lever and Keyless Deadbolt
- » 4-3/4" W
9-3/4" H
1-3/4" D
- » Double sided
- » Satin Chrome Finish



ITEM #	DESCRIPTION
MCLLGB210L	Knob and Lever Kit

Weldable Steel Lockbox

For Lockey and Code Locks Brands

- » 4-3/4" W x 7-5/8" H x 1-3/4" Depth
- » 2-3/8" backset
- » 1-7/16" x 1-3/4" square hole for mechanicals, 7/16" hole at top



ITEM #	DESCRIPTION
LB2835	Lockbox for Lockey & Code Locks

2950 Hook Bolt

- » Replaces Adams-Rite Lock
- » Mortised hook bolt lock; 1-1/8" backset
- » Five-ply laminated steel hook bolt with concealed hardneed steel pin for maximum security



INSIDE



Outside



DOUBLE

Lockbox Sold Separately

ITEM #	COLOR
MCLL2950	Satin Chrome
MCLL2950DC	Double Satin Chrome
MCLL2950BK	Black
MCLL2950DCBK	Double Black
MCLLGB950	Lockbox for 2950 Hook Bolt

NOTE

The Locks on this Page are Available by Special Order Only with Very Short Lead Times.

Maglock with or without Integrated Pull/Push Handles LOCINOX®



WITH HANDLES

WITHOUT HANDLES



Eliminate Welding

Fast, Easy and a Nicely Finished Mounting Using Quick-Fix Bolts and Drilling Five Holes
BOLTS ON PAGE 56

- » Guaranteed holding force tested on every magnetic lock
- » Anti-residual magnetism kick-off system
- » Fail open

Surface Mounted
Raised Edge on the Magnet Housing
Makes It Impossible to Put a Crowbar
Between the Magnet and the
Armature Plate

Designed for Exterior Use

- » Weatherproof Aluminum Housing
- » Two-layer protective coating developed for outdoor use
- » 500h salt spray resistant SGS Certified (ISO 9227)

Voltage: 12V / 24V DC

Minimal Pulling Force: (1300 lbs)

Current: 460 mA / 12 V or 230 mA / 24 V

ITEM #	HANDLES
GTMAG9005	With Handles
GTMAGMAG9005	Without Handles



Swing Gate Lock LOCINOX®

US Mortise Cylinder Keyway

Interchangeable with All Locinox Locks

Designed Specifically For 1-1/8" Mortise Profile Cylinder, which is Considered Standard and Commonly Used on Doors /Gates Across the USA



(Includes Handle)

Key-operated Self-Latching Bolt; Allows Free Exit Application

Aluminum Housing with Stainless Steel Mechanism

Cylinder is a Schlage™ keyway

The Lock Box Requires a 3-3/8" Spacing to the First Picket, Fitting Nicely Into Most Gates

- » Fixing cylinder inch thread 8/32"
- » Easy left or right changing of self-latching day bolt
- » Throw of the dead bolt, 7/8" in one turn of the key



Double Cylinder Dead Bolt

- » Adjustment of the bolts up to 3/8" continuous without removing the lock
- » Comes standard with 5pin keyed alike or keyed different (drilled 6pin)
- » 4-hole mounting w/two hex head socket screws
- » ISO 9227 KTL / E-coated lock box withstands 1000 hours of salt spray test

ITEM #	COLOR
LKLUKY4040	Black

Ornamental Swing Gate Lock

LOCINOX®



Handle Included

- » Cast aluminum lockbox
- » Stainless steel internal components; 2-piece stainless steel latch & deadbolt
- » Latch bolt/deadbolt externally adjusted
- » Left & right hand reversible from outside the lockbox
- » Throw length 1"

Width: 3-1/8" with Black Finish

ITEM #	GATE FRAME SIZE	COLOR
LKLAPY10FBL	3/8" to 3/4"	Black
LKLAKY20FBL	1"	Black
LKLAKY30FBL	1-1/4"	Black
LKLAKY40FBL	1-1/2"	Black
LKLAKY50FBL	2"	Black

Industrial Swing Gate Locks

Left & Right Hand Reversible



Handle Included

- » Throw length 1" LOCINOX®
- » Stainless steel internal components
- » Cast aluminum lockbox, lock body width 3-1/2"
- » Stainless steel latch bolt & deadbolt

Silver Finish

ITEM #	GATE FRAME SIZE	COLOR
LKLAKQ30USL	1-1/4"	Silver
LKLAKQ40USL	1-1/2" to 2"	Silver

Black Finish

ITEM #	GATE FRAME SIZE	COLOR
LKLAKQ30UBL	1-1/4"	Black
LKLAKQ40UBL	1-1/2" to 2"	Black

Mechanical Code Lock for Swing Gates



- » Stainless steel internal components
- » 100% mechanical: no battery or electricity needed
- » Able to set different entrance /exit codes
- » Polyamide rain and dust cover

Black Finish

ITEM #	GATE FRAME SIZE	COLOR
LKLMKQ30VBL	1-1/4"	Black
LKLMKQ40VBL	1-1/2" to 2"	Black

Silver Finish

ITEM #	GATE FRAME SIZE	COLOR
LKLMKQ30VSL	1-1/4"	Silver

Security Keeper

LOCINOX®

Prevents Opening Gate with a Crowbar
Adjustable for Profiles

1-1/2" to 2-1/2"

- » Reinforced stainless steel
- » Round and square profiles
- » Stainless anchoring system
- » Stainless adjustable slam plate with shock rubber
- » Left or right hand

ITEM #	LATCH POST SIZE	COLOR
LKSHKLQFBL	1-1/2" - 2-1/2"	Black
LKSHKLQFAL	1-1/2" - 2-1/2"	Alum.



Free Exit / Mechanical Code Lock

LOCINOX®



- » Entrance secured by code, free exit
- » Easy and fast set-up or modification of the access codes
- » Automatic code reset after opening after pushing the handle
- » Anti-code detection with integrated security press plate
- » Gate capacity of up to 220 lbs

ITEM # GATE FRAME PROFILE/COLOR

LKLFKQ30XBL	1-1/4"	Sq.	Blk
LKLFKQ40XBL	1-1/2" to 2"	Sq.	Blk

Keeper for Square Tubing

Adjustable for Profiles 1-1/2" to 2-1/2"

For Square Profile Post and Gate Frames

- » Stainless steel w/ Polyamide finishing
- » Aluminum stop plate w/ rubber strip
- » Left or right hand changing
- » Includes Quick-Fix mounting bolts

ITEM #	GATE FRAME SIZE	COLOR
LKSAKLQFBL	1-1/2" - 2-1/2"	Black
LKSAKLQFAL	1-1/2" & Larger	Alum.



Sliding Gate Lock

LOCINOX®

- » Now with gate lock and 2" stainless steel catch bolts
- » Stainless steel internal components
 - » Cast aluminum lockbox
 - » Lock body W: 3-1/2"

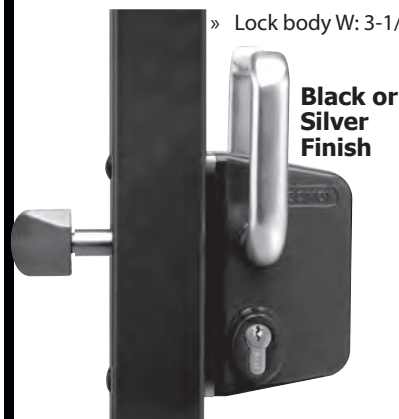

Enclosure (LKOSET) & Catch (LKSSKZ) Sold Separately

ITEM #	COLOR
LKLSKZ50UBL	Black
LKLSKZ50USL	Silver

Stainless Steel Catch

Catch is 2-1/2" W

ITEM #	DESCRIPTION
LKSSKZ	Catch For Square Tube Posts



Replacement Stainless Steel Catch Bolt

ITEM #	GATE FRAME	MATERIAL
LK701540	1-1/2"	Stainless
LK701550	2"	Stainless
LK701580	3"	Stainless
LK7015100	4"	Stainless



Adapter Plates for Round Tubing

LOCINOX®

Adaptor Plate for Security Keeper

ITEM #
LK6403



Adaptor Plate for Standard Keeper

ITEM #
LK3018LA



Adaptor Plate for Gate Lock

ITEM #
LK3019LA



NOTE
The Locks on this Page are Available by Special Order Only with Very Short Lead Times.

NOTE

The Products on this Page are Available by Special Order Only with Very Short Lead Times.

Drilling Jig For Surface Mounted Locks and Corresponding Keeps **LOCINOX**



Includes Tool Box

- » Tool case with self-centering drilling tool for fast assembly of Locinox surface mounted gate locks and keeps
- » Drill jig can be used for round, square or rectangular profiles from 30 up to 76mm (1-1/4" up to 3")
- » Includes 3 drill bits (Ø9,5 mm, Ø15 mm, Ø18 mm)
- » Includes LA Locitool
- » Includes Allen Key and positioning pin

Useful for installation of Locinox bolt-on locks and keeps



4 Easy Steps



ITEM #	DESCRIPTION
LKDRILLFIX	Drilling Jig w/Tool Case

Electric Strike **LOCINOX** Updated Version - Now Fail / Open

- » Type SE.E: Emissa - Fail secure
- » Type SE.R: Ruptura - Fail open (Fail Safe)
- » Pressure resistance on self-latching bolt: 1000 lbs
- » Reinforced stainless steel deadbolt receiver
- » Water resistant, weatherproof; use outdoors or indoors
- » Stainless steel latching
- » Voltage: 12 V AC/DC



ITEM #	DESCRIPTION
LKSEE	For Profiles 2" & Larger

Chain Link Tension Bar Adapter **LOCINOX**

- » Secures chainlink fence around industrial locks
- » Hot-dip galvanized
- » Install with 2 tension bands
- » Secures around Locinox industrial, electrical, garden, and sliding gate locks
- » Ties in with the tension bar for a finished look

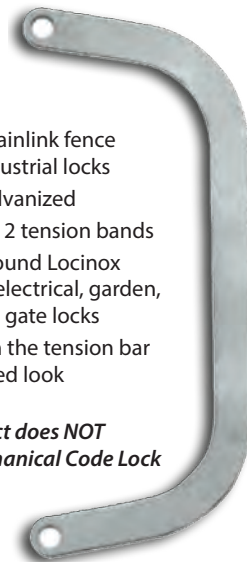

This product does NOT fit the Mechanical Code Lock

ITEM #	DESCRIPTION
LKCLH	Tension Bar Adaptor

Quick-Fix Mounting Bolts **LOCINOX**

- » For square posts - 1-1/2" minimum
- » Mounts with "molly bolt" type fasteners
- » Fast, easy alternative to through bolts

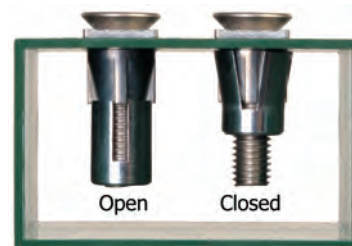

Sold in Pairs

ITEM #	DESCRIPTION
LKQF2	Quick-Fix Mounting Bolt

Surface Mounted Installation Kit

- Kit Includes**
- » Keeper
 - » Tube mount
 - » Gate stop

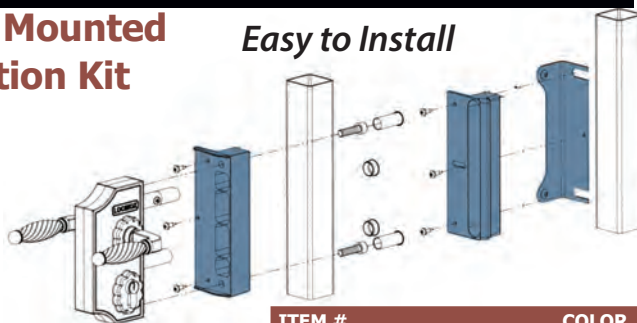

Easy to Install

ITEM #	COLOR
LKIKIT60BL	Black

Push Bar Exit Device Strike



- » Use with panic bars; up to 1" throw
- » Automatic voltage sensing
11 to 28 volts DC
- » Satin stainless steel finish
- » Fail secure/fail safe: field reversible
- » Holding Force: 3,000+ lbs

ITEM #	DESCRIPTION
ER4800	Push Bar Exit Strike

Exit Control Hardware



ECL-230D Series

- » Non-handed, for left or right doors
- » Powered by one 9 volt battery
- » When armed, pressing exit bar retracts deadbolt & sounds alarm to allow exit
- » Rugged housing with key lock and saw-resistant bol
- » Corrosion resistant
- » Rim cylinders - **cylinders NOT included**

ITEM #	DESCRIPTION
GTDECL230DPH	Exit Device
GTA4032	Rim Cylinder with Key



Commercial Heavy-Duty Exit Device



- » Door Thickness – 1-3/4" std.
- » 36" door size, field sizeable to 32" door
- » Stile Width - 4-1/4" Minimum
- » Heavy duty, architectural grade and exceed ANSI Gr. 1

- » Non-handed, for left or right
- » Latchbolt – stainless steel 3/4"
- » **Rim cylinder is not included**

ITEM #	DESCRIPTION
GTMF18RBAL	Heavy Duty Pushbar
GTA1301	Door Pull/Rim Cylinder Housing
GTA4032	Rim Cylinder with Keys



Commercial Standard Duty Pushbar

- » Non-handed, for left or right
- » Field sizeable: 36" device to 32"
- » Door Thickness – 1-3/4" standard
- » Latchbolt - 1/2" throw top; 3/8" bottom

- » Door pull width - 3-7/8" (98mm)
- » **Rim cylinder is not included**



ITEM #	DESCRIPTION
GTM19RBA	Standard Duty Pushbar
GTA1955	Door Pull/Rim Cylinder Housing
GTA4032	Rim Cylinder with Keys

Aluminum Pushbar



- » Anodised black, aluminium pushbar with stainless steel mechanism
- » Pressing the pushbar operates the deadbolt
- » Easy to install on the gate with Locinox Quick-Fix Bolts (Page 56)
- » Delivered with blinded 5/16" follower
- » Pushbar length is standard (3.773 ft) and may be shortened
- » Dummy cylinder recommended



Ideal with the Free Exit Lock Found on Page 55

Free Exit Lock and Pushbar Sold Separately

Maximum Width: 4.429 FT

ITEM #	DESCRIPTION
LKPB1	Push-to-Exit Bar

Easily Convert Gates into Panic Exits where Free Egress is Necessary

Safety Kit Pre-Drilled

- » Easily convert gates into secure panic exits with free egress
 - » No delay in exiting
 - » Edge shield moves bar closer to strike
 - » Keyed access from outside of gate
- Kit Includes One of Each:**
- » Key box
 - » Keyed cylinder
 - » Strike bracket (silver)
 - » 24" Lockey panic shield (silver)
 - » 33" Lockey grade 1 panic bar (silver)

ITEM #	DESCRIPTION	FINISH
MCLLPSSAF	Safety Kit	Silver



Security Kit MAX-Guard Cover Plate Provides Extra Security Pre-Drilled

- » Easily convert gates into secure panic exits with free egress
 - » No delay in exiting
- Kit Includes One of Each:**
- » Strike Bracket (Silver)
 - » Keyless Lock
 - » 24" Lockey Panic Shield (Silver)
 - » 33" Lockey Grade 1 Panic Bar (Silver)
 - » Lockbox (gate box)
 - » MAX-Guard cover plate

ITEM #	DESCRIPTION	FINISH
MCLLPSSSEC	Security Kit w/MAX-Guard Cover Plate	Silver



Safety Kit with DETEX Shield and Bar Pre-Drilled

- » Easily convert gates into secure panic exits with free egress
 - » No delay in exiting
 - » Kit provides everything needed for your gate security
- Kit Includes One of Each:**
- » Key box
 - » Keyed cylinder
 - » Strike bracket (black)
 - » 24" DETEX Panic shield (black)
 - » 36" DETEX V-40 Grade 1 panic bar (black)

ITEM #	DESCRIPTION	FINISH
MCLLPSSK	Safety Kit with DETEX Shield / Bar	Black



Simplex Mechanical Entry Lever for Exit Device Compatible with Above Panic Shields

- » Fixed ADA-Compliant lever
- » 1/2" throw latch
- » 2-3/4" backset
- » Heavy-duty cast front housing
- » Heavy-duty mounting plate
- » Door width; 1-3/8" to 2-3/4"
- » Vandal resistant

Easy Programming -
A single access-code is programmed using keypad and without removing lock from door

ITEM #	DESCRIPTION
MCLULP1010L	Left Hand Handle
MCLULP1010R	Right Hand Handle





Heavy-Duty Casters

Two Sizes Available:
4" x 2" or 6" x 2"

Three Styles

- » Polyurethane Molded on Cast Iron
- » Roller bearing in wheel
- » Zinc plated for corrosion resistance
- » Double ball raceway with 5/8" Kingbolt
- » Grease fittings on raceways and axles
- » 4" x 4-1/2" Top plate



ITEM #	WHEEL DIA.	LOAD CAP.	TOP PLATE	OVERALL HEIGHT
HA4PR	4"	800 lbs.	Rigid	5-5/8"
HA6PR	6"	1200 lbs.	Rigid	7-1/2"

ITEM #	WHEEL DIA.	LOAD CAP.	TOP PLATE	OVERALL HEIGHT
HA4PS	4"	800 lbs.	Swivel	5-5/8"
HA6PS	6"	1200 lbs.	Swivel	7-1/2"

ITEM #	WHEEL DIA.	LOAD CAP.	TOP PLATE	OVERALL HEIGHT
HA4PSB	4"	800 lbs.	Swivel w/Brake	5-5/8"
HA6PSB	6"	1200 lbs.	Swivel w/Brake	7-1/2"

Semi-Steel Casters with Roller Bearing

Two Sizes Available:
4" x 2" or 6" x 2"

Two Styles



- » Swivel caster with cast steel wheel
- » Straight roller bearing in wheel
- » 4" x 4-1/2" Top plate
- » 2-5/8" x 3-5/8" -to- 3" x 3" Bolt hole pattern
- » 3/8" Mounting bolt
- » Zerk fitting on wheel



ITEM #	WHEEL DIA.	LOAD CAP.	TOP PLATE	OVERALL HEIGHT
HA4SRH	4"	700 lbs.	Rigid	5-5/8"
HA6SRH	6"	1200 lbs.	Rigid	7-1/2"

ITEM #	WHEEL DIA.	LOAD CAP.	TOP PLATE	OVERALL HEIGHT
HA4SS	4"	700 lbs.	Swivel	5-5/8"
HA6SS	6"	1200 lbs.	Swivel	7-1/2"

Fully-Pneumatic Wheel Casters

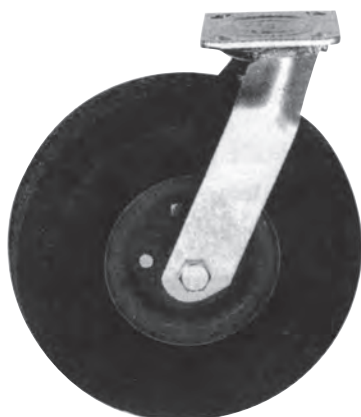

- » Wheel size: 8" x 2-1/2"
- » Plate size: 4-1/2" x 4" x-1/4"

ITEM #	STYLE
HA27	Swivel
HA29	Rigid

Multi-Purpose Casters

- » Driveway Gates
- » Moving Dolly
- » Tool Carts
- » Equipment Racks
- » Portable Conveyors



ITEM #	WHEEL DIA.	LOAD CAP.	WHEEL MTL.	TOP PLATE
HA2SM	2"	125 lbs.	Metal	Swivel
HA3SM	3"	250 lbs.	Metal	Swivel
HA4SM	4"	350 lbs.	Metal	Swivel
HA212SR	2 1/2"	175 lbs.	Rubber	Swivel
HA3SR	3"	210 lbs.	Rubber	Swivel
HA4SR	4"	300 lbs.	Rubber	Swivel
HA6SR	6"	560 lbs.	Rubber	Swivel
HA2RM	2"	125 lbs.	Metal	Rigid
HA3RM	3"	250 lbs.	Metal	Rigid
HA4RM	4"	350 lbs.	Metal	Rigid
HA212RR	2 1/2"	175 lbs.	Rubber	Rigid
HA3RR	3"	210 lbs.	Rubber	Rigid
HA4RR	4"	300 lbs.	Rubber	Rigid
HA6RR	6"	560 lbs.	Rubber	Rigid



Premium 5-1/2" Steel V-Groove Wheels

- » Double sealed bearings
- » 1-3/4" width
- » 5/8" bolt and nut included
- » Plated finish

Recommended for use with Steel V-Groove Track HAC293

ITEM #	DESCRIPTION
HAC305V140	5-1/2" V-Groove Wheel

Premium 4" Steel V-Groove Wheels

- » Double sealed bearings
- » 1-3/8" width
- » 9/16" bolt and nut included
- » Plated finish



Recommended for use with Steel V-Groove Track HAC293

ITEM #	DESCRIPTION
HAC305V100	4" V-Groove Wheel

Box For Premium 4" Steel V-Groove Wheels (HAC305V100)

- » Weldable
- » 4-3/8" x 3" x 1-1/2" heavy gauge steel



ITEM #	DESCRIPTION
HAC100	Box For HAC305V100



Light Duty 2" Steel V-Groove Wheels

- » 3/8" bolt and nut included
- » Plated finish

Recommended for use with Steel V-Groove Track HAC293

ITEM #	DESCRIPTION
HAC300D50	2" V-Groove Wheel

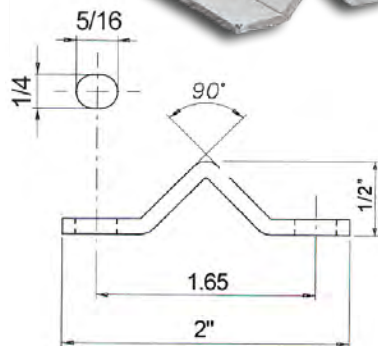

- » 2" width low profile, 236" long
- » 1/8" thickness
- » Hole spacing is 18" on center
- » Galvanized finish

ITEM #	DESCRIPTION
HAC293	Steel V-Groove Track



4" Steel V-Groove Wheels

- » With mounting bracket
- » Heavy duty double sealed bearings
- » Mounts on 1" or wider tube frame
- » Plated finish

Recommended for use with Steel V-Groove Track HAC293

ITEM #	DESCRIPTION
HAC326V100	4" V-Groove Wheel

4" Steel V-Groove Wheels



- » With mounting plates
- » Double sealed bearing construction
- » Weldable plates allow for easy insertion into 2" wide tube frame
- » 1" wide wheel
- » 2" total frame width

Recommended for use with Steel V-Groove Track HAC293

ITEM #	DESCRIPTION
HAC333D100	4" V-Groove Wheel



Boxes For V-Groove Wheels

All steel construction
for easy welding

- » 4" box: 2-1/4" W x 5-1/4" L x 3" Tall
- » 6" box: 2-3/4" W x 7" L x 4-1/8" Tall

Note: 6" box only fits 6"
Cast Iron Wheel

ITEM #	DESCRIPTION
HA21B	4" Wheel Box
HA22B	6" Wheel Box

Steel "V" Groove Wheels

A Superior, Maintenance-Free Wheel in 4 or 6 Inch



- » All steel construction
- » 4" dia. x 1-3/4" wide; 3000 lbs. capacity
- » 6" dia. x 1-3/4" wide; 6000 lbs. capacity
- » Sealed bearings (no grease fittings)
- » 4" model includes 1/2" bolt and nut
- » 6" model includes 1/2" bolt and nut
- » Gold/zinc plating
- » Maintenance free

Recommended for use with V-Groove
Track HA21TR4



Recommended for use with
V-Groove Track HA21TR4
(See Below)

ITEM #	DESCRIPTION
HA40	4" V-Groove Wheel
HA41	6" V-Groove Wheel

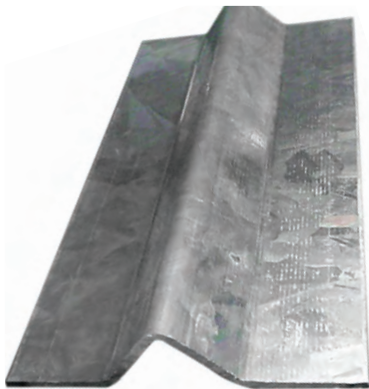

Slide Gate "V" Groove Track

- » Fits V-groove wheels
on this page
- » .905" H x 4" W x 20 ft L
- » 12 ga. galvanized steel

ITEM #	DESCRIPTION
HA21TR4	V-Groove Track

Cast Iron Standard "V" Groove Wheels

Optimal Performing Wheel

CAST IRON BODY

- » Grease fitting for easy lubrication
- » Roller bearings for easy operation
- » Rolls smoothly on ordinary angle iron
- » Complete with 1/2" mounting bolt & nut



Recommended for use with
V-Groove Track HA21TR4
(Track on Left)

ITEM #	DESCRIPTION
HA21	4" Cast Iron V-Groove Wheel
HA22	6" Cast Iron V-Groove Wheel

Premium Heavy-Duty Cantilever Gate Rollers

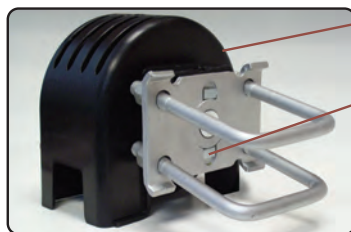

» Includes heavy-duty ABS cover to protect rollers and bearings in all weather conditions

» Quick mount magnetic base

Galvanized metal components for long lasting performance. Machined 7" dia nylon roller provides smooth operation. Also feature 1-1/8" axles and heavy-duty bearings. ABS covers can be mounted on top or bottom.



Sealed Bearings

Includes Heavy-Duty Cover Shown Above

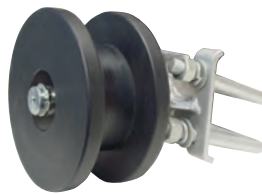

Round Nylon Gate Roller

ITEM ID	GATE FRAME OD	POST SIZE
HA55R	2-3/8" Round	3" Round
HA52	2-3/8" Round	4" Round
HA58	2-3/8" Round	6-5/8" Round

Square Nylon Gate Roller

» For 2" square gate frame and 4" square post

ITEM ID	GATE FRAME OD	POST SIZE
HA51	2" Square	4" Square

Industrial Ductile Iron Cantilever Gate Roller



Sealed Bearings

NEW! SIZE
6-3/8" Round Post

- » For 3" or 4" or 6-5/8" round O.D.
- » 6" wheel and bracket
- » Includes U-bolts

ITEM #	GATE FRAME	POST SIZE
HA32	2-3/8" OD	3" Round O.D.
HA33	2-3/8" OD	4" Round O.D.
HA33L	2-3/8" OD	6-3/8" Round O.D.

NEW! SIZE
6-3/8" Round Post

Safety Roller Cover

For Use with the Nylon Cantilever Gate Rollers (See Above)



- » Constructed of plastic materials
- » Gate roller not included

ITEM #	FOR POST SIZE
HA56C	4" Round

Cast Iron Industrial Mini Cantilever Roller



- » 2-1/2" O.D. post
- » 1-5/8" O.D. gate frame
- » Includes U-bolts for round post

ITEM #	GATE FRAME	POST SIZE
HA31	1-5/8" OD	2-1/2" Round

General Duty Steel Gate Roller



- » 5" wheel
- » For 1-5/8" O.D. pipe

ITEM #	FOR POST SIZE
HA20	1-5/8" OD Pipe

U-Bolt Sets

- » Used to mount rollers on square or round posts
- » Includes two square or two round U-bolts, washers and nuts



ITEM #	FOR POST SIZE
HA54SQ	4" Square
HA54RD	4" Round

Rubber Roller Guides

- » Rollers are permanently mounted in bracket.

ITEM #	ROLLER LENGTH	ROLLER DIA
HA34	3"	2-3/8"
HA35	6"	2-3/8"
HA36	12"	2-3/8"

Premium Roller Guides

Rollers are Removable and Replaceable

Protective Cover

Available Item # HA38

- » UV Protected Hard Plastic

ITEM #	COLOR	LENGTH
HA35XBLK	Black	6"
HA35XWHT	White	6"

6" Premium Roller Protective Cover



BLACKSMITH BRAND

Cover is constructed of heavy-duty plastic

Roller Not Included

Cover fits HA35XBLK

ITEM #	COLOR	DESCRIPTION
HA38	Black	Protective Cover Only

Flat Groove Wheel



Premium Zinc-Plated Steel

Bolt/Nut Included

ITEM #	DESCRIPTION
HAC3WCPR	3" Diameter

Roller Guides

- » Adjustable for gate frames up to 3-3/4" wide
- » Bracket Dimensions: 1-3/4" x 7-1/8" x 3-1/2"
- » Bracket Thickness: 1-4"
- » Rollers Dimensions: 1-3/16" dia x 1-1/2"
- » Bolt Holes: 3/8" x 9/16" oblong

ITEM #
HAC2120

Nylon Roller Guide

- » Small 1" dia. 2-3/4" L
- » Medium 1-1/2" dia 3" L

ITEM #	SIZE
HAC243D25	Small 1" dia. 2-3/4" L
HAC243D40	Medium 1-1/2" dia 3" L

Heavy Duty Spring Gate Casters

Rated for 1,000 lbs

- » 6" wheel
- » Compression spring helps support gate/door
- » Weldable 4" x 11" heavy duty mounting bracket constructed from 5/16" steel with 7/16" mounting holes

ITEM #	SPRING TRAVEL DISTANCE
HA16HD	1"

Gate Spring Roller

- » Height: 16-3/4"
- » Heavy Duty Spring
- » Mill finish
- » 3" Swivel Caster

ITEM #
HA16

Gate-Stop Gate Alignment Device

- » Black
- Molded from high-strength polymer materials, it is guaranteed against rust, distortion and staining. An integrated rubber buffer protects against 'gate slam' and reduces noise.

ITEM #	APPLICATION
HITCGS1	Vinyl Gates
HITCGS2	Wood/Vinyl Gates
HITCGS3	Metal Gates

Weldable Gate & Door Stop

D = 1.89"

L = 2.75"

H = 2.95"

T = 0.98"

S = 0.39"

Please see our website for technical drawing

ITEM #
HAC200G

Multi-Purpose Solid Rubber Tire

- » 8" diameter
- » 1-3/4" wide
- » 5/8" Bore

Axle not included.

ITEM #
HA37RT

Double Wheel Gate Carrier

6" Solid rubber tires

ITEM #	WHEEL SIZE
HA19	6"

Premium Quality Sliding Door Track & Roller System

Premium Quality Sliding Door Track & Roller System works with items in this section only.

Premium Galvanized Track

- » Dimensions:
1-3/4" W
2-1/8" H
236" L
- Weight: 42 lbs.

ITEM #
HAC24



Bottom Roller Guide

- » Nylon roller

ITEM #
HAC36



We offer a FREE service to cut track into smaller sections for shipping via UPS. Requested cutting for in store purchases will be charged a small cutting fee.

Two Wheel Trolley

- » Forged body
- » Steel wheels with heavy duty bearings

Sold individually

ITEM #
HAC2C



Two Wheel Turning Trolley

- » Forged body
- » Steel wheels with heavy duty bearings.

Sold individually

ITEM #
HAC8C



Four Wheel Trolley

- » Forged body
- » Steel wheels with heavy duty bearings

Sold individually

ITEM #
HAC4C



Premium Overhead Trolleys

These premium overhead trolleys work with standard sized I-beams.

3" Overhead Trolley

- » With 2-1/2" drop
- » Fits 3" or 4" I-beams
- » Trolley Center Spacing: 6" min./ 36" max.
- » Single Trolley Load Capacity: 200 lbs.

ITEM# DESCRIPTION
HATA3 3" Overhead Trolley



4" Overhead Trolley

- » With 3-3/16" drop
- » Fits 5" or 6" I-beams
- » Trolley Center Spacing: 8" min./ 32" max.
- » Single Trolley Load Capacity: 400 lbs.

ITEM# DESCRIPTION
HATA5 4" Overhead Trolley

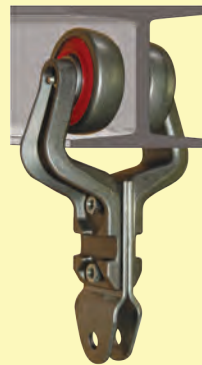

Sliding Door Track & Roller System

The Sliding Door Track & Roller System works with items in this section only.



Trolley Wheels

- » Steel bearings
 - » For sliding door track HA301
- Sold in set of two hangers.**

ITEM #
HA303W



Trolley Wheels

- » Used in conjunction with either sliding door track to the right HA301/HA30112 or HA301RP

Sold in sets of two hangers.

ITEM #	DUTY RATING
HA302	Standard Duty
HA306H	Heavy Duty

Double Track Bracket

- » For HA301 track.

ITEM #
HA301B22



Adjustable Face Mount Track

- » For HA 301 track.

ITEM #
HA301B12



Adjustable Door Guide/Stop

- » Expandable
- » For doors from 2-1/2" to 6" thick
- » Mounts sideways for use as a stop



ITEM #
HA301B50

Face Mount Sliding Door Track Bracket

- » Made from galvanized steel

ITEM #
HA301B



Stay Roller

- » Fabricated from 3/16" zinc plated steel, adjusts from 1" to 3-3/4" for range of door widths.

ITEM #
HA301B40

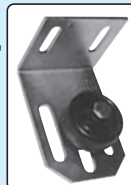

Standard Duty Galvanized Steel Sliding Door Track

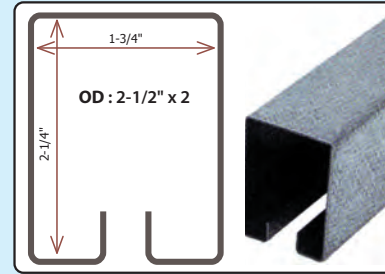

- » Galvanized steel trolley track
- » Max. capacity 400 lbs.
- » Stocked in 12' and 24' lengths

ITEM #	LENGTH
HA30112	12 feet
HA301	24 feet

Standard Duty Sliding Door Track

Red Primed Steel

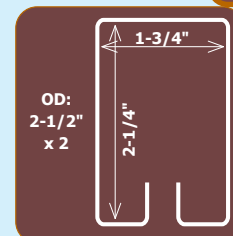

Save Money Using Red Primed Steel

ITEM # LENGTH
HA301RP 19.6 feet

Aluminum Sliding Gate Track and Hardware

Track Mounts to *SIDE* of Gate

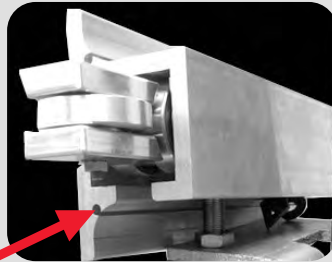
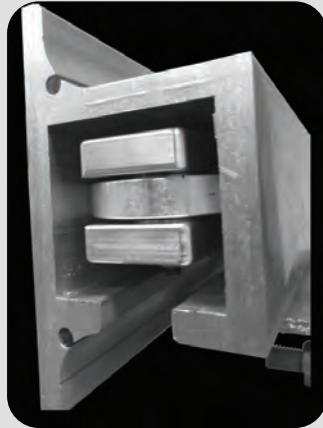

To Connect Two Tracks, Insert Spring Pin Here
Spring Pin Sold Separately

Aluminum Track

Custom Track Lengths Available -
Give Us a Call with Your Specifications

Track Sold in 20 FT* Sections or Custom Lengths

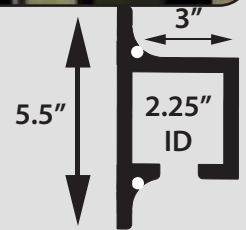

ITEM #	DESCRIPTION	LENGTH
HAD110	Aluminum Track	20 FT*

We offer a FREE service to cut track into smaller sections for shipping via UPS. Requested cutting for in store purchases will be charged a small cutting fee.

NOTE:

Two Spring Pins are Required to Connect Track. Pins are Sold Individually

Stainless Steel Slotted Spring Pin

Spring Pin Will Connect Two Aluminum Tracks (HAD110)

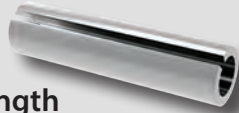

2" Length
1/4" dia

ITEM #	DESCRIPTION
HAD200PRD	Stainless Slotted Spring

Slide Gate Trolley



4 Bearings
8-Wheels

- » Stainless steel hardware
- » Steel bearings wheels
- » Sealed steel ball bearings
- » Stainless steel mounting assembly rod
- » Fits standard 2.25" x 2.25" I.D. gate track

ITEM #	DESCRIPTION
HAD100	Trolley w/ Steel Guide Roller

Guide Roller

Secures and guides the gate bottom

Photo Shown is for Round Pipe



ITEM #	DESCRIPTION
HAD150	For 4" SQUARE Post
HAD160	For 4" OD Round Pipe

U-Bracket



For mounting gate trolley to post

- » Hot dipped galvanized
- Shown Here Using HAD130

ITEM #	DESCRIPTION
HAD140	Bracket for 4-1/2" OD Round
HAD10	Bracket for 4" Square

TOP MOUNT CANTILEVER GATE SYSTEM

All Steel Top Mount Cantilever Gate System

Guide Track

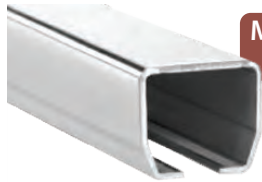

MEDIUM DUTY

Galvanized

WIDTH: 2-3/8"
THICKNESS: 1/8"

HEIGHT: 2-3/8"
LENGTH: 236"

ITEM #	DUTY
HAC345M	Medium

Bracket for Guide Track HAC345M (see above)



» Support bracket for Item # HA345M

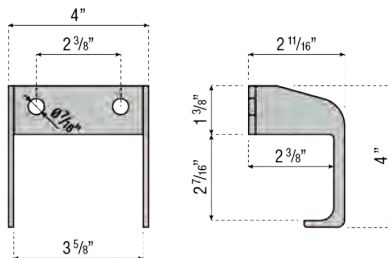

ITEM #	DESCRIPTION
HAC130621	Bracket Used w/HA345M

Guide Roller for 4" OD Round Pipe or Square Post



Photo Shown is for Round Pipe

ITEM #	DESCRIPTION	SIZE
HAD150	SQUARE- Bottom Guide Roller	4" SQ
HAD160	ROUND- Bottom Guide Roller	4" OD

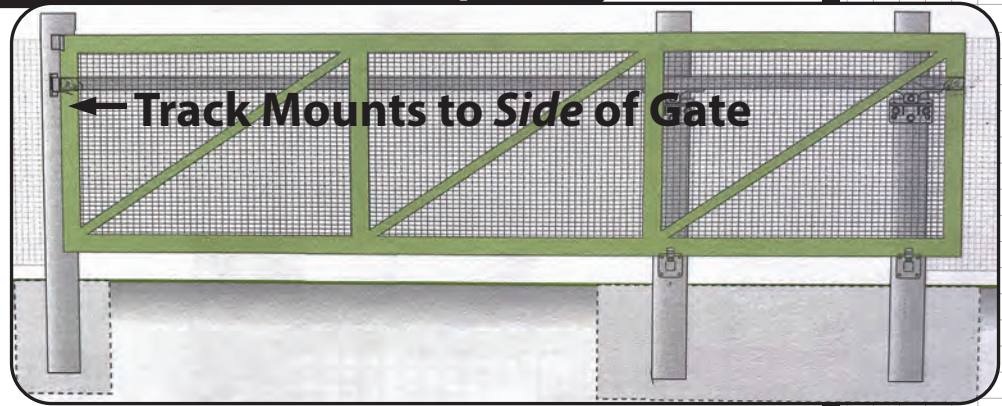

Cantilever Gate Rollers



9-WHEELS

ITEM #	DESCRIPTION
HAC3019MT	Top Mount Support Track Roller

Weight Capacity: 24 FT Gate Opening / 600LBS
Width: 3-1/16" Length: 10-5/8"

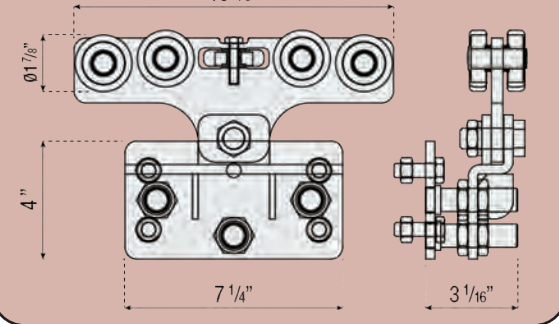

Gate Roller Bracket for Round Post



» 4" OD round bracket for gate roller

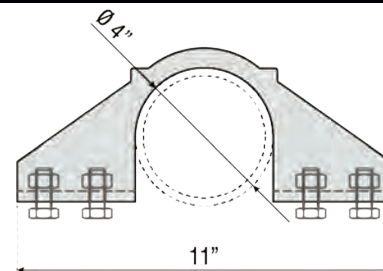

ITEM #	DESCRIPTION
HAC11201R	Top Mnt Roller for Round Post

Gate Roller Bracket for Square Post



» 4" OD square bracket for gate roller

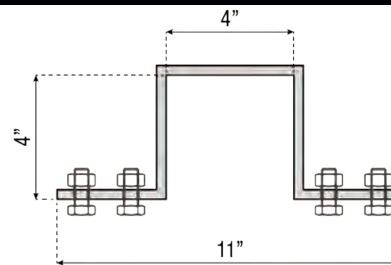

ITEM #	DESCRIPTION
HAC11241SQ	Top Mnt Roller for Square Post

Rolling Cantilever Gate System

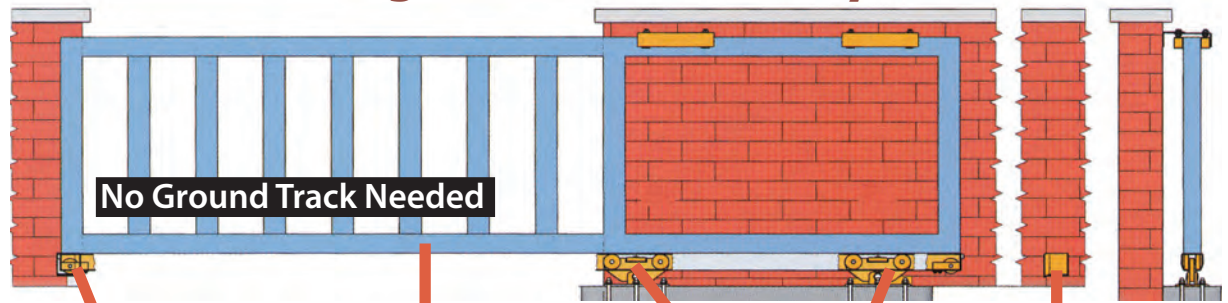

End Wheel

The End Wheel encloses the exposed end of the guide track.

It acts as a gate stop and guide, ensuring correct closing alignment and guiding the gate on to the end cap.

- » Fully sealed bearing construction

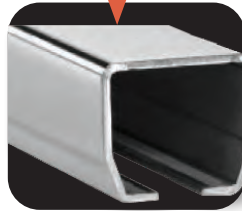

Guide Track

We offer a FREE service to cut track into smaller sections for easy shipping via UPS.

- » Galvanized track
- » Runs entire length of gate

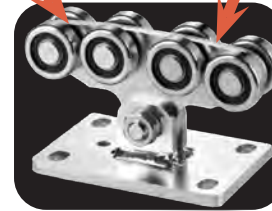

Gate Roller

- » Fully sealed bearing construction



End Cap

The End Cap fits into the Guide Track, closing the end of the channel and providing a finished look.

See the optional Post Mounting Bracket for Gate Rollers on adjacent page



How this System Works

The cantilever gate system has no ground track. Instead, the gate has a bottom rail, which uses two sets of enclosed rollers to support the gate opening/closing.

The gate rollers, both the same size, are spaced apart at a distance and anchored.

An end cap or post is placed at one end to ensure the gate cannot slide free of the mounting. For additional support, an end wheel can be installed to ensure correct alignment when closing.

This Gate System is Suited for:

- High Traffic Industrial & Commercial Properties
- Climates that Receive Ice & Snow
- Entrances on an Incline
- Entries Where the Use of Ground Track is not an Option

Advantages

- **No Disruption to the Driveway** - Great for pavers or sculptured driveways
- **Driveway Does Not have to be Flat, Level or Concrete** - Bumps or dips in the driveway, gravel or grass entrances have no impact on the opening/closing of the gate
- **Works on an Angle** - Ideal for driveways with steep inclines
- **No Track Damage** or continual track maintenance due to high traffic entrances
- **Debris Removal is Minimal** - With no track or wheels on the ground, gate opens easily and free of obstructions
- **Snow & Ice Will Not Affect Wheel Movement** - None of the wheels or track come directly or indirectly in contact with the ground
- **Easy, Quick Install** - Requires no ground track installation
- **The Gate Cannot be Lifted Off the Track** - Entrance remains secure
- **Quieter than Track Systems** - No noise from wheels moving across track

Rolling Cantilever Gate System

MEDIUM-DUTY

Guide Track



WIDTH: 2-3/8" HEIGHT: 2-3/8"
THICKNESS: 1/8" LENGTH: 236"

ITEM #	DUTY
HAC345M	Medium

Gate Rollers



WEIGHT CAPACITY: 1765 LBS EA
WIDTH: 4-3/8" HEIGHT: 4-3/4"
THICKNESS: 3/8" LENGTH: 8-1/4"

ITEM #	DUTY
HAC350M	Medium

HEAVY-DUTY

Guide Track



WIDTH: 4" HEIGHT: 3-1/2"
THICKNESS: 3/16" LENGTH: 236"

ITEM #	DUTY
HAC345P	Heavy

Gate Rollers



WEIGHT CAPACITY: 2755 LBS EA
WIDTH: 6" HEIGHT: 6-3/4"
THICKNESS: 1/2" LENGTH: 11-13/16"

ITEM #	DUTY
HAC350P	Heavy

EXTRA HEAVY-DUTY

Guide Track



WIDTH: 5-1/2" HEIGHT: 5-1/2"
THICKNESS: 1/4" LENGTH: 236"

ITEM #	DUTY
HAC345XL	Extra-Heavy

Gate Rollers



WEIGHT CAPACITY: 5300 LBS EA
WIDTH: 7-7/8" HEIGHT: 9-1/2"
THICKNESS: 5/8" LENGTH: 19-5/8"

ITEM #	DUTY
HAC350XL	Extra-Heavy

End Wheel



ITEM #	DUTY
HAC347M	Medium
HAC347P	Heavy
HAC347XL	Extra Heavy-Duty

End Cap



ITEM #	DUTY
HAC346M	Medium
HAC346P	Heavy
HAC346XL	Extra Heavy-Duty

Premium Roller Guides

ITEM #	COLOR	LENGTH
HA35XBLK	Black	6"
HA35XWHT	White	6"



See Page 63 for All Roller Guide Options

Post Mounting Bracket for Gate Roller

The Optional Post Mounting Bracket attaches the gate rollers to a 4" X 4" post

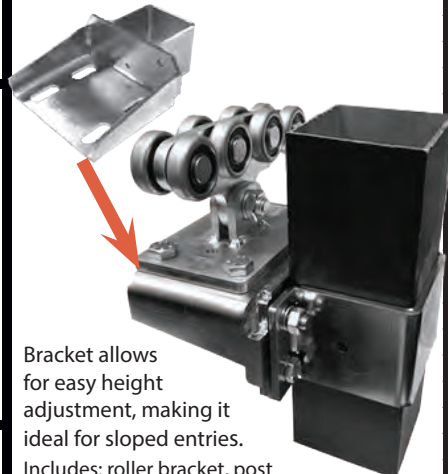

Bracket allows for easy height adjustment, making it ideal for sloped entries. Includes: roller bracket, post bracket, bolts, lock washers and nuts

ITEM #	DUTY
HAC304M102Q	Medium

STAINLESS STEEL

2 Track Lengths

4 Styles



DOUBLE WHEEL TOP MOUNT

SINGLE WHEEL TOP MOUNT



SINGLE WHEEL SURFACE MOUNT



ROUND BAR



Everything for Installation is Included with This Kit

Stainless steel track (72" or 96") with end caps
2 Hangers
Wall brackets
1 Door bottom guide
2 Track stops
Mounting and installation hardware

- » Anti-rise pin in each hanger prevents door from coming off track
- » 304 stainless steel track and hanger
- » Nylon coated rollers
- » ANSI/BHMA 156.14 (Grade 1) compliant
- » Track Lengths: 72" or 96"
- » **This Kit Uses Round Bar**

ITEM #	MOUNTING	TRACK LENGTH
HAR91410072	SINGLE WHEEL SURFACE MOUNT	72"
HAR91410096	SINGLE WHEEL SURFACE MOUNT	96"
HAR9146072	SINGLE WHEEL TOP MOUNT	72"
HAR9146096	SINGLE WHEEL TOP MOUNT	96"
HAR9147072	DOUBLE WHEEL TOP MOUNT	72"
HAR9147096	DOUBLE WHEEL TOP MOUNT	96"

Everything for Installation is Included with This Kit



BRUSHED STAINLESS STEEL FLAT MOUNT

Max Finished Opening Width: 96"
** Max Door Thickness: 1-3/4"
Max Door Weight: 225 lbs

**Installation dimensions based on cased opening without doorway trim.
Adjust measurement if there is a door jamb trim.

BRUSHED STAINLESS STEEL

- » Use with 1 or 2 sliding doors
- » Brushed Stainless Steel Finish
- » All steel components
- » Track Lengths: 79" or 103"
- » **This Kit Uses Flat Bar**

Max Finished Opening Width: 96"
** Max Door Thickness: 1-3/4"
Max Door Weight: 225 lbs

**Installation dimensions based on cased opening without doorway trim.
Adjust measurement if there is a door jamb trim.

ITEM #	FINISH	TRACK LENGTH
HAR89STS79	BRUSHED STAINLESS STEEL	79"
HAR89STS103	BRUSHED STAINLESS STEEL	103"

POWDER COATED



2 Track Lengths

3 Finishes



- » Use with 1 or 2 sliding doors
- » All finishes are powder-coated over steel
- » All steel components
- » Track Lengths: 79" or 103"
- » **This Kit Uses Flat Bar**

Max Finished Opening Width: 96"
 ** Max Door Thickness: 1-3/4"
 Max Door Weight: 225 lbs

***Installation dimensions based on cased opening without doorway trim. Adjust measurement if there is a door jamb trim.*

Everything for Installation is Included with Kits



ITEM #	FINISH	TRACK LENGTH
HAR89BK79	POWDER-COATED BLACK	79"
HAR89BK103	POWDER-COATED BLACK	103"
HAR89BRZ79	POWDER-COATED BRONZE	79"
HAR89BRZ103	POWDER-COATED BRONZE	103"
HAR89SN79	POWDER-COATED SATIN NICKEL	79"
HAR89SN103	POWDER-COATED SATIN NICKEL	103"

Measuring Tools and Levels to Help with Your Installation
 Pages 230-232

Find Additional Sliding Door and Barn Door Hardware on Page 63

Screw Color Options*

Screws with Asterisk * are available in these colors, please specify when ordering.

Crimson	Polar White	Blue
Cocoa	Colony Green	Tan
Slate	Gray	Fern Green
Beige	Charcoal	Rustic Red
Gold	Emerald Green	Light Stone
	Galvalume Plus	

Tek Screws

- » Threaded fasteners with drill points.
- » Drill, tap and fasten in one operation to structural steel, galvanized steel, aluminum and other metal for numerous, fastening-to-metal applications.
- » Specify color when ordering.

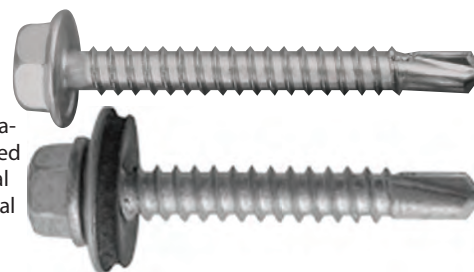

ITEM #	SCREW	SIZE	SEALING WASHER	FINISH	HEAD SIZE	DRIVER BIT
RA101634	TEK	#10 x 3/4"	No	Plated	5/16"	PB1016
RA10161	TEK	#10 x 1"	No	Plated	5/16"	PB1016
RA1016112	TEK	#10 x 1-1/2"	No	Plated	5/16"	PB1016
RA14141	TEK	1/4" x 1"	No	Plated	3/8"	PB1414
RA14141BLK	TEK	1/4" x 1"	No	Black	3/8"	PB1414
RA1414112	TEK	1/4" x 1-1/2"	No	Plated	3/8"	PB1414
BFT1234P	TEK	#12 x 3/4"	Yes	Plated	5/16"	PB1016

BFT121	TEK	#12 x 1"	Yes	Plated/Colors*	5/16"	PB1016
BFT12114	TEK	#12 x 1-1/4"	Yes	Plated/Colors*	5/16"	PB1016

*Available in Plated & Color Listed in Black Box (top left of page)

Lap-Tek Screws

- » Used to stitch two panels together at the overlap.
- » Specify color when ordering.



*Available in Plated & Colors Listed in Black Box (top of page)

ITEM #	SCREW	SIZE	SEALING WASHER	FINISH	HEAD SIZE	DRIVER BIT
BFL1478	LAP TEK	#14 x 7/8"	yes	Plated/Colors*	5/16"	PB1016

Woodgrip Screws

- » Used to attach a metal panel to wood framing.
- » Specify color when ordering.



*Available in Plated & Colors Listed in Black Box (top of page)

ITEM #	SCREW	SIZE	SEALING WASHER	FINISH	HEAD	DRIVER BIT
BFW101	Woodgrip	#10 x 1"	yes	Plated/Colors*	1/4"	PB11
BFW10112	Woodgrip	#10 x 1-1/2"	yes	Plated/Colors*	1/4"	PB11
BFW9112	Woodgrip	#9 x 1-1/2"	yes	Colors*	5/16"	PB1016



Magnetic Driver Bits

- » For Tek Screws, Lap-Tek Screws and Woodgrip Screws

ITEM #	SIZE
PB11	1/4"
PB1016	5/16"
PB1414	3/8"

Tri-Groove Fasteners



Bolt and Nut Sold Separately



- » 3/8"-16 thread
- » Angled nut resists pliers and saws
- » Special socket required for installation.

ITEM #	DESCRIPTION
TXFA3716BZ	1" Carriage Bolt
TXFATPNTG37	Tri-Groove Nut

Tri-Groove Socket



- » For use with 3/8"-16 tri-groove nuts to the left
- » Use this socket with any 3/8" drive ratchet to install or remove tri-groove nuts.

ITEM #	DESCRIPTION
TXFATRITool	Tri-Groove Socket

Hex Head Lag Screws

- » Type A
- » Hardened

BLACKSMITH BRAND



ITEM #	SIZE
HL141	1/4" x 1"
HL14112	1/4" x 1-1/2"
HL142	1/4" x 2"
HL143	1/4" x 3"
HL5161	5/16" x 1"
HL5162	5/16" x 2"
HL5163	5/16" x 3"
HL5164	5/16" x 4"
HL382	3/8" x 2"
HL383	3/8" x 3"
HL384	3/8" x 4"



Power Drivers for Hex Lag Screws

ITEM #	DESCRIPTION
PB14H	Driver for 1/4" Screws

Lag-Shield

- » Use in mortar joint or concrete
- » Use with: Lag bolt
- » Made of: Zinc alloy



ITEM #	SIZE
RA1051	1/4" Short
RA1055	1/4" Long
RA1101	5/16" Short
RA1105	5/16" Long
RA1151	3/8" Short
RA1155	3/8" Long

Projection Clips

- » For screens or storm window panel
- » Will not rust, are corrosion resistant
- » Screws not included



ITEM #	SCREW SIZE	DESCRIPTION
HL5003	#10	Black 5/16" Wing Clip
HL5002	#8	Black 3/8" Wing Clip

One-Way Lag Screws

- » Threaded full length
- » Hardened, Type A
- » Black finish
- » Can be installed with screwdriver or Power Bit

BLACKSMITH BRAND



ITEM #	SIZE
OW14112	1/4" x 1-1/2"
OW142	1/4" x 2"
OW14212	1/4" x 2-1/2"
OW143	1/4" x 3"
OW5162	5/16" x 2"
OW5163	5/16" x 3"

One Way Driver Bits

- » For fast installation of one-way screws



ITEM #	DESCRIPTION
PB14	Small for 1/4" screws
PB516	Large for 5/16" screws

Torx Tamper-Resistant Screws

- » Simple to install
- » Can only be removed with installation tool
- » Threaded full length
- » Black finish



TORX TAMPER RESISTANT

ITEM #	SIZE
TX14112	1/4" x 1 1/2"
TX142	1/4" x 2"
TX143	1/4" x 3"

Security Torx Driver Bit

- » Used with bit holder for installation of Torx tamper-resistant screws.



ITEM #	DESCRIPTION
PBT40	T40 Torx Bit



Magnetic Bit Holder

- » For Torx or other bits.
- » Bits not included.

ITEM #	DESCRIPTION
PA93551	1/4" Magnetic Bit Holder



Hand Bit Driver

- » For Torx or other bits.
- » Bits not included.

ITEM #	DESCRIPTION
PB14HD	1/4" Hand Bit Driver



Phillips Pan Head Screws

- » Black finish

ITEM #	SIZE
HL903	#8 x 1-1/4"
HL905	#10 x 1"
HL908	#10 x 2"

All-Thread Rod

NEW SIZES
Now Available in 6 Ft and 10 Ft

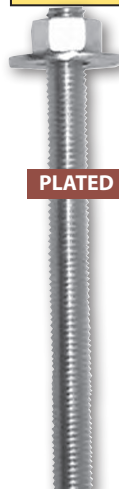

SIZE 3/8"	ITEM #
3 FT Rod	HLAT383
6 FT Rod	HLAT386
10 FT Rod	HLAT3810
Nut	HLAT38N
Washer	HLAT38W
SIZE 1/2"	ITEM #
3 FT Rod	HLAT123
6 FT Rod	HLAT126
10 FT Rod	HLAT1210
Nut	HLAT12N
Washer	HLAT12W
SIZE 5/8"	ITEM #
3 FT Rod	HLAT583
6 FT Rod	HLAT586
10 FT Rod	HLAT5810
Nut	HLAT58N
Washer	HLAT58W
SIZE 3/4"	ITEM #
3 FT Rod	HLAT343
6 FT Rod	HLAT346
10 FT Rod	HLAT3410
Nut	HLAT34N
Washer	HLAT34W

TURNBUCKLES, BOLTS, & WELD STUDS

NEW! Eye-Eye Turnbuckle *Hot Dipped Galvanized*



EYE OPENING (B)
See Chart to Left

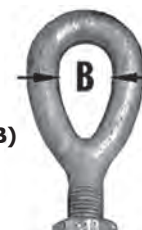

ITEM #	THREAD	TAKE-UP	OVERALL LENGTH	EYE OPENING	RATED CAPACITY (LBS)
HLATB12	1/2"	6"	19-15/16" OPEN 13-15/16" CLOSED	3/4"	2,200 LBS
HLATB58	5/8"	9"	27-11/16" OPEN 18-11/16" CLOSED	1 1/4"	3,500 LBS
HLATB34	3/4"	9"	29-5/8" OPEN 20-5/8" CLOSED	1"	5,200 LBS

NEW! Foundation Anchor Bolts *Hot Dipped Galvanized or Plain Steel*

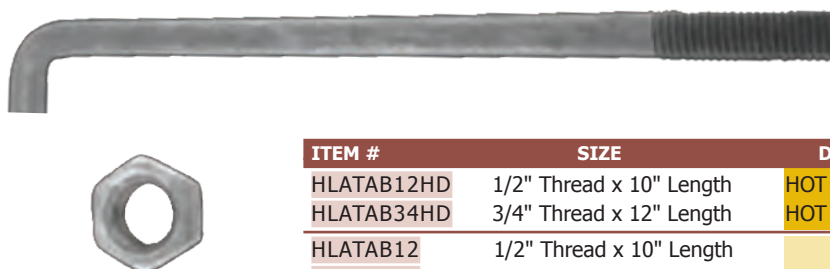

ITEM #	SIZE	DESCRIPTION
HLATAB12HD	1/2" Thread x 10" Length	HOT DIPPED GALVANIZED
HLATAB34HD	3/4" Thread x 12" Length	HOT DIPPED GALVANIZED
HLATAB12	1/2" Thread x 10" Length	PLAIN STEEL
HLATAB34	3/4" Thread x 12" Length	PLAIN STEEL

Weld Studs

Plain Steel



Sold Individually
or Box Quantity
(Price Break
Available on Box
Quantity)

Compare to
Nelson Studs®

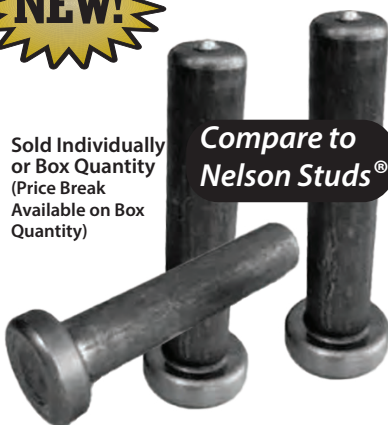

ITEM #	SIZE	BOX QUANTITY
RA7320	1/2" X 4-1/8"	190
RA7322	1/2" X 6-1/8"	110
RA7323	1/2" X 8-1/8"	90
RA7355	3/4" X 4-3/8"	90
RA7360	3/4" X 6-3/16"	60

Wedge-Bolt® +

Great for Mounting Racks & Fixtures

- » Zinc-plated carbon steel body and Hex head
- » Fully removable
- » Anchor is in one piece

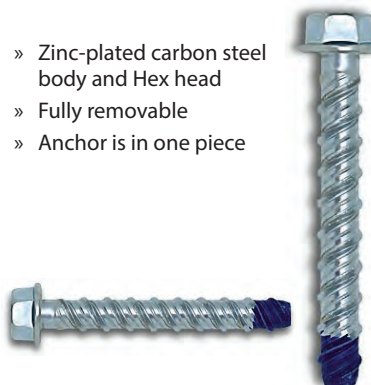

ITEM #	SIZE	BOX
RA7215	1/4" x 3"	1/4"
RA7216	3/8" x 4"	3/8"
RA7217	1/2" x 4"	1/2"
RA7218	1/2" x 5"	1/2"
RA7214	1/2" x 6"	1/2"
RA7219	5/8" x 4"	5/8"
RA7227	5/8" x 6"	5/8"

Zamac Nailin

*No Hole Spotting
One Piece*



- » Use in concrete, block, brick, stone
- » No other fastener needed
- » Made of zinc with steel nail

ITEM #	SIZE
RA2808	1/4" x 1"
RA2814	1/4" x 1-1/4"
RA2820	1/4" x 1-1/2"
RA2826	1/4" x 2"

Wedge Expansion Anchor

- » Designed for consistent performance in cracked and uncracked concrete
- » No other fastener needed
- » A one-piece anchor bolt made of low carbon steel



1. Position fixture and drill hole



2. Drive anchor into hole until nut and washer are flush with fixture

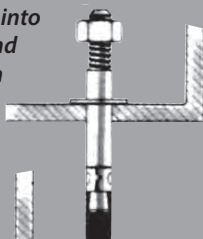

3. Tighten

4. Expansion will occur

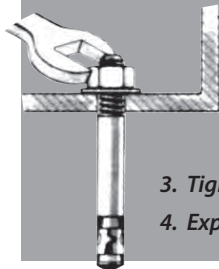

Use in: Solid Concrete, Stone (may be suitable), Grout-filled Block (may be suitable)

ITEM #	SIZE
RA7400	1/4" x 1-3/4"
RA7402	1/4" x 2-1/4"
RA7404	1/4" x 3"
RA7410	3/8" x 2-1/4"
RA7412	3/8" x 2-3/4"
RA7414	3/8" x 3-1/2"
RA7416	3/8" x 5"
RA7420	1/2" x 2-3/4"
RA7422	1/2" x 3-3/4"
RA7423	1/2" x 4-1/2"
RA7424	1/2" x 5-1/2"
RA7426	1/2" x 7"
RA7430	5/8" x 3-1/2"
RA7432	5/8" x 4-1/2"
RA7434	5/8" x 6"
RA7436	5/8" x 7"
RA7438	5/8" x 8-1/2"

Sleeve Expansion Anchor

- » A single unit sleeve anchor made of carbon steel
- » Sleeve has 360° contact area and reduces concrete stress



1. Position fixture and drill hole

2. Insert anchor into hole

3. Lightly tap until flush with fixture

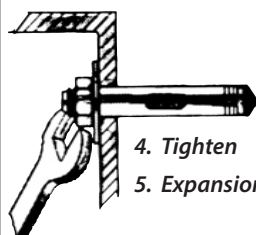

4. Tighten

5. Expansion will occur

Use in: Solid Concrete, Grout-filled Block, Hollow Concrete Block, Brick, Mortar

ITEM #	SIZE
RA5005	5/16" x 1-1/2"
RA5010	5/16" x 2-1/2"
RA5015	3/8" x 1-7/8"
RA5020	3/8" x 3"
RA5025	1/2" x 2-1/4"
RA5030	1/2" x 3"
RA5034	1/2" x 4"
RA5035	5/8" x 2-1/2"
RA5040	5/8" x 4-1/4"
RA5045	5/8" x 5-3/4"
RA5050	3/4" x 2-1/2"
RA5055	3/4" x 4-1/4"
RA5060	3/4" x 6-1/4"

Tapper™ Concrete Screw Anchor



Screw is the anchor, no need for additional mounting hardware



Hex Head



Phillips Flat-Head

- » High-low thread design
- » No hole spotting required
- » Drill bit included with box of 100
- » Perma-Seal™ coated carbon steel

Uses: Window Installations, Storm Shutters, Interior Hand Rails, Interior Lighting Fixtures

ITEM #	SIZE	HEAD	BOX QTY.
RA2724	1/4" x 2-1/4"	Hex Head	100
RA2728	1/4" x 3-1/4"	Hex Head	100
RA2732	1/4" x 4"	Hex Head	100
RA2764	1/4" x 2-1/4"	Phillips Flat Head	100
RA2768	1/4" x 3-1/4"	Phillips Flat Head	100
RA2772	1/4" x 4"	Phillips Flat Head	100
RA2776	1/4" x 6"	Phillips Flat Head	100

Short Spike

- » One-piece anchor
- » Zinc electroplated (meeting ASTM B-633)
- » High grade carbon steel
- » Tamper resistant



ITEM #	SIZE
RA3762	1/4" x 1-1/2"
RA3764	1/4" x 2"
RA3768	1/4" x 3"

Steel Cap-Plates

- » Sheared from 1/8" steel plate
- » Excellent for capping ends of tubing



NEW!
4 New Round Diameters!

BLACKSMITH BRAND

ITEM #	SIZE
WTCP2	2" x 2" Square
WTCP212	2-1/2" x 2-1/2" Square
WTCP3	3" x 3" Square
WTCP4	4" x 4" Square
WTCP6	6" x 6" Square
WTCP32	3" x 2" Rectangle
WTCP42	4" x 2" Rectangle
WTCP64	6" x 4" Rectangle
WTCP178R	1-7/8" Round
WTCP238R	2-3/8" Round
WTCP278R	2-7/8" Round
WTCP312R	3-1/2" Round
WTCP412R	4-1/2" Round
WTCP658R	6-5/8" Round

Steel Gussets and Base Plates

Custom Made to your Specs



BLACKSMITH BRAND

Have a Special Plate Requirement?

We can shear, punch, burn and waterjet cut custom sizes on request. Contact a sales representative for details.

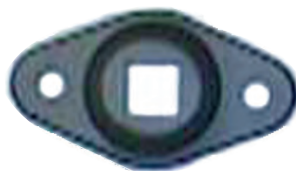

- » 2-5/8" x 1-1/2" » 1/2" Square ID
- » 1/4" Mounting Holes » 3/32" Thick

BLACKSMITH BRAND

ITEM #	FITS	OVERALL DIMS.
WT110	1/2"	2-5/8" x 1-1/2"

Raised Square Flanges

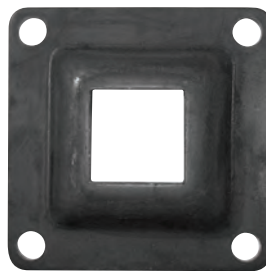

- » 1/8" Thick
- » 7/16" mounting holes

BLACKSMITH BRAND

ITEM #	FITS	OVERALL DIMS.
WT8041	1" sq. Tube	4" sq.
WT135	1-1/4" sq. Tube	4" sq.
WT8047	1-1/2" sq. Tube	4" sq.
WT137	2" sq. Tube	5-1/4" sq.
WT8049	2-1/2" Tube	5" sq.

1" Tubing Corner

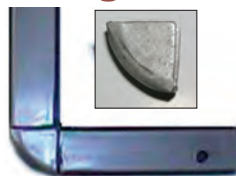

BLACKSMITH BRAND

ITEM #	DESCRIPTION
SC1C	Hole in 1 leg

2-3/4" x 1" Weld Tab

- » 3/8" Hole
- » 3/16" Thick

BLACKSMITH BRAND

ITEM #
WT300

3-1/2" x 1" Weld Tab

- » 3/8" Hole
- » 5/32" Thick

BLACKSMITH BRAND

ITEM #
WT217

2-3/8" x 1" Weld Tab

- » 3/4" x 1/4" Oblong Hole
- » 1/8" Thick

ITEM #
WT132

2" 90° Weld Tab

- » With 1-1/8" x 3/8" oblong hole in one leg
- » Both legs are 2" in length
- » 1" wide x 3/16" thick

ITEM #
WT412

1-1/2" 90° Weld Tab

- » With 3/8" hole in 1 leg or Both legs
- » Both legs are 1-1/2" in length
- » 1" wide x 1/8" thick

ITEM #	DESCRIPTION
WT231	Hole in 1 leg
WT232	Hole in Both legs



- » 2 5/8" high
- » 2" wide
- » 1/8" thick
- » 1" base
- » 3/8" hole



ITEM #
WT3



- » 3" high
- » 3" wide
- » 7/8" extension
- » 3/8" hole



ITEM #
WT5



- » 3 1/2" high
- » 1 1/2" extension
- » 1" wide
- » 1/8" thick
- » 3/8" hole



ITEM #
WT8



- » 1 5/8" high
- » 1" wide
- » 1/8" thick
- » 3/8" hole



ITEM #
WT4



- » 2 1/2" high
- » 1 1/2" wide
- » 1/8" thick
- » 3/8" hole



ITEM #
WT9



- » 2 1/4" high
- » 1" wide
- » 1/8" thick
- » 3/8" hole



ITEM #
WT2

Decorative Base Plates



- » 3-15/16" Square
- » 5/16" Thick
- » 1.4 lbs

ITEM #
CI94A3



- » 3-5/32" Square
- » 5/16" Thick
- » 0.9 lbs

ITEM #
CI94A4

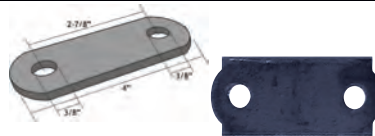

- » 3/8" holes
- » 4" long
- » 1 1/2" wide
- » 3/16" thick
- » 3 7/16" long
- » 1 1/2" wide
- » 3/16" thick



ITEM #
WT13

ITEM #
WT6

Square Base Plates



Four
3/8" holes

Plain Steel Base Plates

ITEM #	PLAIN STEEL	THICK
WT6B	3" x 3"	3/16"
WT7	4" x 4"	3/16"
WT115	5" x 5"	3/16"
WT11	6" x 6"	1/4"
WT12	8" x 8"	1/4"

Zinc-Plated Base Plates

ITEM #	ZINC PLATED	THICK
WT6BG	3" x 3"	3/16"
WT7G	4" x 4"	3/16"
WT115G	5" x 5"	3/16"
WT12G	8" x 8"	1/4"

Heavy Duty 2" x 1" 90° Weld Tab

- » With 5/8" x 1" hole in 2" leg
- » Other leg is 1" in length
- » 1" wide by 3/16" thick



ITEM #
WT112

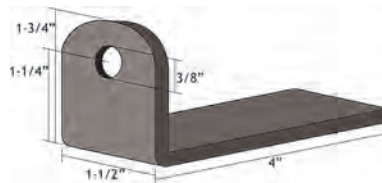

- » 3/8" hole
- » 4" long
- » 1 1/2" wide
- » 3/16" thick



ITEM #
WT14

Aluminum Die Cast Dome Caps



Larger, Steel Postcaps Available on Page 106

Slides over the Pipe O.D. measurements listed below.

ITEM #	POST SIZE	MATERIAL
SC138AL	1-3/8" OD	Aluminum
SC158AL	1-5/8" OD	Aluminum
SC178AL	1-7/8" OD	Aluminum
SC238AL	2-3/8" OD	Aluminum

Square Post Caps 3 Material Types

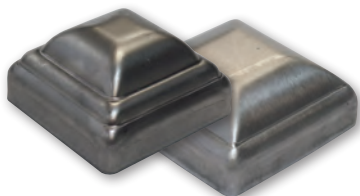

Your Choice of Pressed Steel, Aluminum or Galvanized

» No welding necessary - cap fits tight.

ITEM#	POST SIZE	MATERIAL
SC114	1-1/4"	Pressed Steel
SC112	1-1/2"	Pressed Steel
SC2	2"	Pressed Steel
SC212	2-1/2"	Pressed Steel
SC3	3"	Pressed Steel
SC4	4"	Pressed Steel
SC5	5"	Pressed Steel
SC6	6"	Pressed Steel
SC8	8"	Pressed Steel
SC114A	1-1/4"	Aluminum
SC112A	1-1/2"	Aluminum
SC2A	2"	Aluminum
SC3A	3"	Aluminum
SC4A	4"	Aluminum
SC2GAL	2"	Galvanized
SC212GAL	2-1/2"	Galvanized
SC3GAL	3"	Galvanized
SC312GAL	3-1/2"	Galvanized
SC4GAL	4"	Galvanized

Flat-Top Square Post Caps

Cap Dimensions Run True to Size



Available in Pressed Steel

» No welding necessary - cap fits tight.

ITEM#	POST SIZE	MATERIAL
SC112FT	1-1/2"	Pressed Steel
SC2FT	2"	Pressed Steel
SC212FT	2-1/2"	Pressed Steel
SC3FT	3"	Pressed Steel
SC4FT	4"	Pressed Steel
SC5FT	5"	Pressed Steel
SC6FT	6"	Pressed Steel
SC8FT	8"	Pressed Steel

Cast Iron Square Newel Post Caps



ITEM #	POST SIZE	MATERIAL
CI805	1"	Cast Iron
CI804	1 1/4"	Cast Iron
CI806	1-1/2"	Cast Iron
CI807	2"	Cast Iron
CI8212	2-1/2"	Cast Iron
CI808	3"	Cast Iron
CI809	4"	Cast Iron
CI810	5"	Cast Iron
CI811	6"	Cast Iron

Plastic Square Post Cap

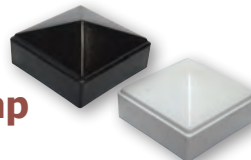

» An economical alternative to cast iron

ITEM#	POST SIZE	COLOR
PS807B	2"	Black Plastic
PS807W	2"	White Plastic
PS808B	3"	Black Plastic
PS808W	3"	White Plastic

Plastic Decorative Ball Cap

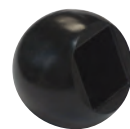

» Fits 1/2" square
» Provides protection from sharp edges.



ITEM #	TUBE SIZE	BALL SIZE
PPP12	1/2"	1" Dia.

Nickel-Plated Metal Spring Caps

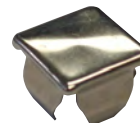

» Fits 16 or 18 gauge tubing

ITEM #	TUBE SIZE	TUBE GAUGE
SC34P	3/4" tube	16 or 18 gauge

Non-Skid Leveler

» 1" threaded stem length



ITEM #	THREAD SIZE	BASE SIZE
PP7B14	1/4"-20	1-1/8" Dia.
PP7B38	3/8"-16	1-1/8" Dia.

Two-Sided Metal Threaded Greater Clip



» Fits 16 or 18 ga tubing
» 1/4"-20 threaded hole for leveler

ITEM #	TUBE SIZE	TUBE GAUGE
PP71	1" tube	16 or 18 gauge

FITS PP7B14

Four Sided Metal Threaded Greater Clips



» Fits 16 or 18 gauge tubing
» 3/8"-16 threaded hole for leveler

ITEM #	TUBE SIZE	TUBE GAUGE
PP7112	1-1/2" tube	16 or 18 gauge

FITS PP7B38

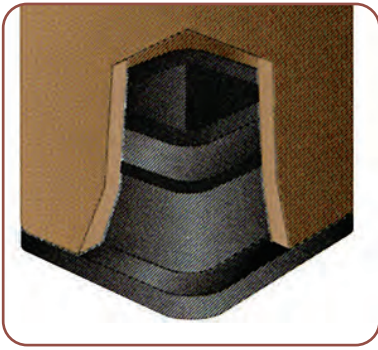

High Quality Plastic Tube Plug

- » High grade plastic
- » Black or white finish



ITEM #	SIZE	GA.	COLOR
PP12	1/2" x 1/2"	16	Black
PP12W	1/2" x 1/2"	16	White
PP58	5/8" x 5/8"	16	Black
PP34	3/4" x 3/4"	16	Black
PP116	1" x 1"	16	Black
PP116W	1" x 1"	16	White
PP111	1" x 1"	11	Black
PP11416	1-1/4" x 1-1/4"	16	Black
PP11411	1-1/4" x 1-1/4"	11	Black
PP11216	1-1/2" x 1-1/2"	16	Black
PP11211	1-1/2" x 1-1/2"	11	Black
PP216	2" x 2"	16	Black
PP211	2" x 2"	11	Black
PP214	2" x 2"	14	Black
PP2116	2" x 1"	16	Black



Polyethylene Ribbed Style Square Tubing Plug

- » Black finish

ITEM #	TUBE SIZE	TUBE GA.	COLOR
PPSQ58	5/8"	14-18	Black
PPSQ6	3/4"	14-20	Black
PPSQ8	1"	14-20	Black
PPSQ10	1-1/4"	14-20	Black
PPSQ12	1-1/2"	14-20	Black
PPD210	2"	14-18	Black
PPD222	2"	10-14	Black
PPSQ201	2-1/2"	11-19	Black
PPSQ6241	3"	14-20	Black
PPSQ4	4"	7-11	Black

Plastic Finial

Find Additional Plastic Finial Options on Page 100

PLASTIC

- » Height 4 1/4"

ITEM#	PICKET SIZE	COLOR
PSM30	1/2"	Black
PSM30W	1/2"	White
PSM3058	5/8"	Black
PSM34	3/4"	Black
PSM34W	3/4"	White

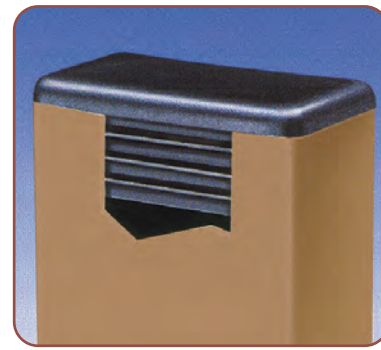

Polyethylene Ribbed Style Rectangular Tubing Plug

- » Black finish

ITEM #	TUBE SIZE	TUBE GA.	COLOR
PPRC1020	1" x 2"	14-18	Black
PPRC15301	1-1/2" x 3"	10-16	Black
PPRC20301	2" x 3"	8-14	Black
PPRC20401	2" x 4"	10-14	Black

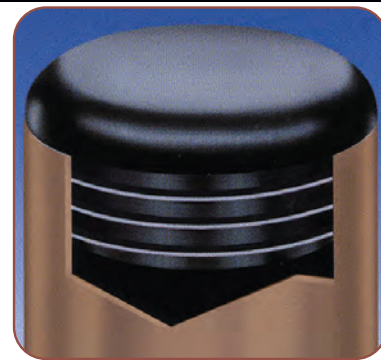

Polyethylene Ribbed Style Round Tubing Plug

- » Black finish
- » Low cost universal closures

ITEM #	TUBE SIZE	TUBE GA.	COLOR
PPRT6	3/4"	14-20	Black
PPRT8	1"	14-20	Black
PPRT10	1-1/4"	14-20	Black
PPRT12	1-1/2"	14-20	Black
PPRT16	2"	14-20	Black

Heavy Duty Stamped Steel Handrail Bracket

- » Can be used with round or square handrails
- » Stamped from 3/16" black steel
- » **Offset:** Wall to Center of Handrail

ITEM #	OFFSET
SC35B	3"

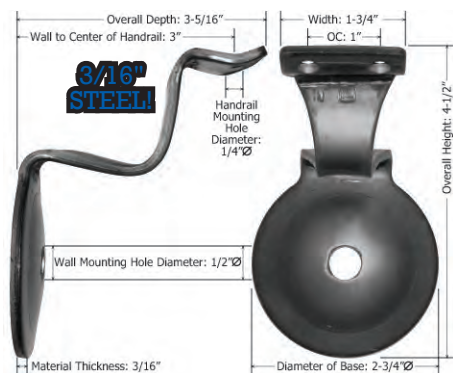

Stamped Steel Handrail Bracket

- » Can be used with round or square handrails
- » Stamped from 1/8" steel
- » **Offset:** Wall to Center of Handrail

ITEM #	OFFSET
SC35BRP	2-5/8"



Cast Iron Handrail Bracket

- » For square handrails
- » Textured finish
- » **Offset:** Wall to Center of Handrail

ITEM #	OFFSET
CI3A	2-3/8"
CI3B	3"

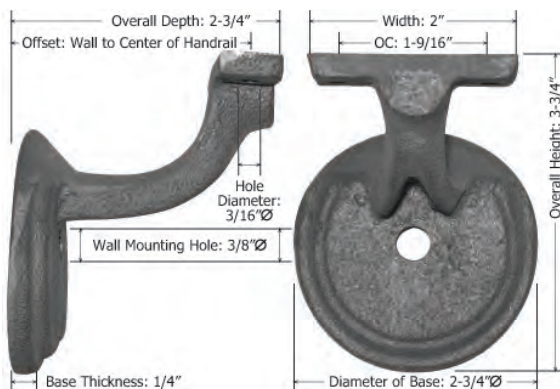

Extra Heavy Duty Stamped Steel Handrail Bracket

- » Stamped from 1/4" steel
- » **Offset:** Wall to Center of Handrail

ITEM #	OFFSET
SC1938	3"
SC1930	2-1/2"



- » Matte finish
- » Saddle fits 1.50" thru 3.00" OD and flat surfaces

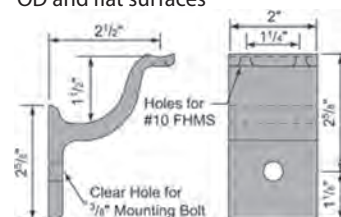

ITEM #	WALL OFFSET	BASE SIZE
SCAL8103	2-1/2"	2" x 2-5/8"

Stainless Steel Designer Heavy Duty Wall-Mounted Handrail Support



- » 90° fixed position
- » 304 stainless steel with satin finish
- » Four piece set includes flange, flange cover, elbow, and rail mounting plate.
- » **Offset:** Wall to Center of Handrail

ITEM #	WALL OFFSET	FLANGE	ELBOW
SFE022S	3-1/4"	2-1/2"	3/4"

Forged Handrail Bracket

STEEL

- » No base plate
- » Material: 1/2" square
- » Rail Mounting Plate: 1" x 4" x 1/4" thick



ITEM #	WALL OFFSET	BASE SIZE
CI14051	2-7/8"	N/A

Round Bar Handrail Bracket

STEEL

- » Three hole base plate
- » Material: 5/8" round, distressed
- » Rail Mounting Plate: n/a
- » **Offset:** Wall to Center of Handrail



ITEM #	WALL OFFSET	BASE SIZE
CI14053	2-3/4"	3-1/4"

Ornamental Handrail Bracket

STEEL

- » Two hole rosette base plate
- » Material: 1/2" round, decorative
- » **Offset:** Wall to Center of Handrail



ITEM #	WALL OFFSET	BASE SIZE
CI94A1	3"	3-5/8"

Hammered Handrail Bracket

STEEL

- » Three hole base plate
- » Material: 1/2" square, hammered
- » Rail Mounting Plate: 1" x 4" x 1/4" thick
- » **Offset:** Wall to Center of Handrail



ITEM #	WALL OFFSET	BASE SIZE
CI14052	2-3/4"	3-1/4"

Cast Iron Handrail Bracket

CAST IRON

- » For 1-1/2" round tubing
- » Rail Mounting Plate: 1-3/8" x 2-3/4" x 1/8" thick
- » **Offset:** Wall to Center of Handrail



ITEM #	WALL OFFSET	BASE SIZE
CI3HRB	3-1/2"	3-3/4"





Heavy Duty Steel Flanges

- » For round pipe
- » 1/8" material thickness
- » Three or four hole styles

ITEM #	MATERIAL THICKNESS	HOLE DIA.	FITS PIPE	# OF MTG. HOLES	MTG. HOLE DIAMETER	OVERALL DIAMETER
SC13152	1/8"	1.315"	1"	3	1/4"	3-1/2"
SC114F	1/8"	1.66"	1-1/4"	3	5/16"	3-3/4"
SC1144H	1/8"	1.66"	1-1/4"	4	5/16"	3-3/4"
SC112F	1/8"	1.90"	1-1/2"	4	5/16"	4-1/4"
SC2375F	1/8"	2-3/8"	2"	3	3/8"	4-5/8"

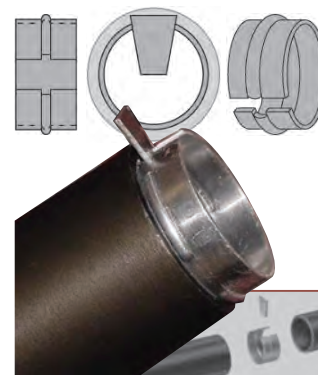

Wedge-Lock Welding Pipe Joint Connectors

- » For quickly aligning and welding 1-1/4" and 1-1/2" steel pipe
- » No chamfering necessary
- » Leaves a 1/8" gap between joints to allow for weld bead.

ITEM #	FITS PIPE	TUBE OD	WALL
SCWL114	1-1/4" Sch. 40	1.66"	.140"
SCWL112	1-1/2" Sch. 40	1.90"	.145"



Flange

Designed to Work with Snap-On Base Cover

- » 1/4" steel thickness
- » Four mounting holes
- » Built for snap on base covers below

ITEM #	HOLE DIA.	FITS PIPE	DIA.
SC166S	1.66"	1-1/4"	4-5/16"
SC190S	1.90"	1-1/2"	4-5/16"

Flange Cover

Snaps Over Flange

- » Snap-on cover
- » 18 gauge steel



ITEM #	HOLE DIA.	FITS PIPE	DIA.
SC166C	1.66"	1-1/4"	4-1/2"
SC190C	1.90"	1-1/2"	4-1/2"



Raised Cover Plate

- » 1/8" thick, for 1-1/4" pipe

ITEM #	HOLE DIA.	FITS PIPE	DIA.
SC250	1.66"	1-1/4"	3-7/8"

Steel Flanges for Square Tubing

- » An attractive cover plate for square tubing bases

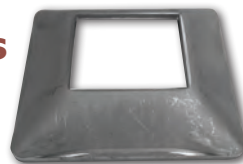

ITEM #	TUBE SIZE	WIDTH
SC112FSQ	1-1/2"	3"
SC2FSQ	2"	4"

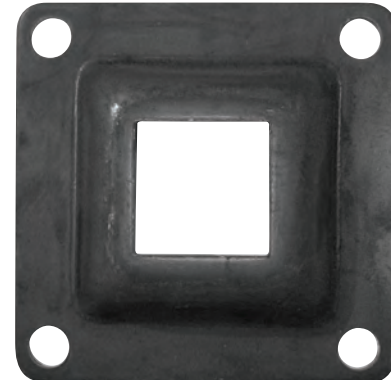

Raised Square Flanges

- » 1/8" Thick
- » 7/16" mounting holes



ITEM #	FITS	OVERALL DIMS.
WT8041	1" sq. Tube	4" sq.
WT135	1-1/4" sq. Tube	4" sq.
WT8047	1-1/2" sq. Tube	4" sq.
WT137	2" sq. Tube	5-1/4" sq.
WT8049	2-1/2" Tube	5" sq.

Weld On Pipe End Caps

- » Sch. 40
- » Bevelled edges for easy welding
- » Carbon steel



ITEM #	PIPE DESCRIPTION	SIZE ID
ELCAP1	1"	End Cap
ELCAP114	1-1/4"	End Cap
ELCAP112	1-1/2"	End Cap
ELCAP2	2"	End Cap
ELCAP212	2-1/2"	End Cap
ELCAP3	3"	End Cap
ELCAP4	4"	End Cap
ELCAP5	5"	End Cap
ELCAP6	6"	End Cap

Stamped Steel Pipe End Caps



- » Stamped from heavy gauge steel
- » Non-fluid and non-pressure related applications

ITEM #	PIPE O.D.	DESCRIPTION
SC114RP	1-5/8"	Flat End Cap
SC112RP	1-7/8"	Flat End Cap
SC2RP	2-3/8"	Flat End Cap
SC212RP	2-7/8"	Flat End Cap
SC3RP	3-1/2"	Flat End Cap
SC312RP	4"	Flat End Cap
SC4RP	4-1/2"	Flat End Cap
SC5RP	5-1/2"	Flat End Cap
SC6RP	6-5/8"	Flat End Cap
SC8RP	8-5/8"	Flat End Cap

Seamless Weld-On Pipe Elbows



- » Carbon steel
- » Schedule 40
- » Long Radius
- » Beveled edges ready for easy welding

ITEM #	PIPE SIZE I.D.	DESC.
EL1245	1/2"	45° Bend
EL3445	3/4"	45° Bend
EL145	1"	45° Bend
EL11445	1-1/4"	45° Bend
EL11245	1-1/2"	45° Bend
EL245	2"	45° Bend
EL21245	2-1/2"	45° Bend
EL345	3"	45° Bend
EL445	4"	45° Bend
EL645	6"	45° Bend

ITEM #	PIPE SIZE I.D.	DESC.
EL1290	1/2"	90° Bend
EL3490	3/4"	90° Bend
EL190	1"	90° Bend
EL11490R	1-1/4"	90° Bend
EL11290	1-1/2"	90° Bend
EL290	2"	90° Bend
EL21290	2-1/2"	90° Bend
EL390	3"	90° Bend
EL490	4"	90° Bend
EL690	6"	90° Bend

Pressed Steel Dome Caps

Slides over Pipe O.D. measurements listed below.



ITEM #	PIPE O.D.	DESC.
SC16589	3-1/2"	End Cap
SC165102	4"	End Cap
SC165114	4-1/2"	End Cap

90° Pipe Railing Elbows

- » With seam
- » Long radius; 1" inner radius
- » Made from mild steel; SCH40
- » Great for handrails and other non-fluid, non-pressure applications

MADE IN THE USA



ITEM #	PIPE SIZE I.D.	DESC
EL11490S	1-1/4"	90° Bend
EL11290S	1-1/2"	90° Bend

Weld-On Pipe "T" S

- » Bevelled edges
- » Carbon Steel
- » Schedule 40 pipe



ITEM #	PIPE SIZE I.D.	DESC
ELTE1	1"	90°/180° T
ELTE114	1-1/4"	90°/180° T
ELTE112	1-1/2"	90°/180° T
ELTE2	2"	90°/180° T
ELTE212	2-1/2"	90°/180° T
ELTE3	3"	90°/180° T
ELTE4	4"	90°/180° T
ELTE6	6"	90°/180° T

Steel Dished Drive-On Caps



ITEM #	OUTSIDE DIA.	FITS PIPE
SC114DOC	1.66"	1-1/4" SCH 40
SC112DOC	1.90"	1-1/2" SCH 40

Steel Flat Drive-On Caps



ITEM #	OUTSIDE DIA.	FITS PIPE
SC166FC	1.66"	1-1/4" SCH 40 pipe
SC190FC	1.90"	1-1/2" SCH 40 pipe

Aluminum Die Cast Dome Caps

Slides over Pipe O.D. measurements listed below.



ITEM #	PIPE O.D.	DESC.
SC138AL	1-3/8"	Post Cap
SC158AL	1-5/8"	Post Cap
SC178AL	1-7/8"	Post Cap
SC238AL	2-3/8"	Post Cap

NEW!

Larger, Steel Postcaps Available on Pages 78 & 106



Pre-Punched Rollformed Channel

Economically Priced

Available Punched or Unpunched!



Square Hole 1" x 1/2" x 1/8" Rollformed Channel



ITEM #	CHANNEL SIZE	HOLE SIZE	FITS PICKET	OPEN AREA	ON CENTER
PBCR1004	1" x 1/2" x 1/8"	9/16"	1/2" Square	3-1/2"	4"
PBCR100412	1" x 1/2" x 1/8"	9/16"	1/2" Square	4"	4-1/2"
PBCR1005	1" x 1/2" x 1/8"	9/16"	1/2" Square	4-1/2"	5"
PBCR1006	1" x 1/2" x 1/8"	9/16"	1/2" Square	5-1/2"	6"

Square Hole 1-1/2" x 1/2" x 1/8" Rollformed Channel

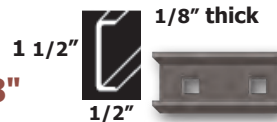

ITEM #	CHANNEL SIZE	HOLE SIZE	FITS PICKET	OPEN AREA	ON CENTER
PBCR1120412	1-1/2" x 1/2" x 1/8"	9/16"	1/2" Square	3-1/2"	4"
PBCR1120512	1-1/2" x 1/2" x 1/8"	9/16"	1/2" Square	4-1/2"	5"
PBCR1120612	1-1/2" x 1/2" x 1/8"	9/16"	1/2" Square	5-1/2"	6"
PBCR1120434	1-1/2" x 1/2" x 1/8"	13/16"	3/4" Square	3-1/4"	4"
PBCR1120534	1-1/2" x 1/2" x 1/8"	13/16"	3/4" Square	4-1/4"	5"
PBCR1120634	1-1/2" x 1/2" x 1/8"	13/16"	3/4" Square	5-1/4"	6"

Square Hole 2" x 1" x 1/8" Rollformed Channel



ITEM #	CHANNEL SIZE	HOLE SIZE	FITS PICKET	OPEN AREA	ON CENTER
PBCR2118434	2" x 1" x 1/8"	13/16"	3/4" Square	3-1/4"	4"
PBCR2118534	2" x 1" x 1/8"	13/16"	3/4" Square	4-1/4"	5"
PBCR2118634	2" x 1" x 1/8"	13/16"	3/4" Square	5-1/4"	6"



Fabrication Ease: Slide pickets through the punched holes and tack-weld. Attach to posts and your fence is built.

Pre-Punched Rollformed Channel

- » Stocked in 20' lengths
- » Every hole exactly on center
- » Great for window guards and fences
- » NEW automated punching technique
- » Provide extra security for doors, window guards and fencing



1" Rollformed Channel

- » 1" x 1/2" x 1/8"
- » 20 ft. length



1-1/2" Rollformed Channel

- » 1-1/2" x 1/2" x 1/8"
- » 20 ft. length



2" Rollformed Channel

- » 2" x 1" x 1/8"
- » 20 ft. length

Unpunched Rollformed Channel

- » Used for flush top or bottom
- » 20 foot length



ITEM #	CHANNEL SIZE
PBCR1000	1" x 1/2" x 1/8"
PBCR1120000	1-1/2" x 1/2" x 1/8"
PBCR2000	2" x 1" x 1/8"

Square Hole 1" x 1/2" x 1/8" Bar Channel



ITEM #	CHANNEL	HOLE	FITS PICKET	OPEN AREA	CENTER
PBC1004	1" x 1/2" x 1/8"	9/16"	1/2" Square	3-1/2"	4"
PBC100412	1" x 1/2" x 1/8"	9/16"	1/2" Square	4"	4-1/2"
PBC1005	1" x 1/2" x 1/8"	9/16"	1/2" Square	4-1/2"	5"
PBC1006	1" x 1/2" x 1/8"	9/16"	1/2" Square	5-1/2"	6"

Square Hole 1-1/2" x 1/2 x 1/8" Bar Channel



ITEM #	CHANNEL SIZE	HOLE SIZE	FITS PICKET	OPEN AREA	CENTER
PBC1120412	1-1/2" x 1/2" x 1/8"	9/16"	1/2" Square	3-1/2"	4"
PBC11241212	1-1/2" x 1/2" x 1/8"	9/16"	1/2" Square	4"	4-1/2"
PBC1120512	1-1/2" x 1/2" x 1/8"	9/16"	1/2" Square	4-1/2"	5"
PBC1120612	1-1/2" x 1/2" x 1/8"	9/16"	1/2" Square	5-1/2"	6"
PBC11241258	1-1/2" x 1/2" x 1/8"	11/16"	5/8" Square	3-7/8"	4-1/2"
PBC1120558	1-1/2" x 1/2" x 1/8"	11/16"	5/8" Square	4-3/8"	5"
PBC1120434	1-1/2" x 1/2" x 1/8"	11/16"	3/4" Square	3-1/4"	4"
PBC11243434	1-1/2" x 1/2" x 1/8"	11/16"	3/4" Square	4"	4-3/4"
PBC1120634	1-1/2" x 1/2" x 1/8"	11/16"	3/4" Square	5-1/4"	6"

Square Hole 2" x 1" x 1/8" Bar Channel



ITEM #	CHANNEL SIZE	HOLE SIZE	FITS PICKET	OPEN AREA	CENTER
PBC2118458	2" x 1" x 1/8"	11/16"	5/8" Square	3-3/8"	4"
PBC2118558	2" x 1" x 1/8"	11/16"	5/8" Square	4-3/8"	5"
PBC2118434	2" x 1" x 1/8"	13/16"	3/4" Square	3-1/4"	4"
PBC2118534	2" x 1" x 1/8"	13/16"	3/4" Square	4-1/4"	5"
PBC2118634	2" x 1" x 1/8"	13/16"	3/4" Square	5-1/4"	6"
PBC211851	2" x 1" x 1/8"	1-1/16"	1" Square	4"	5"
PBC211861	2" x 1" x 1/8"	1-1/16"	1" Square	5"	6"

SPECIAL ORDER ONLY - 10 PIECE MINIMUM

Square Hole 1-1/2" x 3/4" x 1/8 Bar Channel

ITEM #	CHANNEL SIZE	HOLE SIZE	FITS PICKET	OPEN AREA	CENTER
PBC11234412	1-1/2" x 3/4" x 1/8	9/16"	1/2" Square	3-1/2"	4"
PBC1123441212	1-1/2" x 3/4" x 1/8	9/16"	1/2" Square	4"	4-1/2"
PBC11234512	1-1/2" x 3/4" x 1/8	9/16"	1/2" Square	4-1/2"	5"
PBC11234612	1-1/2" x 3/4" x 1/8	9/16"	1/2" Square	5-1/2"	6"
PBC1123441258	1-1/2" x 3/4" x 1/8	11/16"	5/8" Square	3-7/8"	4-1/2"
PBC11234558	1-1/2" x 3/4" x 1/8	11/16"	5/8" Square	4-3/8"	5"
PBC11234434	1-1/2" x 3/4" x 1/8	13/16"	3/4" Square	3-1/4"	4"
PBC1123443434	1-1/2" x 3/4" x 1/8	13/16"	3/4" Square	4"	4-3/4"
PBC11234634	1-1/2" x 3/4" x 1/8	13/16"	3/4" Square	5-1/4"	6"

Pre-Punched Structural Bar Channel



Stocked in
20 ft. Lengths

Custom Bar Channel Hole Punching



Call Us

Tube Gate Arches

1-1/2" AND 2" STOCK SIZES AVAILABLE

Build Custom Arched Gates With These Heavy-Duty Gate Arches
Arched Square Tubing Available In Heavy 14 & 11 Gauge Material
Lengths from 8 Ft. To 16 Ft. in Unfinished Plain Steel

NOTE:

Approximately 2 feet is added to the length of the arch, allowing the customer a margin of error.

Example: 16 foot arch will measure 18 feet wide when purchased, 12 foot will measure 14, etc.

There is often a 2-inch leeway on the rise.

Example: A 14-inch rise may measure 13-16 inches.

If needed, the rise can be controlled when trimming the arch length by cutting only one side.

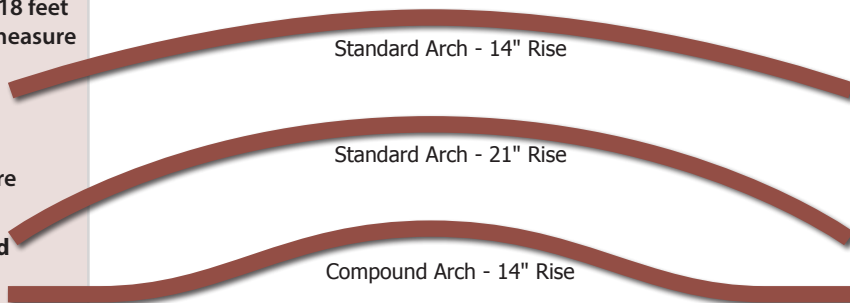

Square Tube Standard Arches - 14" Rise

ITEM#	SIZE	THK	LGTH	RISE
GAA112814S	1-1/2"	14 ga	8 ft.	14"
GAA1121214S	1-1/2"	14 ga	12 ft.	14"
GAA1121614S	1-1/2"	14 ga	16 ft.	14"
GAA2814S	2"	11 ga	8 ft.	14"
GAA21214S	2"	11 ga	12 ft.	14"
GAA21614S	2"	11 ga	16 ft.	14"

Square Tube Standard Arches - 21" Rise

ITEM#	SIZE	THK	LGTH	RISE
GAA112821S	1-1/2"	14 ga	8 ft.	21"
GAA1121221S	1-1/2"	14 ga	12 ft.	21"
GAA1121621S	1-1/2"	14 ga	16 ft.	21"
GAA2821S	2"	11 ga	8 ft.	21"
GAA21221S	2"	11 ga	12 ft.	21"
GAA21621S	2"	11 ga	16 ft.	21"

Square Tube Compound Arches - 14"

ITEM#	SIZE	THK.	LENGTH	RISE
GAA112814C	1-1/2"	14 ga	8 ft.	14"
GAA1121214C	1-1/2"	14 ga	12 ft.	14"
GAA1121614C	1-1/2"	14 ga	16 ft.	14"
GAA2814C	2"	11 ga	8 ft.	14"
GAA21214C	2"	11 ga	12 ft.	14"
GAA21614C	2"	11 ga	16 ft.	14"

Arched Gate Kits

Pre-punched Rails on 5" Centers for 1/2" Square Bar or Tube to be Used with 1-1/2" Tube for Upright Posts

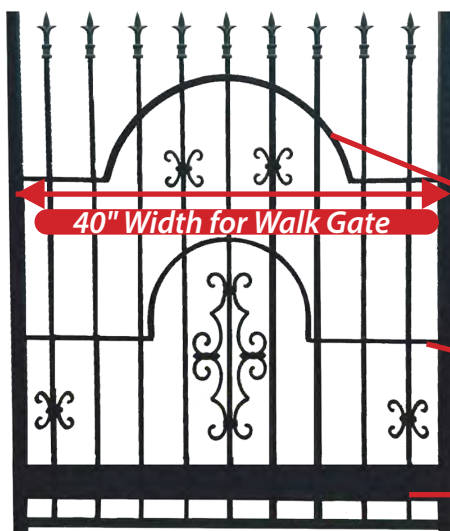

Kit Includes a 3-Piece Set for a 3-Rail Gate

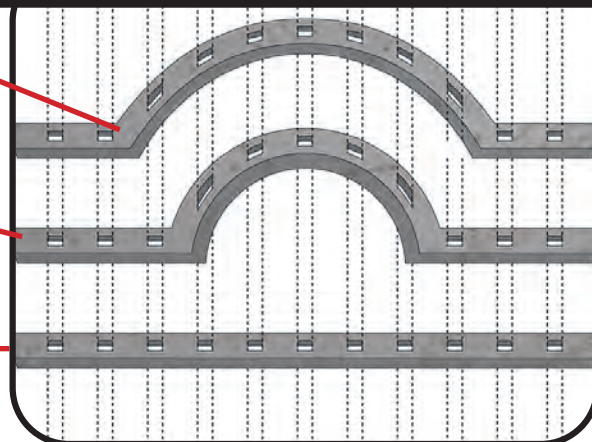

ITEM #	DESCRIPTION
GHARCH40	40" Arched Gate Kit

3/16 LASER CUT STEEL STAR IN CIRCLE



- » Thicker, heavier weight; 3/16 steel
- » Laser cut offers smooth edges with precise curves and angles
- » 24" Outer Dia.
- » This item is not painted; raw steel

ITEM #	DESCRIPTION
FC525	24" Laser Cut Steel Star

3/16 LASER CUT STEEL LETTERS / NUMBERS

Advantages

- Thicker, heavier weight than most steel letters/numbers
- Offers smooth edges with precise curves and angles
- Two sizes; 6" / 10"



ABCD12345



ABCD12345

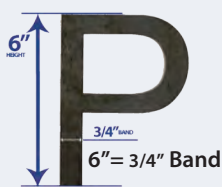

ABCD12345



ABCD12345

LETTERS

ITEM #	DESCRIPTION
FC106 + Character	6"
FC101 + Character	10"

NUMBERS

ITEM #	DESCRIPTION
FC106 + Number	6"
FC101 + Number	10"

Expanding Security Door Gates

Available in Single | Double | Custom



Choose From
**Stock Sizes or
Custom-Made**



Single

- » Designed to provide security for various door openings
- » Made of a sturdy 3/4" channel
- » Painted with black enamel
- » Gates will pivot 180° out of the way when open
- » **EGE65S and EG770S** have a drop pin in the center for extra stability in wider openings

ITEM #	WIDTH	COLLAPSED HEIGHT	IN USE HEIGHT	
EG36D	32 in. to 3 ft.	79 in.	75 in.	SINGLE
EG465S	3 ft. to 4 ft.	6-1/2 ft.	6 ft.	SINGLE
EG770S	6 ft. to 7 ft.	7 ft.	6-1/2 ft.	SINGLE

Control Access without Loss of Visibility

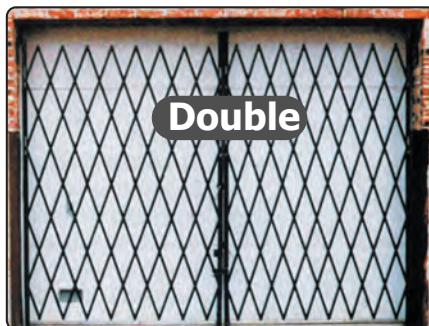

Double

- Double gate are shipped complete with:
- 2 Mounting brackets
 - 2 Washers
 - 2 Casters
 - Drop-pin
 - H-bracket

- » Each side of gate will pivot 180°
- » Gates drop an inch per foot upon expansion
- » Black enamel paint

ITEM #	WIDTH	COLLAPSED HEIGHT	IN USE HEIGHT
EG1065D	8' to 10'	6-1/2'	6'
EG1070D	8' to 10'	7'	6-1/2'
EG1075D	8' to 10'	7-1/2'	7'
EG1085D	8' to 10'	8-1/2'	8'
EG1265D	10' to 12'	6-1/2'	6'
EG1275D	10' to 12'	7-1/2'	7'
EG1465D	12' to 14'	6-1/2'	6'
EG1670D	14' to 16'	7'	6-1/2'

Concrete Precast Treads



- » Will not rust
- » 5000 psi concrete
- » Reinforced with #3 rebar gr. 40
- » Overall thickness is 2-1/4"
- » Light to medium broom finish with a 2" edging and 3/8" radius
- » Treads are sloped with an 85° angle
- » Live load of 100 lbs. per sq. Ft.
- » Lip Tread Design reduces gap without extra components
- » Overall thickness is 2-1/4"
- » Front lip tread is 3-3/8" tall and 1" deep

Standard Concrete Steps

- » For standard installations

ITEM #	SIZE
STBF1136	11" x 36"
STBF1236	12" x 36"
STBF1140	11" x 39 1/2"
STBF1240	12" x 39 1/2"
STBF1142	11" x 42"
STBF1242	12" x 42"
STBF1248	12" x 48"

Lip Tread Concrete Steps

ITEM #	SIZE
STBF1236LP	12" x 36"
STBF1240LP	12" x 39-1/2"
STBF1242LP	12" x 42"



Do not apply salt or any type of chloride product on precast concrete steps to melt ice. Salt will rapidly deteriorate the step.

Formed Steel Stair Stringer

- » Roll formed from sturdy 12 gauge plate
- » Stocked in 20' lengths

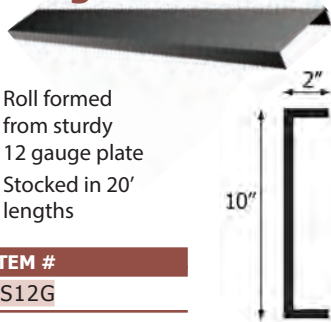

ITEM #
SS12G

Flex-Tred Anti-Slip



- » Anti-slip safety rolls for indoor or outdoor use
- » Easy to install adhesive backing. Just cut, place and press.

ITEM #	SIZE
STF1	1" x 60 ft. Anti-Slip Roll
STF2	2" x 60 ft. Anti-Slip Roll
STF4	4" x 60 ft. Anti-Slip Roll
STF6	6" x 60 ft. Anti-Slip Roll

Steel Tread Angle



4 Holes

- » For mounting concrete steps to stair stringers

ITEM #	SIZE
STTA	3" x 2" x 3/16" x 8" long

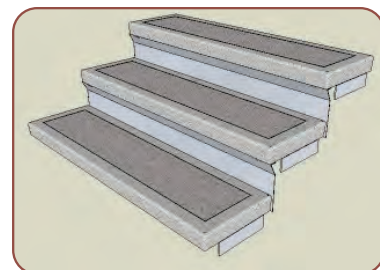

Black Painted Closed Riser Attachments for Concrete Steps

- » Easy bolt-on assembly with tread

ITEM #	DIMENSIONS
STCR36	7-1/4" high x 36" wide
STCR39	7-1/4" high x 39-1/2" wide
STCR42	7-1/4" high x 42" wide

Stock Steel Pan Type

Stock Sizes Ready to Ship

» Ready to weld and add concrete

A - Made from 16 gauge steel plate

ITEM #	SIZE	DESCRIPTION
STSP36	11" x 36"	2" High, 1/2" Lip
STSP40	11" x 40"	2" High, 1/2" Lip
STSP42	11" x 42"	2" High, 1/2" Lip



Stock Steel Diamond Floor Plate

Stock Sizes Ready to Ship

B - Made from 1/8" thick diamond steel floor plate

ITEM #	SIZE	DESCRIPTION
STSP36F	11"x36"	2" Lip Down, 1" Lip Up
STSP40F	11"x40"	2" Lip Down, 1" Lip Up
STSP42F	11"x42"	2" Lip Down, 1" Lip Up

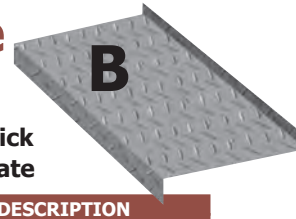

Custom Made Stair Step Risers Let Us Make Them for You!

- » Smooth sheet metal
- » Material available: 16 ga., 14 ga., or 11 ga. steel



For Custom Stairs

Contact Us with the Below Information, which You Can

Custom Made Stair Step Riser Work Sheet

Choose Style: 1 2 3

Material Thickness: _____

Length: _____

Quantity: _____

DIMENSIONS

A: _____

B: _____

C: _____

D: _____

Custom Diamond Steel Floor Plate Stair Steps

» Material: 1/8" diamond steel floor plate

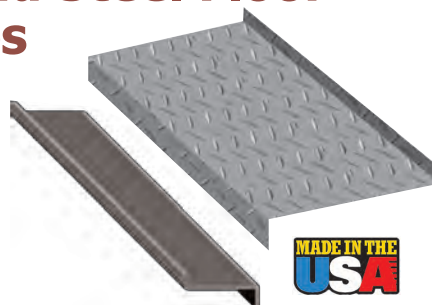
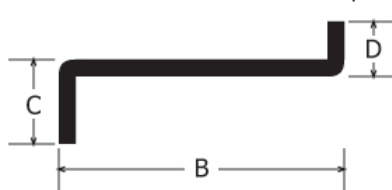

Diamond Plate Stair Step Work Sheet

Material Thickness: _____

Length: _____ Quantity: _____

DIMENSIONS

B: _____

C: _____

D: _____

U-Edging *Versatile U-Edging Provides a Finished Look as Well as a Protective Barrier from Sharp Edges*

18 ga Cold Rolled Steel

12 FT Length

1" O.D. Legs

Weld On

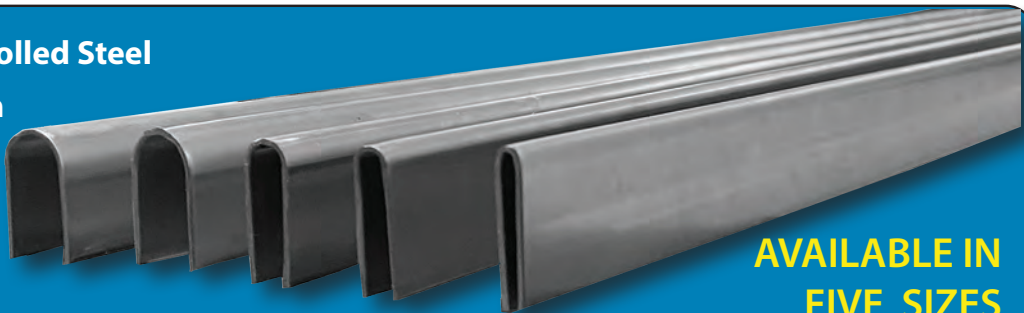

AVAILABLE IN FIVE SIZES

Find a Large Selection of Wire Mesh Panels & Perforated Metal Screening on Pages 2-5

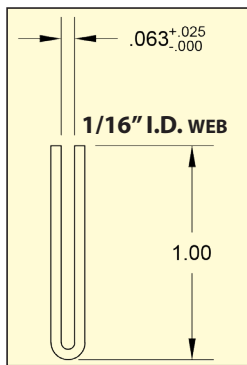

MCTR300

Easily attaches to perforated sheets or smooth, flat sheets (16ga - 24ga) as well as all #16 flat expanded metal for a finished, attractive look.

ITEM #
MCTR300

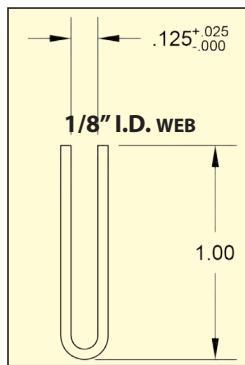

MCTR400

Seals the edges of any #9 flat expanded metal.

The U-Edging piece will also frame the cut ends of our 10ga wire mesh panels.

ITEM #
MCTR400

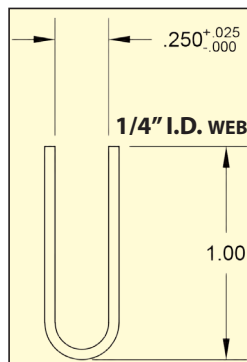
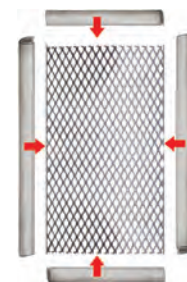

MCTR500

Trims out our FRZ series of 10ga wire mesh panels that can be used for numerous applications.

ITEM #
MCTR500

U-Edging is Versatile Accessory that Works Well for These Applications & Numerous Others:

- Expanded & Perforated Metal Enclosure
- Frame Wire Meshing
- Handrail Filler Panels
- Wire Screening
- Shelving Edge

Painted U-edging forms an attractive border for these wire mesh panels

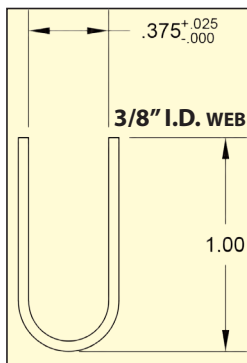

MCTR600

Forms an edge for #6 ga wire panels as well as #9 standard expanded metal.

ITEM #
MCTR600

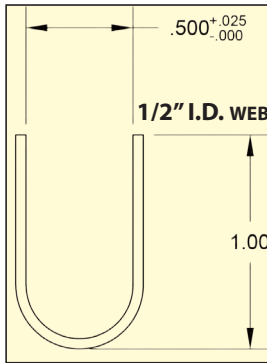

MCTR700

Create a border for panels consisting of two #4 ga wires or #6 standard expanded metal.

ITEM #
MCTR700

Provides a polished, defined look by framing the wire mesh panels

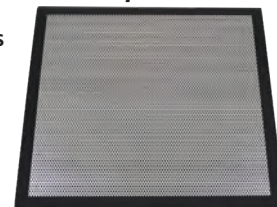

Four Sided Hammered Tubes

20' length tube
Square or Rectangular

Due to item length & potential damage during shipping, we offer a **FREE** service to cut item into smaller sections for the most efficient shipping.

Requested cutting for in store purchases will be charged a small cutting fee.

ITEM#	GAUGE	DIMENSIONS	WEIGHT
SF137419	16g	1/2" square	8 lbs.
SF137420	14g	5/8" square	12 lbs.
SF118E1	14g	3/4" square	14 lbs.
SF118E9	14g	1" square	20 lbs.
SF118E3	14g	1-1/4" square	24 lbs.
SF118E5	14g	1-1/2" square	30 lbs.
SF137415	14g	2" square	39 lbs.
SF137416	14g	3" square	62 lbs.
SF137417	14g	4" square	83 lbs.
SF118E6	14g	2" x 1" rectangle	29 lbs.



Four Sided Hammered Square Bars

Hammered on 4 Edges the Entire Length of Bar

20' Approximate Length

Due to item length & potential damage during shipping, we offer a **FREE** service to cut item into smaller sections for the most efficient shipping.

Requested cutting for in store purchases will be charged a small cutting fee.

ITEM#	SIZE	WEIGHT
SF125F	1/2" sq.	13.9 lbs.
SF916F	9/16" sq.	17.9 lbs.
SF585F	5/8" sq.	26.6 lbs.
SF345F	3/4" sq.	41.5 lbs.
SF15F	1" sq.	65.0 lbs.





Shown Here is
Mechanically
Hammered
Round Bar

Mechanically Hammered Round Bar

10' Approximate Length

Good Match for Forged Round Pickets

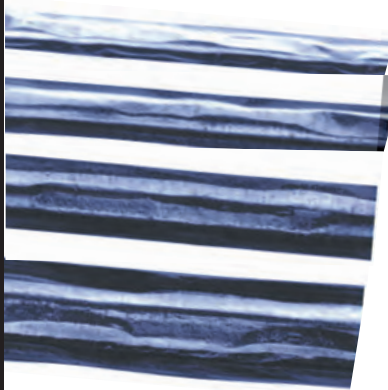

ITEM#	DIA.	WEIGHT
SF516TB	5/16"	2.5 lbs.
SF34TB	3/4"	12.8 lbs.

ITEM#	DIA.	WEIGHT
SF38TB	3/8"	4 lbs.
SF78TB	7/8"	18.9 lbs.

ITEM#	DIA.	WEIGHT
SF14TB	1/4"	2.0 lbs.
SF12TB	1/2"	5.8 lbs.

Mechanically Hammered Rectangular Bar

10' Approximate Length

2 Sides Diamond Hammered Profile



ITEM#	SIZE	WEIGHT
SF6231	1/2" x 1/4"	3.3 lbs.

Heavily Hammered Square Bars

Hammered on 4 Corners & Sides Full Length of Bar

10' Approximate Length



ITEM#	SIZE	WEIGHT
SF118A1	1/2" sq.	7.5 lbs.
SF118A2	9/16" sq.	10.2 lbs.

ITEM#	SIZE	WEIGHT
SF118A3	5/8" sq.	13.3 lbs.
SF118A5	3/4" sq.	20.8 lbs.

Grooved & Hammered Long Bars

10' Approximate Length

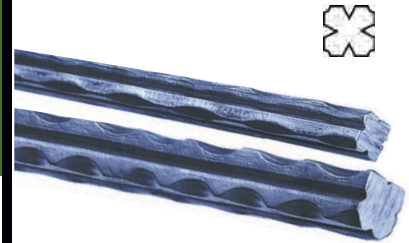

ITEM#	SIZE	WEIGHT
SF6258	1/2" sq.	6.6 lbs.
SF6259	5/8" sq.	12.8 lbs.
SF62510	3/4" sq.	20.9 lbs.

Collar (Banding) Material

13' Approximate Length

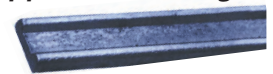

ITEM#	SIZE	WEIGHT
SF1581	9/16" x 5/32"	2.2 lbs.



ITEM#	SIZE	WEIGHT
SF1586	9/16" x 5/32"	3.1 lbs.

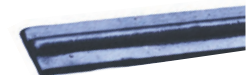

ITEM#	SIZE	WEIGHT
SF1583	9/16" x 5/32"	2.4 lbs.



Pre-Fitted Collars

- » Place around bars and squeeze close
- » No need for cutting



ITEM#	FITS	WEIGHT
SF15815	3 bars of 1/2"x1/4"	.06 lbs.
SF15816	4 bars of 1/2"x1/4"	.07 lbs.

Twisted Steel Bars

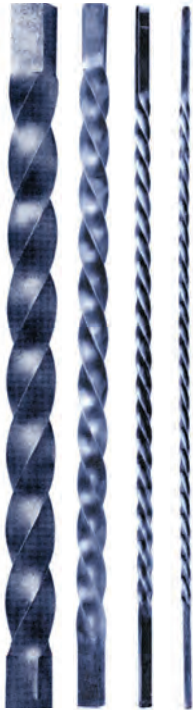

*Custom Manufactured
Other Sizes Available-Please Inquire*

ITEM#	MTL	LENGTH	WT.
SF38365	3/8" sq.	35 1/2"	1.5 lbs
SF3847	3/8" sq.	47"	2 lbs
SF12365	1/2" sq.	35 1/2"	2.5 lbs
SF1247	1/2" sq.	47"	3.3 lbs
SF58365	5/8" sq.	35 1/2"	3.9 lbs
SF5847	5/8" sq.	47"	5.2 lbs
SF34365	3/4" sq.	35 1/2"	5.6 lbs
SF3447	3/4" sq.	47"	7.4 lbs
SF118H25	1" sq.	118"	34 lbs

20' Long Stock twisted Bars

SF38T	3/8" sq.	20'	10 lbs
SF12T	1/2" sq.	20'	17 lbs
SF58240	5/8" sq.	20'	26.5 lbs
SF34240	3/4" sq.	20'	38 lbs

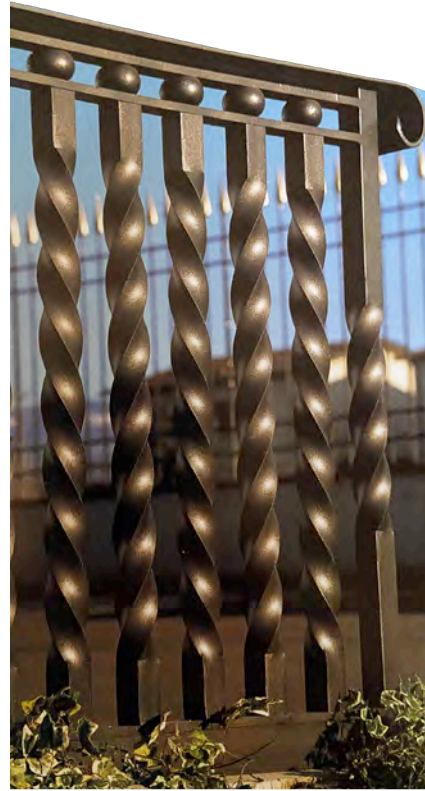

1/2" Square Solid Pickets with Twist Pattern

*Custom Lengths Available -
Please Inquire*

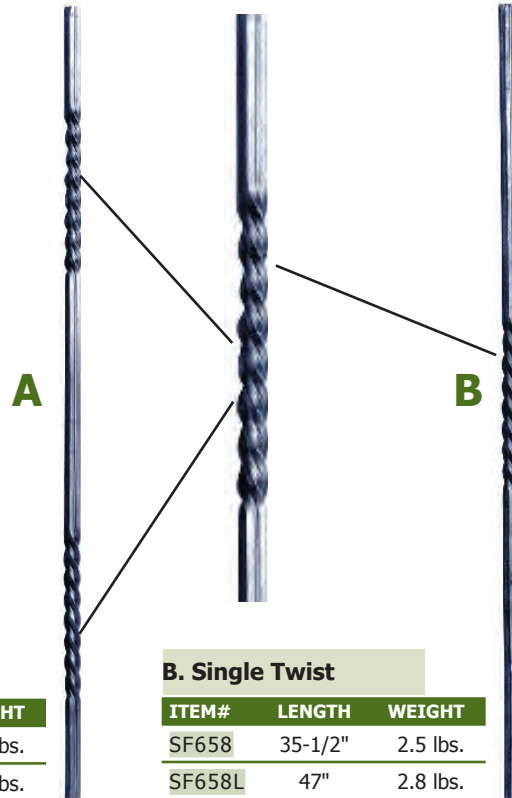

A. Double Twist

ITEM#	LENGTH	WEIGHT
SF533	35-1/2"	2.5 lbs.
SF533L	47"	2.8 lbs.

B. Single Twist

ITEM#	LENGTH	WEIGHT
SF658	35-1/2"	2.5 lbs.
SF658L	47"	2.8 lbs.

Heavy Section Twists



39 3/8" L
Wt. 31.1 lbs.

Mtl 2 3/8" x 1- 3/16"

ITEM#
SF172413

47 1/4" L
Wt. 52 lbs.

Mtl 2"

ITEM#
SF172428

Twisted Round Bar Rope

106" Approximate Length (8.83 FT)



ITEM#

SF1191

rope
Mtl 5/8" dia.
Wt. 7 lbs.

ITEM#

SF1192

rope
Mtl 3/4" dia.
Wt. 12 lbs.

ITEM#

SF1193

rope
Mtl 1-3/16" dia.
Wt. 25 lbs.

Twisted "Rope Style" Quad Bar

10' Approximate Length



ITEM#

SF6263

Mtl 1/2" dia.
Wt. 8 lbs.

ITEM#

SF6265

Mtl 5/8" dia.
Wt. 11 lbs.

ITEM#

SF6269

Mtl 1" dia.
Wt. 37.4 lbs.

"ECONOMICAL"

Decorative Quad Bar



10' Approximate Length

ITEM#

SF62614

MATERIAL

3/4"

WEIGHT

22.1 lbs

Hammered Flat Bars

10' Approximate Length

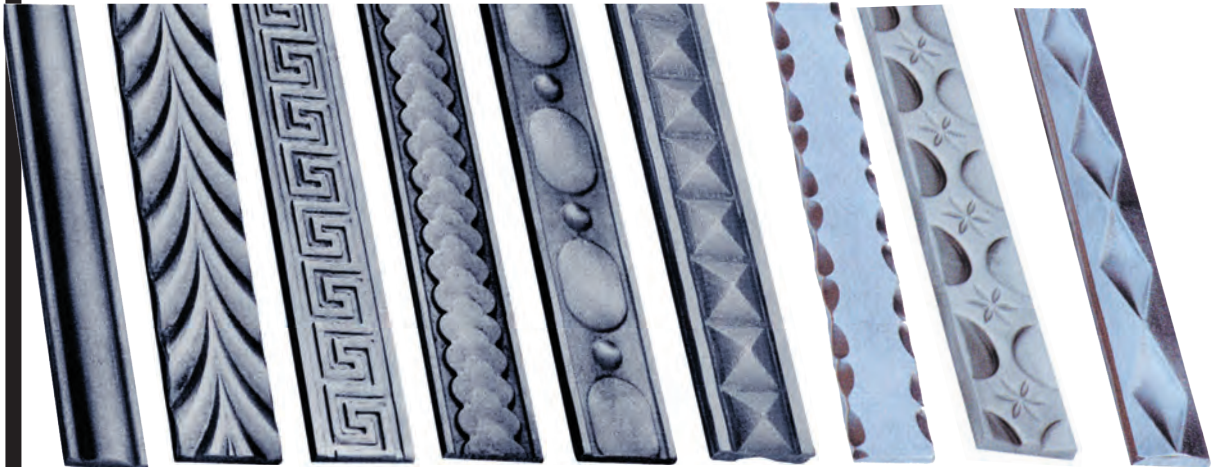

ITEM#

SF91601

Mtl 1-3/16"
x 1/4"
Wt. 3.5 lbs.

ITEM#

SF91602

Mtl 1-1/4"
x 3/16"
Wt. 6.3 lbs.

ITEM#

SF91603

Mtl 1-1/4"
x 3/16"
Wt. 5.9 lbs.

ITEM#

SF91604

Mtl 1-1/4"
x 3/16"
Wt. 5.9 lbs.

ITEM#

SF91605

Mtl 1-1/4"
x 3/16"
Wt. 5.9 lbs.

ITEM#

SF91606

Mtl 1-1/4"
x 3/8"
Wt. 6.6 lbs.

ITEM#

SF18347

Mtl 1-1/4"
x 1/4"
Wt. 9.7 lbs

ITEM#

SF18349

Mtl 1-1/4"
x 1/4"
Wt. 8.4

ITEM#

SF18348

Mtl 1-1/4"
x 3/8"
Wt. 12.7

Plain Round Hot Pierced Bars



Insert standard round bar

Bars with 4-1/2" pitch meet US 4" spacing code

ITEM #	MATERIAL	PITCH	HOLE SIZE	NO. OF HOLES	LENGTH	WEIGHT
SF422US	5/8" Round	4-1/2"	5/8" Round	17	78-3/4"	7 lbs.
SF424	3/4" Round	6-3/4"	3/4" Round	11	78-3/4"	11 lbs.

Plain Square Hot Pierced Bars



Insert standard square bar

Bars with 4-1/2" pitch meet US 4" spacing code

ITEM #	MATERIAL	PITCH	HOLE SIZE	NO. OF HOLES	LENGTH	WEIGHT
SF429US	5/8" Square	4-1/2"	5/8" Square	17	78-3/4"	8.9 lbs.
SF4210	3/4" Square	6-5/16"	3/4" Square	12	78-3/4"	11 lbs.

Plain Diamond Hot Pierced Bars



Insert standard square bar

ITEM #	MATERIAL	PITCH	HOLE SIZE	NO. OF HOLES	LENGTH	WEIGHT
SF4224	3/4" Square	6-5/16"	11/16" Diamond	12	78-3/4"	11 lbs.

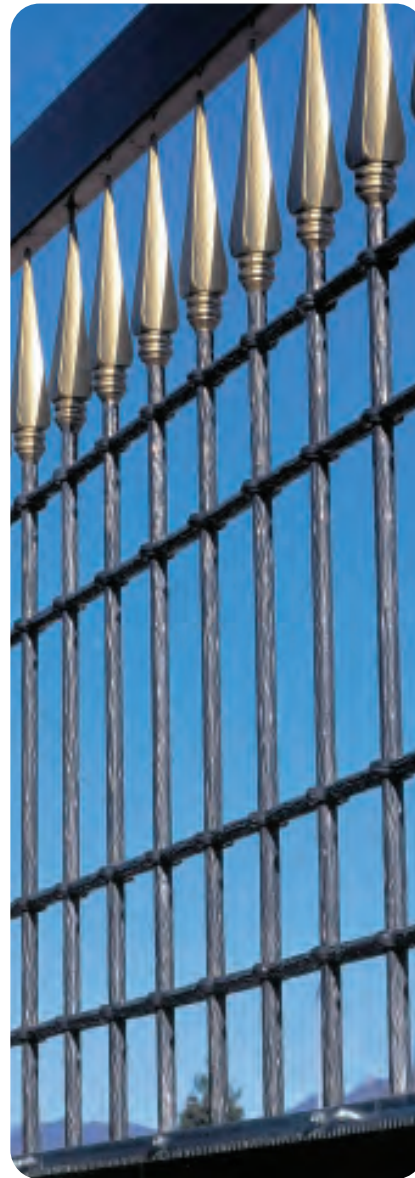

TREE BARK ROUND BARS



Tree Bark Style Square Bar

10 ft. length

ITEM #	SIZE	LENGTH	WEIGHT
SF6235	1/2" Square	10 ft.	7.5 lbs.
SF6236	9/16" Square	10 ft.	10.2 lbs.
SF6237	5/8" Square	10 ft.	13.3 lbs.
SF6239	3/4" Square	10 ft.	20.7 lbs.

Tree Bark Style Round Bar

10 ft. length

ITEM #	SIZE	LENGTH	WEIGHT
SF5991	5/16" Round	10 ft.	2.5 lbs.
SF5992	3/8" Round	10 ft.	4 lbs.
SF5993	1/2" Round	10 ft.	7 lbs.
SF5994	9/16" Round	10 ft.	8 lbs.
SF5995	5/8" Round	10 ft.	11 lbs.
SF5997	3/4" Round	10 ft.	15.9 lbs.

For Use w/Standard Style For Use w/Extra Wide Style

Steel Handrails

Standard Style

- » 20 ft. length
- » Fits 1" channel or tubing
- » Commercial mild steel
- » Weighs 25.4 lbs.

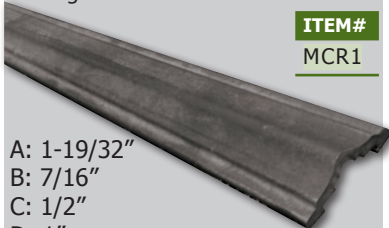

ITEM #
MCR1

A: 1-19/32"
B: 7/16"
C: 1/2"
D: 1"

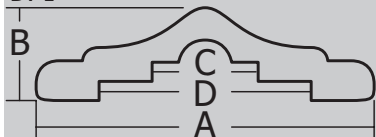

Steel Handrails

Extra Wide Style

- » 20 ft. length
- » Wide series for 1-1/2" channel, flat or tube
- » Commercial mild steel
- » Weighs 42 lbs.



ITEM #
MCR112

A: 2-1/8"
B: 3/4"
C: 1-1/4"
D: 1-1/2"

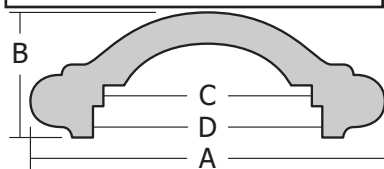

Cast Iron Square Terminal End

- » Length: 3-1/2"
- » Overall Width: 2-1/8"

ITEM #	HANDRAIL	WIDTH	WEIGHT
CI7053	MCR1	1-19/32"	1 lb.

Cast Iron Left Channel

For MCR1 Standard and MCR112 Extra-Wide Steel Handrails

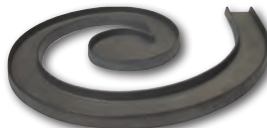

- » Attach to laterals shown below to create ends for handrail runs
- » Ductile iron channels can withstand up to 30° cold bend

ITEM #	HANDRAIL	CHANNEL	MATERIAL
CI75LCS	MCR1	1"	Cast Iron
CI401HL	MCR1	1"	Ductile Iron
CI75LCW	MCR112	1-1/2"	Cast Iron

Cast Iron Left Lateral

For MCR1 Standard and MCR112 Extra-Wide Steel Handrails



- » Attach to channels shown above to create ends for handrail runs
- » Ductile iron channels can withstand up to 30° cold bend

ITEM #	HANDRAIL	CHANNEL	MATERIAL
CI55LLS	MCR1	1"	Cast Iron
CI400HL	MCR1	1"	Ductile Iron
CI55LLW	MCR112	1-1/2"	Cast Iron

Laterals and Channels

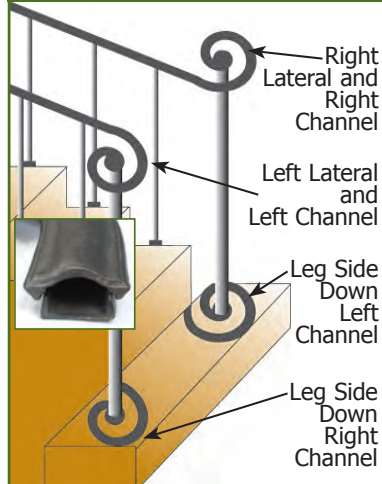

Cast Iron Right Channel

For MCR1 Standard and MCR112 Extra-Wide Steel Handrails

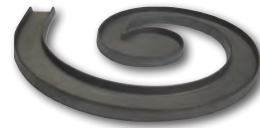

- » Attach to laterals shown below to create ends for handrail runs
- » Ductile iron channels can withstand up to 30° cold bend

ITEM #	HANDRAIL	CHANNEL	MATERIAL
CI75RCS	MCR1	1"	Cast Iron
CI401HR	MCR1	1"	Ductile Iron
CI75RCW	MCR112	1-1/2"	Cast Iron

Cast Iron Right Lateral

For MCR1 Standard and MCR112 Extra-Wide Steel Handrails



- » Attach to channels shown above to create ends for handrail runs
- » Ductile iron channels can withstand up to 30° cold bend

ITEM #	HANDRAIL	CHANNEL	MATERIAL
CI55RLS	MCR1	1"	Cast Iron
CI400HR	MCR1	1"	Ductile Iron
CI55RLW	MCR112	1-1/2"	Cast Iron

Cast Iron Volute Handrail End

- » For straight or angled runs

ITEM #	HANDRAIL	CHANNEL	WIDTH
CI4X	MCR1	1"	1-19/32"
CI4X112	MCR112	1-1/2"	2-1/8"

Steel Curled Handrail End

- » For straight or angle runs
- » Length: 5-7/8"
- » Height: 11-13/16"

ITEM #	HANDRAIL	WIDTH	WEIGHT
SF81212	MCR112	2-1/8"	3.9 lbs.

Steel

Lamb's Tongue Handrail End

- » For straight or angle runs
- » Length: 5-7/8"
- » Height: 13-3/4"

ITEM #	HANDRAIL	WIDTH	WEIGHT
SF137741	MCR1	1-19/32"	3 lbs.
SF137740	MCR112	2-1/8"	3.8 lbs.

Steel Handrail

Forged

Mtl 2 9/32" x 9/16"
L 78 3/4"

ITEM#
SF1141

Forged

Mtl 2 9/32" x 9/16"
L 78 3/4"

ITEM#
SF1142

Mtl 1 7/8" x 5/8"
L 10' Approx

ITEM#
SF114A3

Cast Iron

Lamb's Tongue Handrail End

For Straight Runs

ITEM #	HANDRAIL	CHANNEL	WIDTH
CI5	MCR1	1"	1-19/32"
CI5112	MCR112	1-1/2"	2-1/8"

Mtl 1 9/16" x 5/16"
L 10' Approx

ITEM#
SF1144

Mtl 1-9/16" x 5/16"
L 10' Approx

ITEM#
SF1148

Mtl 1 9/16" x 5/16"
L 10' Approx

ITEM#
SF1145

Mtl 1 3/16" x 5/16"
L 10' Approx

ITEM#
SF1149

Cast Iron

Lamb's Tongue Handrail End

For Angled Runs

ITEM #	HANDRAIL	CHANNEL	WIDTH
CI6	MCR1	1"	1-19/32"
CI6112	MCR112	1-1/2"	2-1/8"

Steel Handrail End Pieces

ITEM#
SF1151
Use with Handrail SF1141

ITEM#
SF1152
Use with Handrail SF1142

ITEM#
SF114B14
Use with Handrail SF114A3

ITEM#
SF114B13
Use with Handrail SF114A3

ITEM#
SF114B4
Use with Handrail SF1144

ITEM#
SF114B8
Use with Handrail SF1148

ITEM#
SF114B5
Use with Handrail SF1145

ITEM#
SF11610
Use with Handrail SF1145
See Handrails Above for Pattern

ITEM#
SF11613
Use with Handrail SF1148

ITEM#
SF1169
Use with Handrail SF1144

90° Bend Handrail

ITEM# Wt.
SF11625 3.7 lbs.
Matches SF1144

ITEM# Wt.
SF11626 3.7 lbs.
Matches SF1145

ITEM# Wt.
SF11629 3.7 lbs.
Matches SF1148

See Pages
80-81 for
More
Handrail
Brackets

Steel Tubular Handrail

14 Gauge

- » Conforms to conventional 1-3/4" wide molded cover rail combined w/ 1" channel
- » 1" H x 1-3/4" W x 20 ft L

ITEM#

MCRMTH1420

Cast Iron Straight

- » Height: 4-3/8"
- » Width: 1-3/4"
- » Length: 2-5/8"

ITEM#

CI902

Cast Iron Beveled

- » Height: 3-1/4"
- » Width: 1-3/4"
- » Length: 3-1/2"

ITEM#

CI901

Rail End Plug

- » Height: 1"
- » Width: 1-3/4"
- » Length: 2-1/8"

ITEM#

CI7058

For Use with Molded Cover Rail & Tubular Handrail

- » Height: 3-3/4"
- » Width: 2-1/2"

ITEM#

CI654

Cast Iron Volute

- » Height: 2-1/2"
- » Width: 1-3/4"
- » Length: 3"

ITEM#

CI900

Steel Bracket

- » Heavy Duty
- » 3/16" thick
- » 2-3/4" round base
- » 4-1/2" overall height
- » 1/2" wall mounting hole
- » Two 1/4" rail mounting holes
- » 3" from wall to rail center
- » Use with round or square handrail

STEEL

ITEM #

SC35B

Steel Bracket

- » Stamped from 1/8" steel
- » 4" overall height
- » 2-3/4" round base
- » 3/8" wall mounting hole
- » Two 3/16" rail mounting holes
- » 2-5/8" from wall to rail center
- » Use with round pipe handrail

STEEL

ITEM #

SC35BRP

Cast Iron Bracket

- » 2-3/4" round base
- » 3-3/4" overall height
- » 3/8" wall mounting hole
- » Two 3/16" rail mounting holes
- » 2-3/8" from wall to rail center
- » Use with flat or square handrail

CAST IRON

ITEM #

CI3A



STEEL

Mtl 1-5/16"
5/16" - 1/2"

ITEM#

CI14051



STEEL

Mtl 6-5/16"
x 3-23/32"

ITEM#

CI94A1



STEEL

Mtl 3-5/32"
5/16" - 1/2"

ITEM#

CI14052



Round

STEEL

Mtl 3-5/32"
5/16" - 5/8"

ITEM#

CI14053



CAST IRON

3-3/4" x 3-1/4"
Extends 3-1/2" from wall

ITEM#

CI3HRB



CAST IRON

For square tubing
Extends 2-3/8" from wall

ITEM#

CI9002

Aluminum Molded Volute

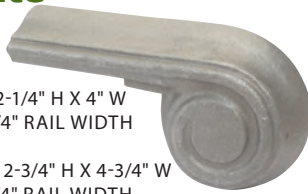

AC4X: 2-1/4" H X 4" W
FOR 1-3/4" RAIL WIDTH

AC4XW: 2-3/4" H X 4-3/4" W
FOR 2-1/4" RAIL WIDTH

ITEM#	
AC4X	Use with 1 3/4" Wide Rail
AC4XW	Use with 2 1/4" Wide Rail

Aluminum Straight Lambs Tongue



AC5XL: 4-1/2" H X 4" W
FOR USE ON 1-3/4" RAIL

AC5XLW: 5-1/4" H X 5" W
FOR USE ON 2-1/4" RAIL

ITEM#	
AC5XL	Use with 1 3/4" Wide Rail
AC5XLW	Use with 2 1/4" Wide Rail

Aluminum Beveled Lambs Tongue



AC6XL: 4-1/2" H X 4" W
FOR USE ON 1-3/4" RAIL

AC6XLW: 5-1/4" H X 5" W
FOR USE ON 2-1/4" RAIL

ITEM#	
AC6XL	Use with 1 3/4" Wide Rail
AC6XLW	Use with 2 1/4" Wide Rail

Aluminum Handrail

Two Widths Available

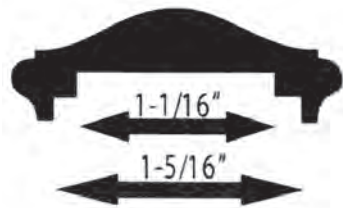

1-3/4" Wide

ITEM#	
MCR1AL20	1-3/4" Wide



2 1/4" Wide

ITEM#	
MCR112AL20	2-1/4" Wide

Extruded Aluminum Handrail Bracket



- » Matte finish
- » Saddle fits 1.50" thru 3.00" OD and flat surfaces
- » Meets codes requiring a 1-1/2" minimum clearance between handrail and wall as well as under side of handrail and horizontal bracket arm

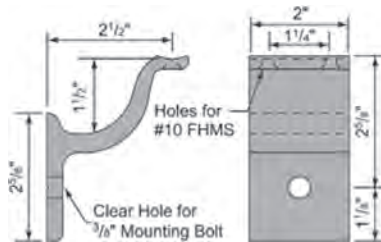

ITEM #	WALL OFFSET	BASE SIZE
SCAL8103	2-1/2"	2" x 2-5/8"

Aluminum Spear



4-1/4" Tall

ITEM#	SQ. SIZE	TYPE
AC649AL	1/2"	Aluminum
AC64958AL	5/8"	Aluminum
AC649SAL	3/4"	Aluminum

Aluminum Ball Point Spears

3-7/8" Tall

- » Four flute design

ITEM#	FITS
AC9XAL	1/2"
AC9X34AL	3/4"



Aluminum Post Caps

Find Additional Aluminum Post Caps on Page 78

ITEM#	SIZE
AC807AL	2" x 2"
AC808AL	3" x 3"
AC809AL	4" x 4"

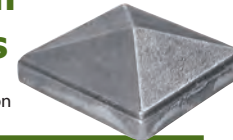

Aluminum Baluster Collars



ITEM#	SQ. SIZE	TYPE
AC68312AL	1/2"	Aluminum
AC68358AL	5/8"	Aluminum
AC68334AL	3/4"	Aluminum

Aluminum Newell Post Balls

ITEM#	SQUARE SIZE
AC118AL	2"
AC120AL	3"
AC119AL	4"



Plastic Ball Newel Post Caps

PLASTIC

- » Easy to install
- » No painting necessary
- » Economically priced



ITEM #	POST SIZE	COLOR
PS118B	2" x 2"	Black

Plastic Finial

PLASTIC

Black

1"

Width: 1-1/16"
Height: 2-1/2"
Fits over 1/2" square pickets

1/2"

Also fits into 1" square tubing
16 ga.



ITEM #

PSM50

Plastic Finial

PLASTIC

Black

1"

Width: 3 3/8"
Height: 5 1/2"

3/4"

1/2"

PSM40 fits over 1/2" Sq or inside of 1" X 16GA Sq

PSM656 fits over 3/4" Sq

ITEM# DESCRIPTION

PSM40 Fits over 1/2"sq. or inside of 1" sq

PSM656 Fits over 3/4" sq



Plastic Finial



PLASTIC

Width 2 1/4"
Height 4 3/8"



ITEM# PICKET SIZE COLOR

PSM25	1/2"	Black
PSM25W	1/2"	White
PSM2558	5/8"	Black
PSM2534W	3/4"	White
PSM2534	3/4"	Black

Plastic Finial

PLASTIC

Width 1 1/2"
Height 4 1/4"



ITEM# PICKET SIZE COLOR

PSM30	1/2"	Black
PSM30W	1/2"	White
PSM3058	5/8"	Black
PSM34	3/4"	Black
PSM34W	3/4"	White

Plastic Newel Post Caps

PLASTIC

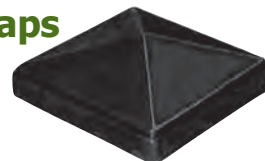

ITEM#	POST SIZE	COLOR
PS807B	2" x 2"	Black
PS807W	2" x 2"	White
PS808B	3" x 3"	Black
PS808W	3" x 3"	White

Plastic Scroll

PLASTIC

W 6 1/2"
H 12 1/2"
Fits 1/2" Pickets

ITEM#

PS3



PLASTIC

W 4"
H 3"
Fits 1/2" Sq

ITEM#

PS10A



With Steel Welding Tabs

PLASTIC

W 7 1/2"
H 16 1/2"
Fits 1/2" Pickets

ITEM#

PS2



Actual dimensions may vary slightly due to variations in manufacturer's production.

Most Popular

1/2"

4 1/4" High
Fits 1/2" Square

ITEM#
CI9X

5/8"

4 1/4" High
Fits 5/8" Square

ITEM#
CI9X58

3/4"

4 1/4" High
Fits 3/4" Square

ITEM#
CI9X34

3/4"

Extra Large
6" High
Fits 3/4" Square

ITEM#
CI9Y

1"

8" High
Fits over 1" Square

ITEM#
CI9Z

1 1/4"

6" H x 2" W
Base 2 1/8" Square
Fits 1 1/4" Square

ITEM#
CI9XL114



1"

4" High
1 3/8" W
5/8" Deep shaft
Plugs into 1"

ITEM#
CI9C



3"

7 1/2" High
Base 3 1/4" sq.
3 lbs

ITEM#
CI9324



1/2"

4 1/4" High
Fits 1/2" Square

ITEM#
CI9A



1/2"

4-1/8" H
7/8" Base Width
Fits 1/2" Square

ITEM#
CI649

5/8"

4-1/2" H
Fits 5/8" Square

ITEM#
CI64958

3/4"

4-1/2" H
Fits 3/4" Square

ITEM#
CI649S

3/4"

5-1/2" H
Fits 3/4" Square

ITEM#
CI64934

1"

3-1/4" W
6-1/4" H
Fits 1" Square

ITEM#
CI8025

1 1/2"

5-3/4" W
9" H
2-1/4" Base Width
Fits 1 1/2" Square

ITEM#
CI649ZXL



1"

Height 4 1/2".
1" square base.

Plugs into 1" square tube

ITEM#
CI649X



1/2"

2 5/8" W
4 3/4" H
Fits over 1/2" sq.
Base 1 1/8" sq. OD
.5 lbs

ITEM#
CI865



3/4"

3 1/2" W
6 3/4" H Base
1 3/16" sq. OD
3/4" sq. ID
1 lbs

ITEM#
CI8804



CAST IRON FINIALS

Actual dimensions may vary slightly due to variations in manufacturer's production.

4"



6" W
9 1/4" H
Base 4"x4"
5.25 lbs

ITEM#

CI8805FB

1/2"

3/4"

2 3/4" W
6" H
Fits 1/2" Sq

ITEM#

CI66

2 3/4" W
6" H
Fits 3/4" Sq

ITEM#

CI6634



1/2"



2 1/2" W
4 1/2" H
Fits 1/2" Square

ITEM#

CI66XS

3/4"



5 3/4" H
3/4" sq.
Fits 3/4" Square

ITEM#

CI86434

1"



4 1/2" W
6 5/8" H
Plugs into 1" square tube

ITEM#

CI864

1/2"



2 1/2" W x
4 5/16" H
Fits 1/2" Square

ITEM#

CI656XS

1/2"

5/8"

3/4"

3/4"

5-1/4" High
3-3/8" Wide
Fits 1/2" Sq.
Wt: 0.5 lbs.

ITEM#

CI656

5" High
3-1/4" Wide
Fits 5/8" Sq.
Wt: 0.4 lbs.

ITEM#

CI7065

5-1/2" High
3-1/4" Wide
Fits 3/4" Sq.
Wt: 0.46 lbs.

ITEM#

CI65634YS

6-7/8" High
4-1/8" Wide
Fits 3/4" Sq.
Wt: 1.0 lbs.

ITEM#

CI65634



5/8"



5 3/4" H
Fits 5/8" Sq.

ITEM#

CI8005

1/2"

3/4"

1"

2 5/8" W
4 5/8" H
Fits over 1/2"sq.
Base 1-1/4" OD .5 lb

ITEM#

CI8832

3 1/8" W
5 1/4" H
Fits over 3/4"sq.
Base 1-1/4" sq. OD 1 lb

ITEM#

CI8832Y

4 1/2" W
7 5/8" H
Fits over 1"sq.
Base 1 1/2" sq. OD 2.25 lbs.

ITEM#

CI8832Z



1/2"



2-3/4" Wide
4-3/4" High
Fits 1/2" Square

ITEM#

CI7075

Actual dimensions may vary slightly due to variations in manufacturer's production.

5/8"

3" W
5-1/2" H
Fits over
5/8" sq.

ITEM#
CI880258

3/4"

2-15/16" W
5-1/4" H
Fits over
3/4" sq.

ITEM#
CI880234

1"

5-1/2" W
9-1/2" H
Fits over
1" sq.

ITEM#
CI8802



1"

3" W
7-1/4" High
Fits over 1" sq.
OD 1/2" sq. ID
Weight: .75 lb

ITEM#
CI668



1/2"

2-1/2" W
4" H
Base 1-1/8" sq.
Fits 1/2" sq.
.5 lbs

ITEM#
CI8821

5/8"

3" W
5" H
Base 1-3/16" sq.
Fits 5/8" sq.
.75 lbs

ITEM#
CI8858

3/4"

3-1/2" W
6" H
Base 1-1/2" sq.
Fits 3/4" sq.
1.25 lbs

ITEM#
CI8020



1/2"

4-1/2" H
Fits 1/2" Square

ITEM#
CI667

3/4"

4" H
Fits 3/4" Square

ITEM#
CI21834



1/2"

2-1/4" W
4-3/4" H
Fits 1/2" Square

ITEM#
CI659

5/8"

3-1/4" W
5-1/4" H
Fits 5/8" Square

ITEM#
CI7085

3/4"

3" W
4-3/4" H
Fits 3/4" Square

ITEM#
CI7090



3/4"

4" Wide
7" High
Fits 3/4" Square

ITEM#
CI7095



1/2"

2-1/2" Wide
4-5/8" High
Fits 1/2" Square

ITEM#
CI7080

3/4"

3-3/4" Wide
6-5/8" High
Base 2"
round OD
Fits 3/4" Square

ITEM#
CI853Y



CAST IRON FINIALS

Actual dimensions may vary slightly due to variations in manufacturer's production.

1/2"

3/4"



4 7/8" H
Fits 1/2" Sq.

5" H
Fits 3/4" Sq.

ITEM#

CI65912S

ITEM#

CI65934S

1/2"

3/4"



3 1/2" W x
6 1/2" H

3-3/8" W x
6 1/2" H

Fits 1/2" Sq.

Fits 3/4" Sq.

ITEM#

CI655

ITEM#

CI601334

1"



4 Sided arrow point
4 1/4" H
Plug 1" sq. x 1" deep
.75 lbs

ITEM#

CI661

3/4"

1"



5" High
2" Wide
4 Sided Spire
Fits 3/4" Sq.

8" High
1-1/2" Wide
4 Sided Spire
Fits 1" Sq.

ITEM#

CI671

ITEM#

CI671XL

3/4"



1" W x 4 5/8" H
Fits 3/4" Square

ITEM#

CI954

1"



4 1/4" H
Base 1-1/4" sq. OD
Plug 1" sq. x
3/4" Deep
.75 lb

ITEM#

CI9J

1"



3" H
Base 1" sq.
Solid
.5 lb

ITEM#

CI8010

3/4"



2" W x 5" H
Base 1 1/2" round
Fits over 3/4" sq.

ITEM#

CI840YN

1"



8" H
Base 1" sq.
2 lb

ITEM#

CI669

1"



2 3/4" W x 8" H
Fits 1" Square
1.75 lb

ITEM#

CI8015

Actual dimensions may vary slightly due to variations in manufacturer's production.

Horse Head Post Caps



9-1/2" High
7" Wide
Hole base
Fits on top 2" OD
also fits inside 3" ID

ITEM#
CIHRSEHD2



11-3/4" High
8-1/2" Wide
Hole base
Fits on top 4" OD
also fits
inside 4-1/2" ID

ITEM#
CIHRSEHD4

Lemon Drop Top

1"



Plugs into 1"
square tubing.
2" high

ITEM#
CI117

Ball Top

1"



1" diameter.
Plugs into 1" square
tubing
1 1/2" high.

ITEM#
CI7X

Ball Top

1 1/4"



1 1/2" dia.
Drives in 1 1/4" sq.
tubing
3 1/2" high

ITEM#
CI7XL

Ball Top

1 1/2"



1 1/2" diameter
1 1/2" square base
2 1/2" tall

ITEM#
CI116

Ball

Actual dimensions may vary slightly due to variations in manufacturer's production.



1 1/4"

4 1/2" Ball
Fits over
1 1/4" dia.
6 1/2" high
3 1/2" width
7 lbs.

ITEM#
CI9539



1"

3 3/4" Ball
Fits over
1" dia.
5" high
2 3/4" width
4.5 lbs.

ITEM#
CI9538



3/4"

2 3/4" Ball
Fits over
3/4" dia.
4" high
2 1/4" width
2 lbs.

ITEM#
CI9537



1/2"

2 1/8" Ball
Fits over
1/2" dia.
3 1/8" high
1 3/4" width
.95 lbs.

ITEM#
CI9536



1/2"

100 pcs per box
4" High
Fits 1/2" Round

ITEM#
CI9R



4"

Fits over 4"
7 1/4" high
4 5/8" width
6.25 lbs.

ITEM#
CI1404



3"

Fits over 3"
6" high
3 5/8" width
3.25 lbs.

ITEM#
CI1403



2"

Fits over 2"
4 5/8" high
2 7/8" width
1.25 lbs.

ITEM#
CI1402



1 1/2"

Fits over 1 1/2"
3 1/2" high
2" width
.75 lbs.

ITEM#
CI1401



1/2"

100 pcs per box
3 7/8" High
Fits 1/2" Round

ITEM#
CI9RS



Cast Iron Newel Post Balls



Fits Over Post

Cast Iron Newel Post Caps

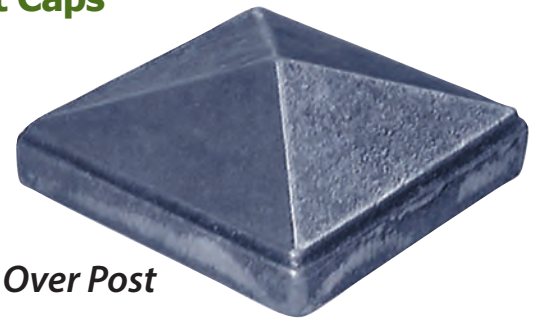

Fits Over Post

See a Number of These Styles in Plastic on Page 100

ITEM#	POST SIZE	HT.
CI108	1"	2-3/4"
CI114	1-1/4"	2-3/4"
CI112	1-1/2"	2-3/4"
CI118	2"	2-3/4"
CI121	2-1/2"	4-1/2"
CI120	3"	5"
CI119	4"	5-1/2"
CI125	5"	6-1/2"
CI126	6"	6-1/2"

ITEM#	POST SIZE
CI805	1" x 1"
CI804	1-1/4" x 1-1/4"
CI806	1-1/2" x 1-1/2"
CI807	2" x 2"
CI8212	2-1/2" x 2-1/2"
CI808	3" x 3"
CI809	4" x 4"
CI810	5" x 5"
CI811	6" x 6"

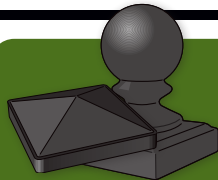

**For More Varieties of Post Caps,
Please See Page 19 & Page 78**

Flat-Top Post Caps



Cap Dimensions Run True to Size

Available in Pressed Steel

» No welding necessary - cap fits tight.

ITEM#	POST SIZE	MATERIAL
SC112FT	1-1/2"	Pressed Steel
SC2FT	2"	Pressed Steel
SC212FT	2-1/2"	Pressed Steel
SC3FT	3"	Pressed Steel
SC4FT	4"	Pressed Steel
SC5FT	5"	Pressed Steel
SC6FT	6"	Pressed Steel
SC8FT	8"	Pressed Steel

Pressed Steel Post Caps

*This Style Also Available in Aluminum or Galvanized
See Page 78 for Complete List of Material and Sizing*



» No welding necessary - cap fits tight.

ITEM#	POST SIZE	MATERIAL
SC114	1-1/4"	Pressed Steel
SC112	1-1/2"	Pressed Steel
SC2	2"	Pressed Steel
SC212	2-1/2"	Pressed Steel
SC3	3"	Pressed Steel
SC4	4"	Pressed Steel
SC5	5"	Pressed Steel
SC6	6"	Pressed Steel
SC8	8"	Pressed Steel



STEEL

Mtl 1/2" sq.
14 1/2" H
Wt. 0.9 lb.

ITEM#

SF88Q2



STEEL

Mtl 1/2" sq.
11 7/16" H
Wt. 0.6 lb.

ITEM#

SF132C12



STEEL

3 35/64" W
6 1/2" H
Wt. 0.3 lb.

ITEM#

SF7515

STEEL

Mtl 1/2" sq.
11 7/16" H
Wt. 0.9 lb.

ITEM#

SF1381N

Crushed Spear Point Curved Pickets

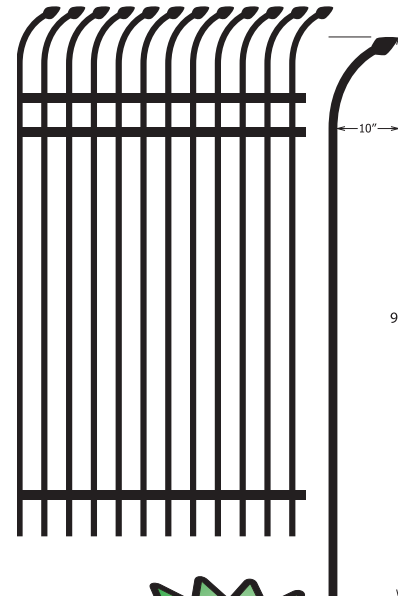

ITEM#	SIZE	FINISH
MCC348BLKARC	3/4" x 92"	Plain
MCC348ARC	3/4" x 92"	Red Primed
MCC348GLVARC	3/4" x 92"	Galvanized

Crushed Steel Spear Point Straight Pickets

- 1/2", 3/4", and 1" Square tube x 16 gauge
- Available in plain, galvanized or red primed finish*
- Two stock lengths and an infinite choice of custom lengths are available

* 1/2" available in plain only

BLACKSMITH BRAND

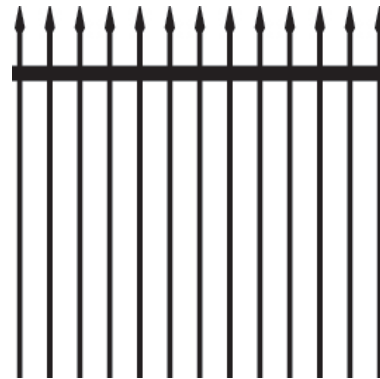

ITEM#	SIZE	FINISH
MCC126BLK	1/2" x 6'	Plain
MCC128BLK	1/2" x 8'	Plain
MCC346BLK	3/4" x 6'	Plain
MCC346	3/4" x 6'	Red Primed
MCC346GLV	3/4" x 6'	Galvanized
MCC348BLK	3/4" x 8'	Plain
MCC348	3/4" x 8'	Red Primed
MCC348GLV	3/4" x 8'	Galvanized
MCC16BLK	1" x 6'	Plain
MCC16	1" x 6'	Red Primed
MCC16GLV	1" x 6'	Galvanized
MCC18BLK	1" x 8'	Plain
MCC18	1" x 8'	Red Primed
MCC18GLV	1" x 8'	Galvanized



STEEL

Mtl 3/8" sq.
H 2 1/8"
Wt. 0.1 lb.

ITEM#

SF894



STEEL

Mtl 1/2" sq.
2 3/4" H
Wt. 0.3 lb.

ITEM#

SF1272



STEEL

3 35/64" W
7 9/32" H
Wt. 0.5 lb.

ITEM#

SF7511



STEEL

Mtl 1/2" sq.
7 7/8" H
Wt. 0.4 lb.

ITEM#

SF1298



STEEL

Mtl 1/2" sq.
7 7/8" H
Wt. 0.4 lb.

ITEM#

SF12912

∅ DENOTES ROUND

Fully Weldable Hand Forged Steel Finials

FORGED STEEL

Base 1" sq.
6-5/16" H
Wt. 0.75 lb.

ITEM#
SF1215



FORGED STEEL

Mtl 1/2" x 1" sq.
1 1/2" W x 4" H
Wt. 0.2 lbs.

ITEM#
SF17961



FORGED STEEL

Base 1-3/8" dia. ∅
7-7/8" H
Wt. 1.4 lbs.

ITEM#
SF185510



FORGED STEEL

Base 1-3/8" dia. ∅
7-7/8" H
Wt. 1.1 lbs.

ITEM#
SF1202



FORGED STEEL

Base 1-3/16" dia. ∅
6-5/8" H
Wt. 0.6 lb.

ITEM#
SF1203



Fully Weldable Hot Stamped Steel Finials

Base 1/2" dia.
5" High

ITEM#
SF1241



STEEL

Base 5/8" dia.
5" High

ITEM#
SF126C7



STEEL

Base 1" sq.
2-1/2" W x 4-5/8" H

ITEM#
SF7279



STEEL

Base 5/8" dia.
2-1/2" x 6-5/8"

ITEM#
SF12613



STEEL

Base 9/16" dia.
6-5/16" High

ITEM#
SF1242



STEEL

Base 1-1/4" dia.
H 4-15/16" H

2-3/8" W
ITEM#
SF138612



STEEL

Base 1-3/8" dia.
7-7/8" High

ITEM#
SF122A1



STEEL

Base 1-3/16" dia.
5" High

ITEM#
SF72711



STEEL

Base 1-3/8" dia.
5" High

ITEM#
SF1251



STEEL

Base 3/8" dia.
5-1/2" High

ITEM#
SF1261



CAST IRON & BRASS ROSETTES & MEDALLIONS

Actual dimensions may vary slightly due to variations in manufacturer's production.

CAST IRON



3-1/2" - Single faced

ITEM#

CI7027

CAST IRON



4" - Double faced

ITEM#

CI7005

CAST IRON



6" dia, 1/2" thick

1" Center hole

Raised star is level with rim

Single faced

ITEM#

CI8609

CAST IRON



4"

Single faced

ITEM#

CI7010

CAST IRON



2-1/2"

Single faced

ITEM#

CI7025

CAST IRON



3-1/8" - Single faced

ITEM#

CI7020

BRASS



Thickness: 5/32"

Diameter: 4-1/2" Single Faced

ITEM #

SF14634



2-7/8" W x 4" H

Single faced

ITEM#

CI84

Pricing Available
By Calling Either
Number
Below

BRASS



Single Faced

ITEM #

SF7074

SIZE

3-11/16"h x 3-1/8"w

Actual dimensions may vary slightly due to variations in manufacturer's production.

CAST IRON

1"

2-1/4" H
1-1/4" W
Base 1" dia Solid
1/2 lb.



ITEM#

CI657XS

CAST IRON

1 3/4"

3-1/2" H
2-1/4" W
Base is 1-3/4"
Round



ITEM#

CI8035

Pineapple

CAST IRON

1 3/4"

4-3/8" Tall
1-3/4" Round Base



ITEM#

CI657

Pineapple Point



CAST IRON

4"

6" H
4" Sq.

ITEM#

CI6059



CAST IRON

2"

7-3/4" H
Base 2" dia Solid
Pineapple-
4-1/4" H x 3-1/4" W
8 lbs.



ITEM#

CI657M

CAST IRON

1/2"

1" W
2" H
Fits 1/2" Sq

ITEM#

CI7070

3/4"

1-1/4" W
2-1/4" H
Fits over
3/4" Sq.

ITEM#

CI834

1"

1-1/4" W
2-1/2" H
Fits 1" Sq

ITEM#

CI8030

Brass Finial

The thread on the bottom allows for easy installation.

Ø 3-1/8" x 5-1/8"
Ø Base 1-9/16" dia.
threaded hole 1/2"
Wt. 1.5 lbs.



ITEM#

SF16043



Forged Steel Finial

FORGED STEEL

2-3/4" dia.
Wt. 4.9 lbs

ITEM#

SF11310



Brass Finial

Ø 2-1/8" x 3-1/16"
Ø Base 1-9/16"
threaded hole 1/2"
Wt. .7 lb.



ITEM#

SF16046

Actual dimensions may vary slightly due to variations in manufacturer's production.



CAST IRON



1/2"

Fits over
1/2" square
1-1/4" W
1-1/2" H

ITEM#
CI68312

100 pcs per box

1/2"

Fits over
1/2" square
1-1/2" W
1-3/4" H

ITEM#
CI68312BGR

5/8"

Fits over
5/8" square
2" W x 2" H

ITEM#
CI68358

3/4"

Fits over
3/4" square
2" W x 2" H

ITEM#
CI68334

45 pcs per box

1"

Fits over
1" square
2" W x 2" H

ITEM#
CI68310

1 1/2"

Fits over
1-1/2" square
2-3/4" W
2-3/4" H

ITEM #
CI683112XL

CAST IRON



1/2"

Fits over 1/2"
Round
1 5/8" W
1 3/7" H

ITEM#
CI660XS

5/8"

Fits 5/8"
Round
2 1/4" W
2 1/2" H

ITEM#
CI7030

CAST IRON

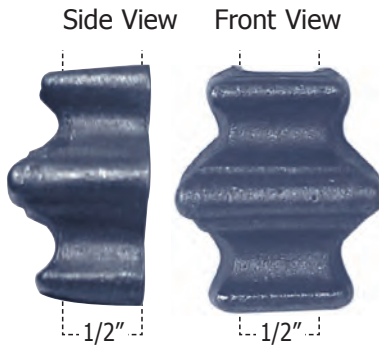

1/2"

1/2"
3/4 collar
1 5/8" W
1 7/8" H

ITEM#
CI685V

- » Grooved for 1/2" square on back side
- » Completely covers three sides of a 1/2" square picket.

CAST IRON



1/2"

Fits over
1/2" Square
2-9/16" H
1-9/16 W

ITEM#
CI212B

CAST IRON

1/2"



Fits 1/2" Square
1 7/8" W 1 3/4" H

ITEM#

CI7035

CAST IRON

1/2"



Baluster collar
Fits 1/2" sq
4" H 2"W

ITEM#

CI7924

CAST IRON

1/2"



Fits 1/2" sq
1 1/8" W
1 7/8" H

ITEM#

CI8527

CAST IRON

1/2"

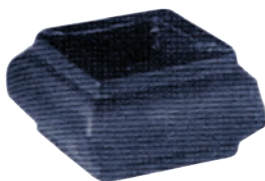

Fits 1/2" sq
1 1/4" W 3/4" H

ITEM#

CI8521

Hollow Steel

1/2"



Mtl 1 3/16"
x 3 11/32" dia.
Hole 1/2" dia.
Wt. .2 lb.

ITEM#

SF1551

Hollow Steel

1/2"



Mtl 1 3/16"
x 2 9/16" dia.
Hole 1/2" dia.
Wt. .2 lb.

ITEM#

SF1552

Steel Tube Bushings

1/2"



Mtl 1 3/16" x
3/4" dia.
Hole 1/2" dia.
Wt. .2 lb.

ITEM#

SF1553

Steel Tube Bushings

1/2"



Mtl 1-3/16"
x 3/4" dia.
Hole 1/2" dia.
Wt. .1 lb.

ITEM#

SF1554

Steel Tube Bushings

1/2"



Mtl 1 3/16" x
2-9/16" dia.
Hole 1/2" dia.
Wt. .2 lb.

ITEM#

SF1556

Steel Bushings

1/2"

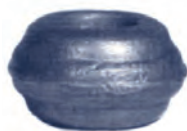

With round
hole 9/16" dia.
Wt. .3 lb.
External dia.
1-9/16"
29/32" H

ITEM#

SF1281

Steel Bushings

1/2"



With square
hole 9/16" sq.
Wt. .3 lb.
External dia.
1-9/16"
7/8" H

ITEM#

SF1282

Steel Tube Bushings

1/2"



Mtl 1 3/16" x
5-7/8" dia.
Hole 1/2" dia.
Wt. .3 lb.

ITEM#

SF1542

Actual dimensions may vary slightly due to variations in manufacturer's production.



1/2"

Fits over 1/2" sq
1-1/4" W 1-1/2" H
.25 lbs

ITEM#

CI8523

3/4"



3/4" sq
Collar 1-7/8" Deep
Base 2" x 2"
.5 lb

ITEM#

CIDD34

1 1/4"

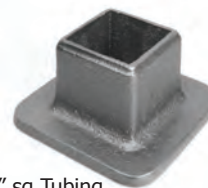

Fits over 1-1/4" sq Tubing
Collar 1-1/2" Deep
Base 3-1/4" x 3-1/4"
1 lb

ITEM#

CI9540

1/2"



Fits 1/2" Round Balusters
Dia 2-7/8" H 1-1/4"
1/2" hole cast in
.5 lb

ITEM#

CI9105

1"



Fits 1" Round Balusters
Dia 4-3/4" H 1-3/4"
1" hole cast in
1 lb

ITEM#

CI9104N

3/4"



Fits 3/4" Round Balusters
Dia 4-3/4" H 1-3/4"
3/4" hole cast
1 lb

ITEM#

CI9106N

2"

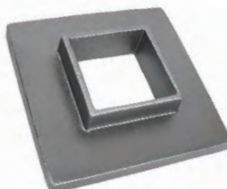

2" sq
Collar 1" Deep
Base 5"x5"
2.5 lbs

ITEM#

CIKK2

Decorative Base



Fits over 3" round
One piece-8 sided
8-1/2" H 6"W 17 lbs

ITEM#

CI8397

Decorative Base



5-1/2" sq base
3-1/2" ID
3-1/2" deep 6 lbs

ITEM#

CI9103

Collar for 4" Standard Pipe

Cast in halves to fit around new or existing pipe

Sold in pairs

Two half sections to weld together

6-3/4" W
8-1/2" H
4-3/4" ID



ITEM#

CI9102

Column Base

Sold in pairs

Two half sections to weld together

Fits 4" sq.
5-3/8" H
6-1/8" sq OD
at bottom
10 lbs



ITEM#

CI8398

Actual dimensions may vary slightly due to variations in manufacturer's production.

Cover Shoe

1/2"



1/2" hole
5/8" tall
1-5/8" Sq. Base

ITEM#
CICC

1/2"



Extra Tall
H 1 1/4"
For 1/2" square.

ITEM#
CISS

For 1" Channel

1 x 1/2"



Height 7/8" width 1 3/8".
Fits 1" x 1/2"

ITEM#
CI653

1"

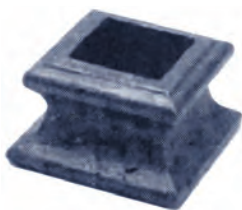

1 3/16" H x 2" W
Fits 1" Square

ITEM#
CI2511

9/16"



1" H x 1 1/2" W
Fits 9/16" Square

ITEM#
CI7055916

1/2"

1" H x 1 1/2" W
Fits 1/2" Square

ITEM#
CI7050

Slip On Shoe

1"

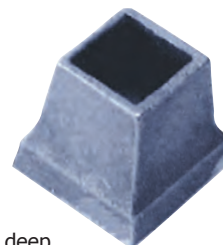

1" x 1 7/8" deep
for 1" sq.

ITEM#
CIDD

For 1" Tubing

1"



Straight I.W. For
1" tubing. One
ear, 1-3/8" deep

ITEM#
CILL

1"



2" H x 3" Square W
Fits 1" Square

ITEM#
CI7040

For 1-1/2" Tubing

1 1/2"



Collar 2" deep
3 3/4" x 3 3/4"

ITEM#
CIHH

Flange Shoe

1 1/4"



Tapered I.W. 1-5/16"
tall 3-3/4" x 2-9/16"
base. For 1-1/4" sq.
tubing.

ITEM#
CIRR

Shoes have 1/2" x 3/16" tapered mounting holes.

1/2"

1/2" flanged,
3/4" deep.

ITEM#
CIEE

5/8"

5/8" sq
Collar 1" Deep
Base 1 3/8"
x 2 9/16"

ITEM#
CIEE58

3/4"

Fits over 3/4" sq
Collar 1" Deep
Base 1 1/2" x 3"

ITEM#
CI9534

1"

Straight inside wall
For 1" sq tubing,
1 1/2" H

ITEM#
CIMM



Actual dimensions may vary slightly due to variations in manufacturer's production.

Simshoe™ Plastic Split Cover Shoe



Simshoe Measures 2" Tall



- » Available in 5 sizes
- » Satin black finish or can be painted
- » Durable ABS plastic
- » No need to add to pickets before set in place; Add knuckles/collars anytime
- » Add small amount of glue & snap sides together for permanent installation

NOTE:

Actual Outside Size of 3" x 3" is 3.5"
Actual Outside Size of 4" x 4" is 4.5"

ITEM#	PICKET	FITS OVER
PS0031	1" sq.	3" x 3"
PS003114	1-1/4" sq.	3" x 3"
PS003112	1-1/2" sq.	3" x 3"
PS004112	1-1/2" sq.	4" x 4"
PS0042	2" sq.	4" x 4"

Simshoe™ Plastic Split Knuckle

Now Available in Two Sizes

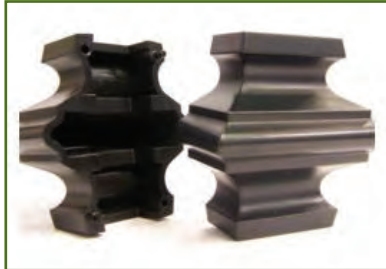

- » For 1/2" pickets or 5/8" pickets
- » Satin black finish or can be painted
- » **No need to add to pickets before set in place; add knuckles/collars anytime**
- » Add small amount of glue & snap sides together for permanent installation

ITEM#	PICKET SIZE	WIDTH	HEIGHT
PS658	5/8"	1-3/4"	1-3/4"
PS612	1/2"	1-3/8"	1-3/8"

Cast Iron Shoe Covers

Fits over baseplates for a finished look

For 1" Square Tubing

- Fits over 3" baseplate

ITEM #	HEIGHT	WIDTH
CI2341	1-7/8"	3-3/8" sq.

For 1-1/2" Square Tubing

- Fits over 3" baseplate

ITEM #	HEIGHT	WIDTH
CI234112	2"	3-5/8" sq.

Round Simshoe® Plastic Halves



- » 1-1/2" H
- » Cover a 3" round base plate
- » Tight fit (small amount of ABS glue is recommended for permanent installation)
- » Durable black ABS plastic with satin black finish or can be painted

ITEM#	ROUND HOLE SIZE	FITS OVER
PS00166	1-5/8" O.D. Pipe	3" OD Round
PS00190	1-7/8" O.D. Pipe	3" OD Round
PS00112	1-1/2" O.D. Tube	3" OD Round

Steel Cover Shoe



For round posts and pickets

ITEM#	HOLE SIZE	OA DIA
CI114RS	1-1/4"⌀	2-3/8"⌀

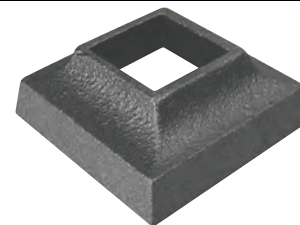

For 2" Square Tubing

- Fits over 4" baseplate

ITEM #	HEIGHT	WIDTH
CI2342	2"	4-5/8" sq.

Decorative Chain

- Chain length: 33 ft.
- Chain weight: 9.4 lbs.

Approximate Link Dimensions:

STEEL

- Material: 3/16" twisted square bar
- Overall length: 2-1/2"
- Overall height: 1"
- Inside length: 2-5/32"
- Inside height: 5/8"

Note: This is a decorative, non-load bearing chain. **Links are not welded.**



ITEM #
SF156A10

Decorative Baluster with Star

- With five-point forged star

Dimensions:

STEEL

- Material: 1/2" square bar
- Height: 39-1/2"
- Width: 3-15/16"
- Weight: 2.7 lbs.



ITEM #
SF13255

Solid Steel Ring with Hammered Edges



ITEM #	MATERIAL	DIAMETER
SF4919	1/2" x 1/2"	4" OD

Solid Steel Twisted Ring



ITEM #	MATERIAL	DIAMETER
SF156A6	1/4" x 1/4"	3" OD

Single faced



CAST IRON

ITEM #	SIZE
CI73	5-1/2"

Single faced

7/16" center hole



CAST IRON

ITEM #	SIZE
CI78	6-1/4"

Steel Curtain Hanger Rings



STEEL

1-7/8" O.D.

ITEM #
CICD880112

2-3/8" O.D.

ITEM #
CICD8802

Single faced



CAST IRON

ITEM #	SIZE
CI76	2-3/4"
CI82	3-1/2"
CI83	4-3/8"

Single faced



CAST IRON

ITEM #	SIZE
CI81	3-3/8"
CI79	4-3/8"

Steel Star

STEEL

Mtl 1/4" x 1/2"
4" dia.
Wt. .4lbs



ITEM #
SF132310

Actual dimensions may vary slightly due to variations in manufacturer's production.

Solid Steel Oval Ring



ITEM #	MATERIAL	SIZE
SF15716	1/2" x 1/4"	4-1/2" x 6-5/16"

Solid Steel Hammered Rings



ITEM #	MATERIAL	DIAMETER
SF156A1	1/4" x 1/4"	1-1/2" OD
SF156A3	1/4" x 1/4"	2" OD
SF156A4	1/4" x 1/4"	2-1/2" OD
SF156A5	1/4" x 1/4"	3" OD

Aluminum Rings

With Steel Weld Tabs



ITEM #	MATERIAL	O.D. SIZE
ACRI312	1/2" x 1/2"	3-1/2"
ACRI4	1/2" x 1/2"	4"
ACRI514	1/2" x 1/2"	5-1/4"

Steel Tube Rings



9 Sizes
Up to 10 Inches OD

ITEM #	MATERIAL	O.D. SIZE
SR312	1/2" x 1/2"	3-1/2"
SR4	1/2" x 1/2"	4"
SR412	1/2" x 1/2"	4-1/2"
SR5	1/2" x 1/2"	5"
SR514	1/2" x 1/2"	5-1/4"
SR512	1/2" x 1/2"	5-1/2"
SR6	1/2" x 1/2"	6"
SR8	1/2" x 1/2"	8"
SR10	1/2" x 1/2"	10"

Made from
Square
Tubing

Solid Steel Rings



6 Sizes
Up to 5.5 Inches OD

Made from solid
square bar
Exposed seam
Non-welded

ITEM #	MATERIAL	O.D. SIZE
SRST312	1/2" x 1/2"	3-1/2"
SRST4	1/2" x 1/2"	4"
SRST412	1/2" x 1/2"	4-1/2"
SRST5	1/2" x 1/2"	5"
SRST514	1/2" x 1/2"	5-1/4"
SRST512	1/2" x 1/2"	5-1/2"

FORGED STEEL SPHERES & BASKETS

Actual dimensions may vary slightly due to variations in manufacturer's production.

Forged Steel Baskets

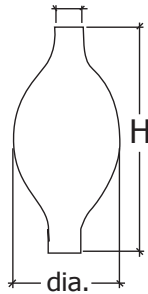

Four Filaments Square Bar

ITEM#	FITS	DIA	HT.	WT.
SF1591	3/8"Sq	1-3/8"	3-9/16"	0.1 lbs.
SF1593	1/2"Sq	2-3/8"	5-1/8"	0.5 lbs.
SF1594	9/16"Sq	2-3/8"	5-1/8"	0.7 lbs.
SF1595	5/8"Sq	2-9/16"	5-3/4"	0.9 lbs.
SF1596	3/4"Sq	3-1/8"	6-1/2"	1.5 lbs.
SF1597	1" Sq	3-3/4"	7-1/16"	2.7 lbs.



Nine Filaments Square Bar

ITEM#	FITS	DIA	HT.	WT.
SF158B1	1/2"Sq	2-1/8"	5-1/8"	0.4lbs



Narrow Basket Four Filaments Square Bar

ITEM#	FITS	DIA	HT.	WT.
SF158B8	1/2"Sq	9/16"	4-15/16"	0.5lbs

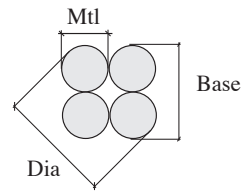

Four Filaments Round Bar

ITEM#	MTL	DIA	BASE	HT.
SF11633	1/4"Dia	9/16"	1/2"	4-15/16"



Solid Brass Four Filaments Square Bar

ITEM#	FITS	DIA	HT.	WT.
SF160L1	1/2"Sq	2-3/4"	5-7/8"	0.5lbs

Forged Sphere Baskets

Six Straight Filaments

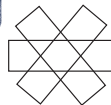
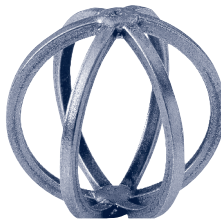

ITEM#	FITS	DIA	WT.
SF116312	1/4"Sq	3-9/16"	0.4lbs

Six Swirled Filaments



ITEM#	FITS	DIA	WT.
SF158B7	1/4"Sq	2-3/4"	0.5lbs

Four Swirled Filaments

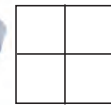

ITEM#	FITS	DIA	WT.
SF158B6	1/4"Sq	2-3/4"	0.5lbs

Steel Spheres



Hollow Steel Smooth, Weldable Finish

ITEM #	DIA	WT.
SFB4	4"	0.5 lbs.
SFB6	6"	3.0 lbs.



Hot Stamped Solid Steel Smooth, Round Finish

ITEM #	DIA	WT.	ITEM #	DIA	WT.
SF116F1	3/4"	0.1 lbs.	SF116F5	2"	1.3 lbs.
SF116F2	1"	0.1 lbs.	SF116F6	2-3/8"	1.9 lbs.
SF116F3	1-3/16"	0.3 lbs.	SF116F8	3-1/8"	3.3 lbs.
SF116F4	1-9/16"	0.6 lbs.	SF116F10	3-15/16"	8.8 lbs.



Forged Solid Steel Faceted Finish

ITEM #	DIA	WT.
SF1172	3/4"	0.1 lbs.
SF1174	1-3/16"	0.3 lbs.
SF1176	1-9/16"	0.5 lbs.
SF1177	2"	1.1 lbs.
SF1178	2-3/8"	2.0 lbs.
SF1179	2-3/4"	3.1 lbs.

Forged Heavy Gauge



1/8" Mtl
3 1/2" x 4 1/2"

ITEM#
SF67512



1/8" Mtl
3 1/2" x 4 1/2"

ITEM#
SF67513

Forged Heavy Gauge



1/8" Mtl
2 1/2" x 3 1/2"

ITEM#
SF6758



1/8" Mtl
2 1/2" x 3 1/2"

ITEM#
SF6759

Forged Elements



4 1/8" dia.
5/32" Mtl

ITEM#
SF94B5



4 15/16" dia.
5/32" Mtl

ITEM#
SF94B6

Forged Elements



3 1/8" H x 3 1/8"
W 5/32" Mtl

ITEM#
SF6951



3 11/32" H x 3 11/32"
W 5/32" Mtl

ITEM#
SF6952

Forged Element

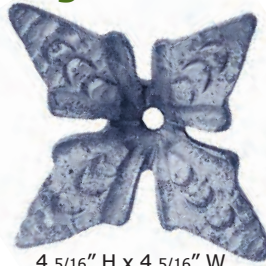

4 5/16" H x 4 5/16" W
5/32" Mtl

ITEM#
SF6953

Forged Element



2 3/8" H x 2 3/8" W
5/32" Mtl

ITEM#
SF6954

Forged Elements



2 3/8" H x 2 3/8" W
5/32" Mtl

ITEM#
SF6955

Heavy Gauge



2 9/16" dia.
Mtl 5/16" hole 19/32" dia.

ITEM#
SF11635

Heavy Gauge



3 3/4" dia.
Mtl 1/8"

ITEM#
SF116A3

Heavy Gauge



2 11/16" dia.
Mtl 1/8"

ITEM#
SF116A4

Heavy Gauge



3 3/4" dia.
Mtl 1/8"

ITEM#
SF116A5

Heavy Gauge

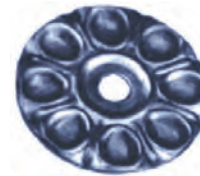

2 3/8" dia.
Mtl 5/64"

ITEM#
SF1382

Heavy Gauge



2 3/8" dia.
Mtl 5/64"

ITEM#

SF13815

Heavy Gauge



3 1/8" dia.
Thick 5/32"

ITEM#

SF1263

Heavy Gauge



3 3/4" dia.
Mtl 1/8"

2 9/16" dia.
Mtl 1/8"

ITEM#

SF6973

ITEM#

SF6974

Heavy Gauge Stamped Steel



Mtl 1/8"
1 9/16" W
4 5/16" H
right hand

ITEM#

SF1361

Mtl 1/8"
1 9/16" W
4 5/16" H
left hand

ITEM#

SF1362

Heavy Gauge Stamped Steel



Mtl 1/8"
2 3/4" W x
6 5/16" H
right hand

ITEM#

SF13610

Mtl 1/8"
2 3/4" W
x 6 5/16" H
left hand

ITEM#

SF13611

Heavy Gauge Stamped Steel



Mtl 1/8"
2 3/4" W x 2 3/8" H
left hand

ITEM#

SF1364

Mtl 1/8"
2 3/4" W x 2 3/8" H
right hand

ITEM#

SF1363

Hand Forged Grape Clusters



Large Grape Bunch

5 1/8" x 10 5/8"

ITEM#

SF140H1



Extra Heavy Leaf

Mtl 3/16"
3 9/16" x 4 15/16"

ITEM#

SF140H3



Tendril

Mtl 1/4" dia.
H 5 7/8"

ITEM#

SF6733



Small Grape Bunch

3 9/16" x 6 5/8"

ITEM#

SF140H2

Light Gauge Stamped Steel



Mtl 5/64"
3 15/32" dia.
H 3 1/8"

ITEM#
SF1383

Mtl 5/64"
3 9/16" dia.
H 3 1/2" Wt.

ITEM#
SF1384

Light Gauge Stamped Steel



Mtl 0.0197"
1 3/4"Wx3 11/32"H

ITEM#
SF13810

Mtl 0.0197"
2 15/16" Wx2 3/4" H

ITEM#
SF13811

Light Gauge Stamped Steel



Mtl 0.0197"
3 3/4"Wx4 1/8"H

ITEM#
SF13812

Light Gauge Stamped Steel



Mtl 0.0197"
2 1/16"Wx2 9/16"H

ITEM#
SF7022

Light Gauge Stamped Steel



Thickness 5/64"
1 1/4"Wx1 3/4"H

ITEM#
SF60411

Stem 1/8"
1 1/4" W
3 1/8"H

ITEM#
SF60412

Light Gauge Stamped Steel



Mtl 0.0197"
7 1/2"W x 7 5/8"H

ITEM#
SF13813

Light Gauge Stamped Steel



Mtl 0.0118"
15/16"dia.x1/2"H

ITEM#
SF1407

Light Gauge Stamped Steel



Mtl 0.0197"
1 5/32"Wx2 9/16"H

ITEM#
SF1391

Light Gauge Stamped Steel



7-7/8"
HEIGHT

Mtl 0.0197"
3 1/8" W x 7 7/8" H

ITEM#
SF7023

Light Gauge Stamped Steel



Mtl 0.0118"
13/16"Wx311/32"H

ITEM#
SF13816

Mtl 0.0118"
1 3/16"Wx311/32"H

ITEM#
SF1387

Light Gauge Stamped Steel



Mtl 0.0197"
1 39/64"Wx3 9/16"H

ITEM#
SF1392

Light Gauge Stamped Steel



Mtl 0.0197"
1 1/2" dia.x 1 9/16"H

ITEM#
SF1367



*Combine These
Three Pieces to
Form a Decorative Flower*

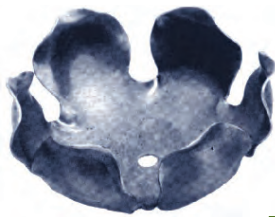

Mtl 0.0197"
2 9/16" dia.x 1 3/16" H

ITEM#
SF1365

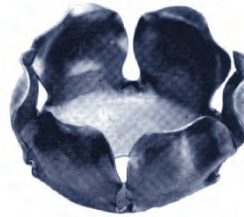

Mtl 0.0197"
2 1/8" dia.x 1 19/64" H

ITEM#
SF1366

Light Gauge Stamped Steel



Single Faced

Mtl 0.0197"
2" W x 3 9/16" H

ITEM#
SF1378

Light Gauge Stamped Steel

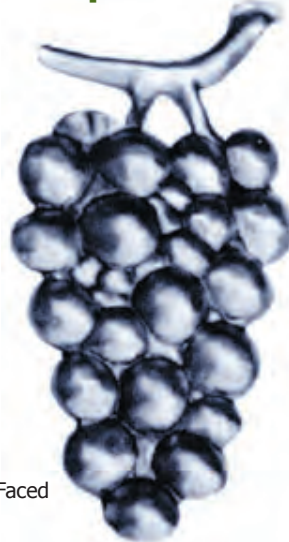

Single Faced

Mtl 0.0197"
2 3/8" W x 5 1/8" H

ITEM#
SF1377

Large Stamped Steel Rose



1-9/16" Width
5-1/2" Diameter

ITEM # DESCRIPTION
SF14063



6" Width

Mtl 0.0197"
6 7/8" W x 4 15/16" H

ITEM#
SF13710



4" Width
Single Faced
Mtl 0.0197"
4 5/16" W x 2 9/16" H

ITEM#
SF1379

Forged Steel Flowers



19-11/16"
HEIGHT

- On stem

Material: 5/16" Dia.
Width: 5-1/8"
Height: 19-11/16"

ITEM #

SF13296



17-3/4"
HEIGHT

- On stem

Material: 5/16" Dia.
Width: 5-1/2"
Height: 17-3/4"

ITEM #

SF13291

Weldable Cast Steel Leaf



6-1/8"
HEIGHT

Mtl 5/16" dia.
4 5/16" W
6 1/8" H

ITEM#

SF6613



4-15/16"
HEIGHT

Mtl 5/16" dia.
3" W
4-15/16" H

ITEM#

SF6614

**Find Accent Paints
on Pages 238-239**



5-1/2" HEIGHT

Mtl 5/8" x 1/4"

ITEM#

SF6631

4 5/16" W

5 1/2" H

ITEM#

SF6632



Weldable Cast Steel Benefits: Fully Weldable | Economical | Fully Detailed

Weldable Cast Steel



13"
HEIGHT
4 5/16" W
13" H
5/32" Mtl
Wt. 2.1 lbs.
ITEM#
SF6928



7-1/16"
HEIGHT
2" W
7 1/16"
H x 5/32" Mtl
Wt. .6 lb.
ITEM#
SF6929

Weldable Cast Steel



Mtl 1/2" dia.
2 9/16" W x 5 1/8" H
ITEM#
SF6623



5-1/8" HEIGHT
Mtl 1/2" dia.
2 9/16" W x 5 1/8" H
ITEM#
SF6624

Weldable Cast Steel



Mtl 1/2" dia.
2 3/4" W x 3 9/16" H
Wt. .3 lb.
LIMITED QUANTITY AVAILABLE
ITEM#
SF6633



3-9/16" HEIGHT
Mtl 1/2" dia.
2 3/4" W x 3 9/16" H
Wt. .3 lb.
LIMITED QUANTITY AVAILABLE
ITEM#
SF6634



ITEM#
SF6897

6-5/16"
WIDE
1/2" dia.
6 5/16" W
3 15/16" H
3/16" Mtl
Wt. .7 lb.



ITEM#
SF6898



ITEM#
SF6913

4-3/4" HEIGHT
1/2" dia.
2-3/4" W
4-3/4" H
3/16" Mtl
Wt. .2 lb.



ITEM#
SF6914



ITEM#
SF94B9

4-3/4" HEIGHT
4-3/4" H
3-11/32" W
5/32" Mtl
Wt. .3 lb.



ITEM#
SF94B10

Forged Steel Horseshoe



4-5/8" W
5" H

ITEM#
SC101H

Weldable Cast Steel Benefits: Fully Weldable | Economical | Fully Detailed

Weldable Cast Steel

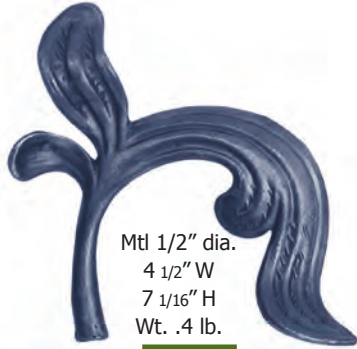

Mtl 1/2" dia.
4 1/2" W
7 1/16" H
Wt. .4 lb.

ITEM#
SF6635

7-1/16"
HEIGHT



Mtl 1/2" dia.
4 1/2" W
7 1/16" H
Wt. .4 lb.

ITEM#
SF6636

Weldable Cast Steel



Mtl 5/8"-5/16"
5 1/2" W
6 1/8" H

ITEM#
SF6611

6-1/8"
HEIGHT



Mtl 5/8"-5/16"
5 1/2" W
6 1/8" H

ITEM#
SF6612

Weldable Cast Steel



7 1/16" H x
5 1/8" W x 5/32" Mtl
Wt. .7 lb.

ITEM#
SF94B11

7-1/16"
HEIGHT



7 1/16" H x
5 1/8" W x 5/32" Mtl
Wt. .7 lb.

ITEM#
SF94B12



Mtl 1/2" dia.
6 5/16" W
7 1/2" H
Wt. .9 lb.

ITEM#
SF6637

7-1/2" HEIGHT



Mtl 1/2" dia.
6 5/16" W x 7 1/2" H

ITEM#
SF6638

Wt. .9 lb.



7-1/2" WIDE

1/2" dia.
7 7/8" W
5 7/8" H
3/16" Mtl
Wt. 1 lb.

ITEM#
SF6899



ITEM#
SF68910

6-5/16"

WIDE
1/2" dia.
6 5/16" W
3 15/16" H
3/16" Mtl
Wt. .5 lb.

ITEM#
SF6912



ITEM#
SF6911

Classic Italian Craftsmanship

These Tubular Scrolls Give the Look & Feel of Solid Wrought Iron. They are Designed Using a High-Quality, Light-Weight Tube, Allowing for an Easier Installation and Weight Reduction.

EASIER
Install

Each Scroll is a Hollow Steel Tube Formed into a Classic "C" or "S" Scroll

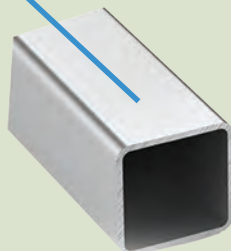

Hot Forged Steel
Fishtail Ends

1/2"

5-1/8" x 15"

ITEM#
SF6514

1/2"

5-5/16" x 14-1/8"

ITEM#
SF6513

Forged Steel Tubular S-Scrolls

5/8"

10" x 20-3/8"

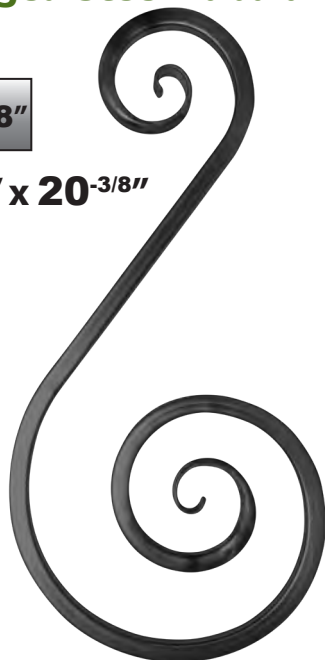

ITEM#	SIZE
SFF080	5/8"

3/4" or 1"

9-3/4" x 19-5/8"

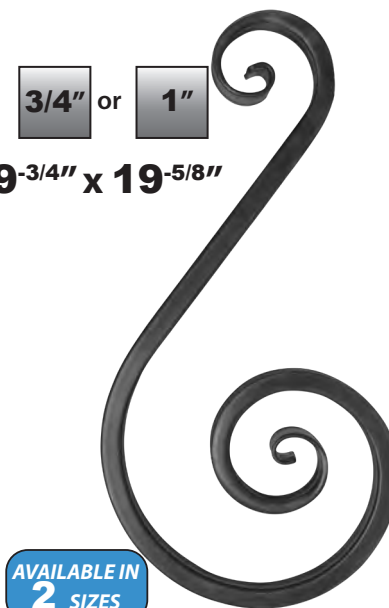

AVAILABLE IN
2 SIZES

ITEM#	SIZE
SFF060	3/4"
SFF058	1"

5/8"

4-3/4" x 10"
6-1/4" x 13-1/2"



AVAILABLE IN
2 SIZES

ITEM#	SIZE
SFF082	4-3/4" X 10"
SFF081	6-1/4" X 13-1/2"

Forged Steel Tubular C-Scrolls

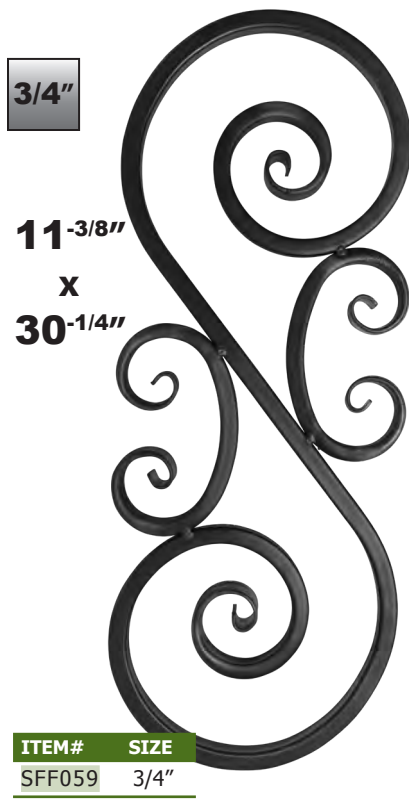
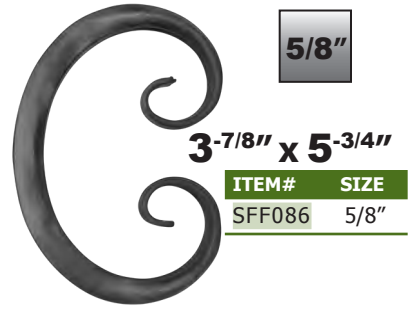
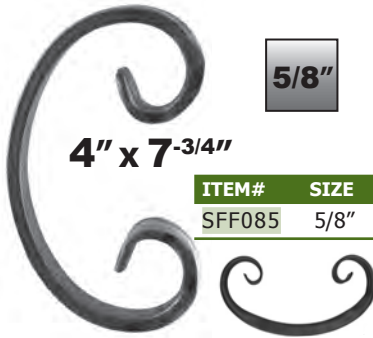
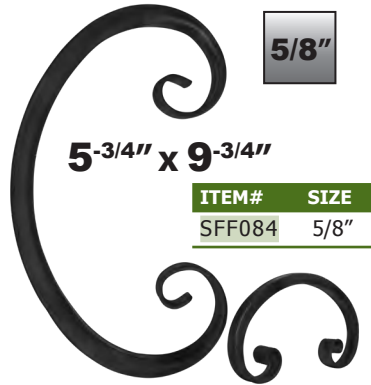

Forged Steel Tubular S-Scrolls

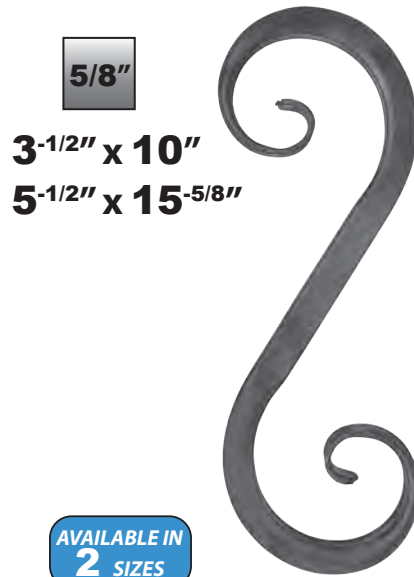
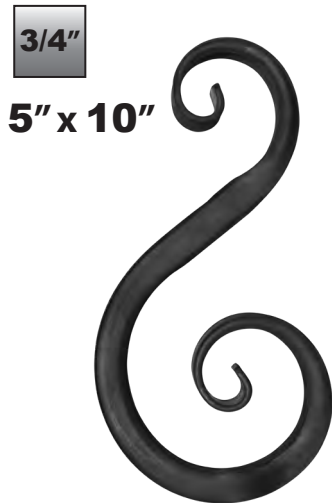

AVAILABLE IN
2 SIZES

ITEM#	SIZE
SFF079	3/4"

ITEM#	SIZE
SFF077	3-1/2" X 10"
SFF078	5-1/2" X 15-5/8"

ITEM#	SIZE
SFF083	5/8"

Round Bar Scrolls

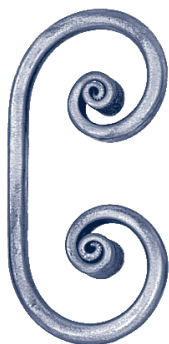

Mtl 1/2" dia. Rd.
3 9/16" W
7 1/16" H

ITEM#
SF12956



Mtl 1/2" dia. Rd.
2 3/8" W x 4 1/2" H

ITEM#
SF12957



Hammered
Mtl 1/2" dia. Rd.
2 3/4" W x 4 5/16" H

ITEM#
SF129613



Hammered
Mtl 1/2" dia. Rd.
3 9/16" W x 5 5/16" H

ITEM#
SF129612

Square Grooved Material



Mtl 1/2" x 1/2"
4 15/16" W

ITEM#
SF6351

17-3/4" HEIGHT



Mtl 1/2" x 1/2"
4 5/16" W

ITEM#
SF6353

14-1/2" HEIGHT



Mtl 1/2" x 1"
6 1/8" W

ITEM#
SF6352

15" HEIGHT



Mtl 1/2" x 1/2"
3 3/4" W

ITEM#
SF6354

11-7/16" HEIGHT



Shown SF129612



Solid Round Bar Scrolls

8-5/8" HEIGHT



Mtl 1/2" dia. Rd.
4 3/4" W

ITEM#
SF12954



Mtl 1/2" dia. Rd.
4 1/2" W

10-1/2" HEIGHT



ITEM#
SF12955

Mtl 1/2" dia. Rd.
4 3/4" W

14-3/16" HEIGHT



ITEM#
SF12951

Mtl 1/2" dia. Rd.
4 3/4" W

14-3/16" HEIGHT



ITEM#
SF12952

Heavy 1/2" Thick Scrolls

Mtl 1/2" sq.
4 1/8" W x 8 5/8" H

ITEM#
SF94P1



Mtl 1/2" sq.
4 1/3" W x 6 1/3" H

ITEM#
SF10466



Mtl 1/2" sq.
4 1/8" W x 8 5/8" H

ITEM#
SF94Q1



Mtl 1/2" sq.
3 3/4" W x 6" H

ITEM#
SF94Q5



Solid Steel Scrolls

Mtl. 1/2" sq
6 11/16" W x 28 11/32"

ITEM#
SF721



Solid Steel Scrolls

Mtl 5/16" x 5/16"
4 5/16" W x 9 1/16" H

ITEM#
SF732



Solid Steel Scrolls

Mtl 5/16" x 5/16"
3 9/16" W x 7 1/16" H

ITEM#
SF733



Solid Steel Scrolls

Mtl 5/16" x 5/16"
4 3/4" W x 13 3/4" H

ITEM#
SF7533



Solid Steel Scrolls

Mtl 5/16" x 5/16"
4 5/16" W x 11 13/16" H

ITEM#
SF731



Hand Forged Scrolls



Mtl 1/2" dia. Rd.
4 5/16" W x 17 3/4" H

ITEM#
SF13091



Mtl 1/2" dia. Rd.
4 5/16" W x 17 3/4" H

ITEM#
SF13092



Mtl 1/2" sq.
4 5/16" W x 17 3/4" H

ITEM#
SF13093



Mtl 1/2" sq.
4 5/16" W x 17 3/4" H

ITEM#
SF13094



4 5/16" x 17 3/4" H

ITEM#
SF13095

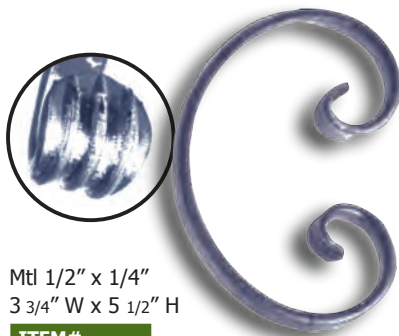

Mtl 1/2" x 1/4"
3 3/4" W x 5 1/2" H

ITEM#
SF80A10

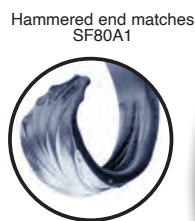

Mtl 1/2" x 1/4"
ITEM#
SF80A3

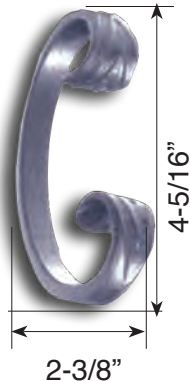

Mtl 1/2" x 1/4"
2-3/4" W x 4-1/8" H
ITEM#
SF80A9



Mtl 3/4" x 1/4"
5 7/8" x 8 7/8"

ITEM#
SF847



Mtl 9/16" dia. round
6 5/16" W x 8 7/8" H

ITEM#
SF6348

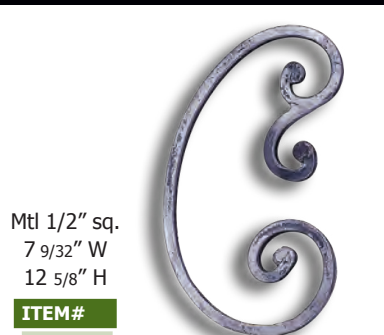

Mtl 1/2" sq.
7 9/32" W
12 5/8" H

ITEM#
SF10464

FORGED STEEL SCROLLS



Mtl 1/2" sq.
7 1/16" W x 17 1/2" H

ITEM#
SF10465



Mtl 5/16" x 5/16"
4 1/2" W x 4 15/16" H

ITEM#
SF892



Mtl 1/2" x 1/4"
ITEM#
SF80A1

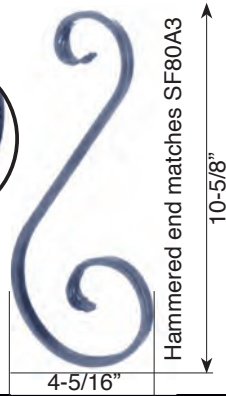

Hammered end matches SF80A3
10-5/8"

4-5/16"

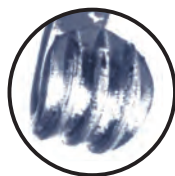

Mtl 1/2" x 1/4"
2 9/16" W x 5 7/8" H

ITEM#
SF80A11

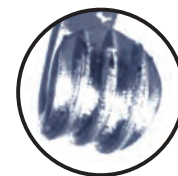

Mtl 1/2" x 1/4"
2 3/4" W x 7 1/2" H

ITEM#
SF80A12



Mtl 1/2" sq.
9 7/16" W
17 1/8" H

ITEM#
SF10463



Mtl. 1" x 1/2"
10 1/4" W x 25 3/16" H

ITEM#
SF13151

Hammered

Good match for SF4752 and SF4792



Mtl. 1/2" x 1/4"
4 3/4" W
14 11/64" H

ITEM#
SF742

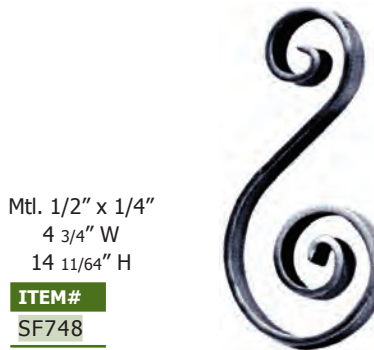

Mtl. 1/2" x 1/4"
4 3/4" W
14 11/64" H

ITEM#
SF748

Mtl 1/2" sq.
4 5/16" W
35 7/16" H

ITEM#
SF4791



Scrolls with Leaves

Mtl 1/2" x 1/4"
7 7/8" W
17 3/4" H
ITEM#
SF933



Mtl 1/2" x 1/4"
12 5/8" W
17 3/4" H
ITEM#
SF931



Mtl 1/2" x 1/4"
9 1/6" W x 13 3/4" H
ITEM#
SF934



6 5/8" H x 4 5/16" W
3/8" dia.
ITEM#
SF94C3



6 5/8" H x 4 5/16" W
3/8" dia.
ITEM#
SF94C4



10 5/8" H x 7 1/2" W
3/8" dia.
ITEM#
SF94C5



10 5/8" H x 7 1/2" W
3/8" dia.
ITEM#
SF94C6



Mtl 1/2" x 1/4"
5 7/8" W x 7 7/8" H
ITEM#
SF943



Mtl 1/2" x 1/4"
6 5/16" W x 9 7/8" H
ITEM#
SF92B4

Flared Scrolls



Mtl 1/2" x 1/4"
4 3/4" W
11 13/16" H
ITEM#
SF52H3



Hammered

Mtl 1/2" x 1/4"
4 1/8" W
5 7/8" H
ITEM#
SF64G3



Mtl 1/2" x 1/4"
3 1/8" W
13 3/4" H
ITEM#
SF92B3



Mtl 1/2" x 1/4"
2" W
9 1/16" H
ITEM#
SF64G6



Mtl 1/2" x 1/4"
2 3/8" W
4 1/8" H
ITEM#
SF64G5



Mtl 1/2" x 1/4"
2 3/8" W
4 1/8" H
ITEM#
SF64G4



FORGED STEEL SCROLLS



ECONOMICAL!

**These scrolls
can form all
these designs
and more!**

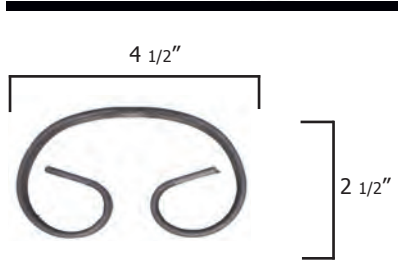

1/8" x 1/2" Weldable Steel Strip

ITEM#

SFC4

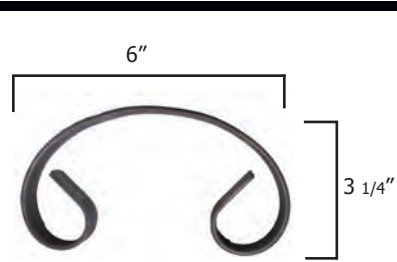

1/8" x 1/2" Weldable Steel Strip

ITEM#

SFC6

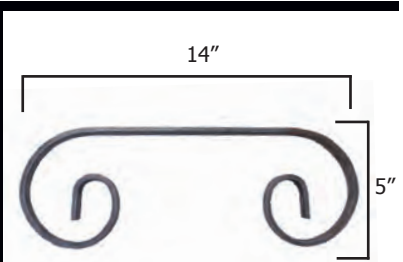

1/8" x 1/2" Weldable Steel Strip

ITEM#

SFC14



12" Height x 4-3/4" Wide
1/8" x 1/2" Weldable Steel Strip

ITEM#

SFS12

**Customize Your
Scrolls by
Adding Optional
Fishtails
to the Ends**

*Fishtail Ends are Custom.
Please Inquire With Sales
for Details.*



14" Height x 4-3/4" Wide
1/8" x 1/2" Weldable Steel Strip

ITEM#

SFS14

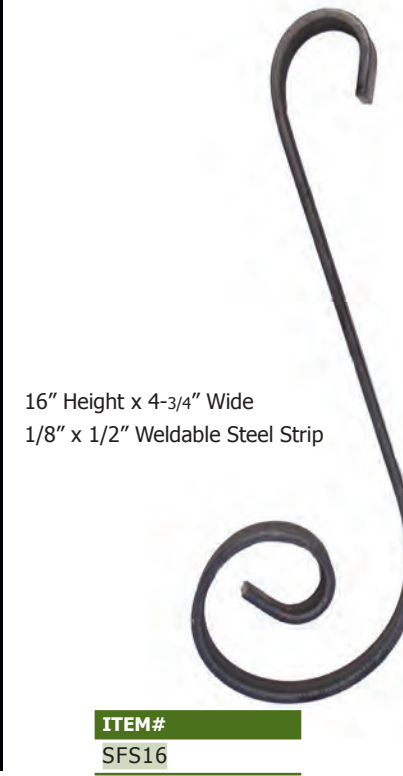

16" Height x 4-3/4" Wide
1/8" x 1/2" Weldable Steel Strip

ITEM#

SFS16

These Large Scrolls Are Great As Gate-Tops!

Lightly Grooved Edge



ITEM# Mtl 5/8" x 5/16"
SF12811 51 3/16" W x 17 1/2" H

Lightly Grooved Edge



ITEM# Mtl 5/8" x 5/16"
SF12812 48 1/4" W x 17 1/2" H

Lightly Grooved Edge

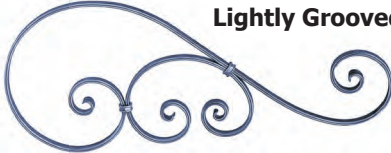

ITEM# Mtl 5/8" x 5/16"
SF12813 32 5/8" W x 13 3/8" H

Lightly Grooved Edge



ITEM# Mtl 5/8" x 5/16"
SF12814 30" W x 10 1/4" H

Plain Edge

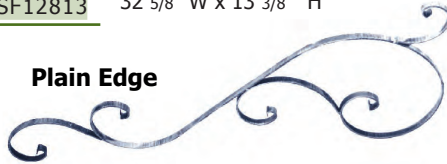

ITEM# Mtl 3/4" x 1/4"
SF116D1 50 3/8" W x 17 5/8" H



ITEM# Mtl 1/2" x 1/4"
SF116E2 40 9/16" W x 9 7/16" H



ITEM# Mtl 1/2" x 1/4"
SF116E4 27 9/16" W x 8 11/16" H



ITEM# Mtl 5/8" x 1/4"
SFGD2711 30 5/16" W x 7 7/8" H

HIGH-QUALITY FORGED STEEL PANELS



Mtl 1/2" sq.
19 9/32" W
40 35/64" H

ITEM#
SF10432



Mtl 5/16" sq.
10 5/8" W
31 1/2" H

ITEM#
SF581



Mtl 1/2" sq.
14" W
35" H

ITEM#
SF5411



Mtl 1/2" sq.
9" W
32 3/4" H

ITEM#
SF116D3



Mtl 1/2" sq.
9 27/32" W
35 7/16" H

ITEM#
SF10461



Mtl 1/2" sq.
7 7/8" W
35 7/16" H

ITEM#
SF10462



Mtl 1/4" x 3/4"
8" W
18" H

ITEM#
SF12793



Mtl 1/2" sq.
8 1/4" W
40 1/2" H

ITEM#
SF10431

PLEASE NOTE THE SIZES ON THESE PANEL



Mtl 1/2" dia. Rd.
4 3/4" W x 6 5/8" H

ITEM#
SF6873



Mtl 1/2" dia. Rd.
4 3/4" W x 6 5/8" H

ITEM#
SF6876



18 1/8" H x 17 5/16" W
1/2" dia. Rd.

ITEM#
SF94E1



18 1/8" H x 17 5/16" W
1/2" dia. Rd.

ITEM#
SF94E2



14 1/2" H x 13" W
1/2" dia. Rd.

ITEM#
SF94C11



14 1/2" H x 13" W
1/2" dia. Rd.

ITEM#
SF94C12



24 13/32" H x 16 1/8" W
1/2" dia. Rd.

ITEM#
SF94E5



24 13/32" H x 16 1/8" W
1/2" dia. Rd.

ITEM#
SF94E6



21 1/4" H x 12 1/4" W
1/2" dia. Rd.

ITEM#
SF94E3



21 1/4" H x 12 1/4" W
1/2" dia. Rd.

ITEM#
SF94E4



Mtl 5/8" x 5/16"
10 5/8" W x 23 5/8" H

ITEM#
SF6811



Mtl 5/8" x 5/16"
10 5/8" W x 23 5/8" H

ITEM#
SF6812



5 1/8" W x 3 15/16" H
5/32" Mtl

ITEM#
SF94C1



6 5/8" W x 5 1/2" H
5/32" Mtl

ITEM#
SF94C2



Available in Two Lengths 47-3/4" or 45-23/64"

Mtl 5/64"
1 25/32" H
47 3/4"L
Wt. 1.1 lbs

ITEM#

SF8527

Mtl 1/4"
3 5/16" H
45 23/64"L
Wt. 5.5 lbs

ITEM#

SF8526



Mtl 1/2" sq.
3-3/4" W
7-9/32" H
Wt. 1.5 lbs.

ITEM#

SF11442



1/2" Sq. Matl.
7-3/32" W
39-3/8" H
Wt. 8.2 lbs.

ITEM#

SF11421

Steel Pickets for 1/2" Bar or Tube



Fits Over
1/2"

Mtl 1/2" x 1/4"
8 1/6" W x 17 1/2" H
Wt. 2.7 lbs.

ITEM#

SF351



Fits Over
1/2"

Mtl 1/2" x 1/4"
7 7/8" W x 13 9/16" H
Wt. 2.1 lbs.

ITEM#

SF352



Fits Over
1/2"

Mtl 1/2" x 1/4"
3 3/4" W x 3 3/4" H
Wt. 6 lb.

ITEM#

SF373



Fits Over
1/2"

Mtl 1/2" x 1/4"
9 1/16" W
15" H
Wt. 2.8 lbs.

ITEM#

SF362

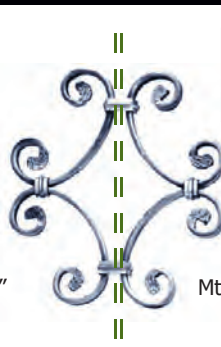

Fits Over
1/2"

Mtl 1/2"x1/4"
8 5/8" W
9 7/8" H
Wt. 1.7 lbs.

ITEM#

SF361

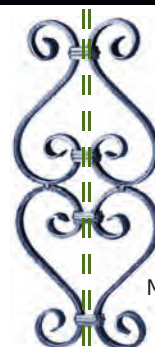

Fits Over
1/2"

Mtl 1/2" x 1/4"
7" W
15" H
Wt. 2.4 lbs

ITEM#

SF13004

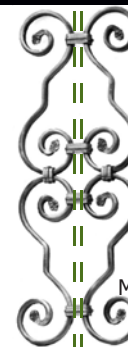

Fits Over
1/2"

Mtl 1/2" x 1/4"
6 5/16" W
17 5/16" H
Wt. 3 lbs

ITEM#

SF371



Mtl 5/16" sq.
5 3/4" W
35 7/16" H
Wt. 3.2 lbs.

ITEM#
SF4691



Mtl 1/2" sq.
10 1/4" W
35 7/16" H
Wt. 5 lbs.

ITEM#
SF64A2



Mtl 1/2" sq.
8 5/8" W
35 7/16" H
Wt. 4 lbs.

ITEM#
SF64A3



Mtl 1/2" sq.
8 5/8" W
35 7/16" H
Wt. 4.4 lbs.

ITEM#
SF64B2



Mtl 1/2" sq.
7 1/4" W
35 7/16" H
Wt. 7.2 lbs.

ITEM#
SF52E2



Mtl 1/2" sq.
10 1/4" W
35 7/16" H
Wt. 6.3 lbs.

ITEM#
SF52F1



Mtl 1/2" sq.
9 1/4" W
35 7/16" H
Wt. 5.5 lbs.

ITEM#
SF522



Mtl 1/2" sq.
6 5/8" W
35 7/16" H
Wt. 3.5 lbs.

ITEM#
SF52A3



Mtl 1/2" sq.
9 1/4" W
35 7/16" H
Wt. 5.1 lbs.

ITEM#
SF531



Mtl 1/2" x 1/4"
13 3/4" W
34 1/4" H
Wt. 5.5 lbs.

ITEM#
SF521



Mtl 1/2" x 1/4"
13 3/4" W
34 1/4" H
Wt. 7.3 lbs.

ITEM#
SF16713

FORGED STEEL ROSETTES



Mtl 3/8" x 3/16"
7 1/16" H x 6 1/8" W Wt. 1 lbs.

ITEM#
SF901



Mtl 1/2" round. 10 5/8" dia.
Wt. 3.31 lbs.

ITEM#
SF10142



Mtl 1/2" sq. 11 5/8" dia.
Wt. 6.6 lbs.

ITEM#
SF10132



Mtl 3/8" round 17 5/16" dia.
Wt. 5.7 lbs.

ITEM#
SF10111

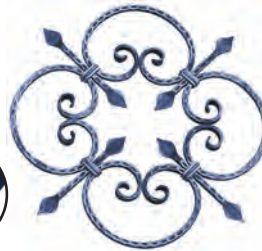
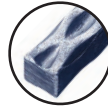

Mtl 1/2" sq. 21 7/8" dia.
Wt. 10.8 lbs.

ITEM#
SF10113



Mtl 1/2" round. 22 1/32" dia.
Wt. 11.4 lbs.

ITEM#
SF10121



Mtl 1/2" round. 10 13/16" dia.
Wt. 2.8 lbs.

ITEM#
SF10174



Mtl 5/16" 9 7/8"H
Wt. 2 lbs.

ITEM#
SF171



Mtl 5/16" 9 7/8"H
Wt. 2 lbs.

ITEM#
SF172



Mtl 3/8" x 3/16" 9 7/8" dia.
Wt. 1.7 lbs.

ITEM#
SF231

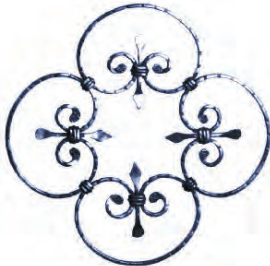

Mtl 3/8" x 3/16" 15" dia.
Wt. 3.3 lbs.

ITEM#
SF242



Mtl 1/2" 23 5/8"H
Wt. 13 lbs.

ITEM#
SF243

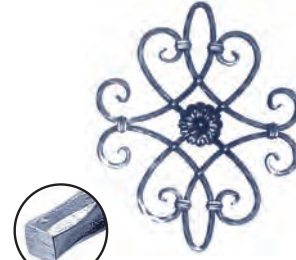

Mtl 1/2" 16-5/8" W
20-5/8" H
Wt. 10 lbs.

ITEM#
SF26C1



Mtl 3/4" x 5/32" 9 7/8" dia.
Wt. 2.3 lbs.

ITEM#
SF232

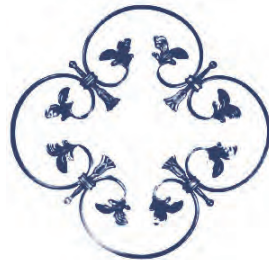

Mtl 1/2" x 1/4" 18 1/8" dia.
Wt. 4.4 lbs.

ITEM#
SF24B1



Mtl 9/16" Round 24 1/2" H.
Wt. 14.1 lbs.

ITEM#
SF4471



Mtl 5/16" 22 5/8" dia.
Wt. 6.4 lbs.

ITEM#
SF4511



Mtl 9/16" Round 22 1/4"H
Wt. 12.5 lbs.

ITEM#
SF4464

Visit Us Online
www.steelmartatlanta.com
or
Call Us
Tucker: (770) 416-6999
Gainesville: (770) 297-6675

FORGED GRILLS & FLORAL ELEMENTS



Mtl 1/2" dia.
16 1/2" W x 16 1/2" H
Wt. 7.6 lbs.

ITEM#
SF6791

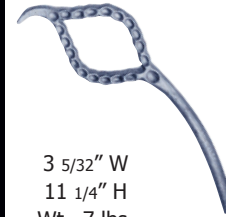

3 5/32" W
11 1/4" H
Wt. .7 lbs.

ITEM#
SF6649



Mtl 1/2" dia.
22 7/8" W x 34 5/8" H
Hammered
Wt. 14.0 lbs.

ITEM#
SF7151



Mtl 1/2" dia.
22 7/8" W x 34 5/8" H
Hammered
Wt. 14.0 lbs.

ITEM#
SF7152

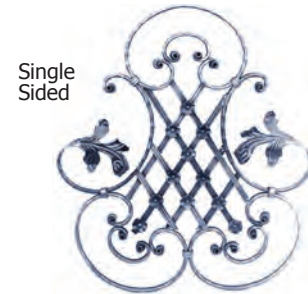

Single
Sided

Mtl 5/8" x 5/16"
25 3/16" W x 27 15/16" H

ITEM#
SF7192



Mtl. 5/32"
15 3/4" W
16 7/8" H
Wt. 5.3 lbs.

ITEM#
SF6963

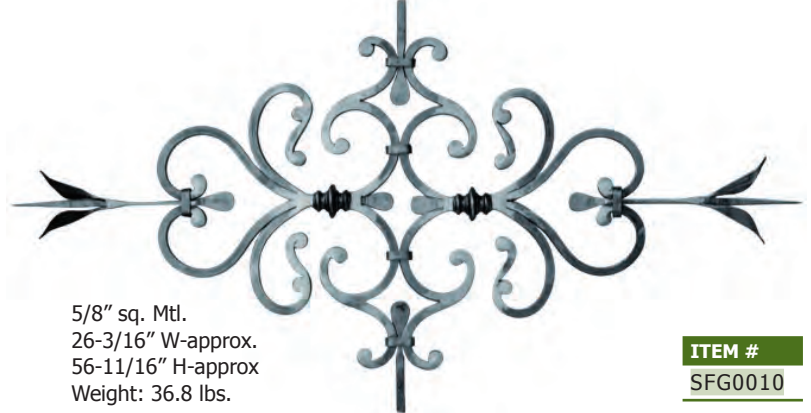

5/8" sq. Mtl.
26-3/16" W-approx.
56-11/16" H-approx.
Weight: 36.8 lbs.

ITEM #
SFG0010



5/8" sq. Mtl.
31-7/8" W - approx.
41-3/8" H - approx.
Weight: 24.7 lbs.

ITEM #
SFG0011



Mtl 5/8" x 5/16"
36 1/4" W x 11 1/32" H
Wt. 8.2 lbs.

ITEM#
SF6961



Mtl 9/16"
20 9/32" W X 26 3/8" H
Wt. 15 lbs.

ITEM#
SF7191



Mtl 1/2" X 1/4"
16 5/16" H
Wt. 5.7 lbs.

ITEM#
SF7202



Mtl 9/16"
20 9/32" W X 26 3/8" H
Wt. 15.4 lbs.

ITEM#
SF7201



Mtl 1/2" X 1/4"
25 1/2" dia.
Wt. 14.3 lbs.

ITEM#
SF16421



Mtl 1/2" X 1/4"
9 7/8" dia.
Wt. 1.6 lbs.

ITEM#
SF91046



ADJUSTABLE TO
24 3/8" x 15"

Mtl 5/8" x 5/16"
22 7/8" x 17 5/8"
Wt. 8.8 lbs.

ITEM#
SF91041



Mtl 5/8" x 5/16" Rect.
16-9/16" W x 39-3/8" H
Weight: 22.9 lbs.

ITEM #
SFGD991



5/8" x 5/16" Mtl.
22-5/8" H x 15-3/4" W
Weight: 8.8 lbs.

ITEM #
SF16574



Mtl 9/16" sq.
20 25/32" W X 22 1/32" H
Plain - Wt. 9.2 lbs.

ITEM#
SF10382



ITEM#
SF10381

Mtl 9/16" sq.
20 25/32" W X 42 1/2" H
Plain - Wt. 18.7 lbs.

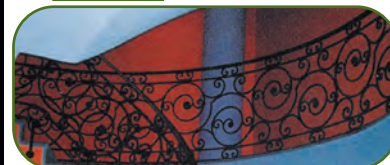

Forged Panel

Material: 9/16" x 5/16" Rect.
30-5/16" W
21-21/32" H
Weight: 17.8 lbs.



ITEM #

SFGD1512

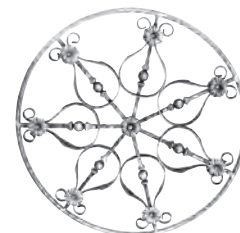

Material: 9/16" Square
Overall Diameter: 28-15/16"
Weight: 28.6 lbs.

ITEM #

SF7181



Double sided with stamped flower embellishments

Material: 9/16" x 5/16" Rect.
Overall Diameter: 27"
Weight: 19.8 lbs.

ITEM #

SF16673

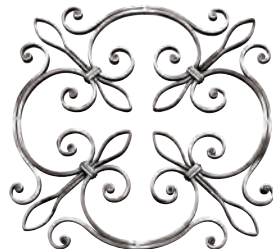

Material: 9/16" x 5/16" Rect.
Overall Diameter: 23-1/4"
Weight: 12.1 lbs.

ITEM #

SF16672



Material: 9/16" x 5/16" Rect.
Overall Diameter: 20-11/16"
Weight: 11.2 lbs.

ITEM #

SF16682



Material: 9/16" Dia. Round
Width: 10"
Height: 34-5/8"
Weight: 10.8 lbs.

ITEM #

DESCRIPTION

SFGD0045

Scroll Panel



Material: 9/16" Dia. Round
Width: 10"
Height: 31-7/8"
Weight: 9.9 lbs.

ITEM #

DESCRIPTION

SFGD0046

Scroll Panel



Material: 5/8" x 5/16" Rect.
Width: 11-13/16"
Height: 41-3/4"
Weight: 10.18 lbs.

ITEM #

DESCRIPTION

SFGD0047

Scroll Panel



Material: 5/8" x 5/16" Rect.
Width: 11-13/16"
Height: 37-13/16"
Weight: 9.41 lbs.

ITEM #

DESCRIPTION

SFGD0043

Scroll Panel



9/16" sq. Mtl.
7-7/8" W
39-3/8" H
Weight: 7.9 lbs.

ITEM #

SFG1761



9/16" sq. Mtl.
7-7/8" W
39-3/8" H
Weight: 9 lbs.

ITEM #

SFG1763



9/16" sq. Mtl.
4-23/32" W
39-3/8" H
Weight: 3.9 lbs.

ITEM #

SFG231



9/16" sq. Mtl.
4-23/32" W
39-3/8" H
Weight: 4.5 lbs.

ITEM #

SFG251



5/16" x 1/2" Mtl.
7-1/2" W
39-1/2" H
Weight: 7.5 lbs

ITEM#

SF16802



1/2" dia. Rd. Mtl.
5-1/8" W
39-3/8" H
Weight: 5.7 lbs.

ITEM #

SFG1923



Mtl: 1/2" sq.
W: 5-1/2"
H: 35-7/16"
Wt: 4 lbs.

ITEM#
SF134G1



Mtl: 1/2" sq.
W: 5-1/2"
H: 35-7/16"
Wt: 3 lbs.

ITEM#
SF134G2



Mtl: 1/2" sq.
H: 35-7/16"
Wt: 2.2 lbs.

ITEM#
SF134G3



Mtl: 1/2" sq.
H: 35-7/16"
Wt: 2.5 lbs.

ITEM#
SF134G4



Mtl: 1/2" sq.
W: 4-29/32"
H: 39-3/8"
Wt: 2.3 lbs.

ITEM#
SF10561



Mtl: 1/2" sq.
W: 6-7/8"
H: 39-3/8"
Wt: 3 lbs.

ITEM#
SF10841



Mtl: 5/16" x 9/16"
W: 4-23/32"
H: 35-1/2"
Wt: 4 lbs.

ITEM#
SF5443



Mtl: 1/2" sq.
Wt: 7-3/32"
H: 35-7/16"
Wt: 2.6 lbs.

ITEM#
SF469

LIMITED QUANTITY AVAILABLE



Mtl 9/16" sq.
39 1/2" H
Wt. 3.4 lbs

ITEM#
SF80272

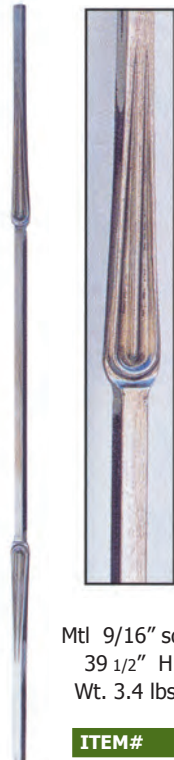

Mtl 9/16" sq.
39 1/2" H
Wt. 3.4 lbs

ITEM#
SF80276



Mtl 9/16" sq.
39 1/2" H
Wt. 3.6 lbs

ITEM#
SF80278



Mtl 1" sq.
47 1/4" H
Wt. 13 lbs

ITEM#
SF802716

Newel Post



Mtl 1" sq.
47 1/4" H
Wt. 13 lbs

ITEM#
SF80279



Mtl 9/16" sq.
39 1/2" H
Wt. 3.4 lbs

ITEM#
SF802711



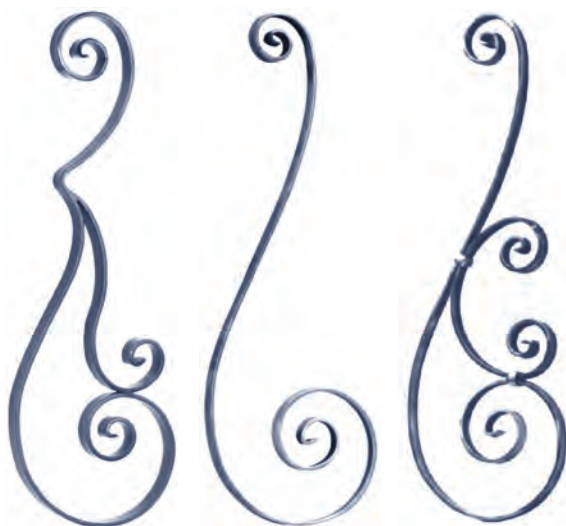

Mtl 1 3/16" x 5/16"
11 1/32" W
31 7/8" H
Wt. 10 lbs.

ITEM#
SF116E6

Mtl 3/4" x 1/4"
9 1/4" W
28 3/8" H
Wt. 3.3 lbs.

ITEM#
SF88C2

Mtl 3/4" x 1/4"
9 1/4" W
28 3/8" H
Wt. 5.2 lbs.

ITEM#
SF621

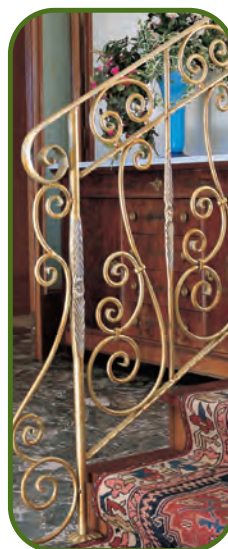

Round

1/2" dia. Rd. Mtl.
9-7/8" W
28-3/8" H
Wt. 3.4 lbs.

ITEM#
SF5401

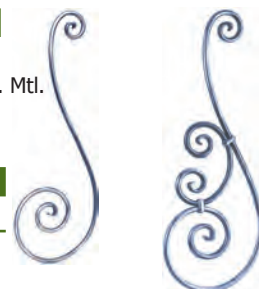

1/2" dia. Rd. Mtl.
9-7/8" W
28-3/8" H
Wt. 5 lbs.

ITEM#
SF5402

Round

9/16" dia. Rd. Matl.
10-1/4" W x 39-1/2" H
Wt. 8.4 lbs.

ITEM#
SF10491

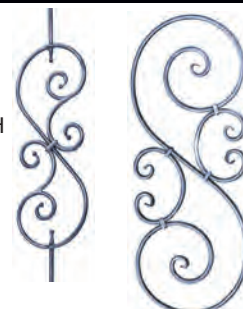

9/16" dia. Rd. Matl.
14-1/2" W
35-7/16" H
Wt. 12 lbs.

ITEM#
SF5412



Also available in 47" H

Mtl 1/2" x 1/4" sq.
7 9/32" W
39 1/2" H
Wt. 4 lbs.

ITEM#
SF52A4S

Mtl 1/2" sq.
5 7/8" W
39 1/2" H
Wt. 4 lbs.

ITEM#
SF10512

Mtl 1/2" sq.
5 7/8" W
39 1/2" H
Wt. 4 lbs.

ITEM#
SF10513

Mtl 1/2" x 1/4"
5 7/8" W
15 3/4" H
Wt. 2.2 lbs.

ITEM#
SF10514

Mtl 1/2" x 1/4"
7 9/32" W
25 5/8" H
Wt. 3.5 lbs.

ITEM#
SF10515

Square

3/8" sq. Mtl.
9-5/8" W
28-3/8" H
Weight: 3.7 lbs.

ITEM #
SF10502



Square

9/16" sq. Mtl.
10-7/16" W
28-3/8" H
Weight: 4.4 lbs.

ITEM #
SF10503





Mtl: 1/2" x 1/4" Width: 94-1/2" **ITEM #**
 Height: 3-15/16" Height: 3-15/16" **SFGD0048**



Mtl: 1/2" Dia. Width: 94-1/2" **ITEM #**
 Height: 5-1/8" Height: 5-1/8" **SFGD0049**



Mtl: 9/16" x 1/4" Width: 96-7/16" **ITEM #**
 Height: 5-7/8" Height: 5-7/8" **SFGD0050**



1/2" sq. material Width: 99-3/16" **ITEM #**
 Height: 3-15/16" Height: 3-15/16" **SFGD0051**



Scroll Panels



Material: 5/8" x 1/4" Rect.
 Width: 6-29/32"
 Height: 20-3/32"
 Weight: 3.52 lbs.

ITEM # **DESCRIPTION**
SFN0016 Scroll Panel



Material: 5/8" x 1/4" Rect.
 Width: 10-1/4"
 Height: 20-9/32"
 Weight: 6.6 lbs.

ITEM # **DESCRIPTION**
SFN0010 Scroll Panel

STEEL PICKETS WITH BASKETS



Twisted 4 filaments basket



Mtl 1/2" sq.
35 7/16" H
Wt. 2.6 lbs.

ITEM#
SF481

Twisted 4 filaments basket



Mtl 1/2" sq.
35 7/16" H
Wt. 2.4 lbs.

ITEM#
SF482



Tree Bark Style

Mtl 1/2" sq.
35-7/16" H
Wt. 2.6 lbs.

ITEM#
SF173317



Mtl 1/2" sq.
35-7/16" H
Wt. 2.5 lbs

ITEM#
SF173318



Hammered 4 filaments basket

Mtl 9/16" sq.
35 7/16" H
Wt. 4 lbs.

ITEM#
SF6414



Hammered 6 filaments basket

Mtl 9/16" sq.
35 7/16" H
Wt. 4 lbs.

ITEM#
SF6415



Hammered 4 filaments basket

Mtl 1/2" sq.
35 7/16" H
Wt. 2.6 lbs.

ITEM#
SF483



Hammered 4 filaments basket

Mtl 1/2" sq.
35 7/16" H
Wt. 2.4 lbs.

ITEM#
SF484







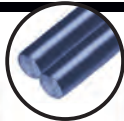



<p>Forged and twisted</p> <p>Also available in 47" H</p> 	<p>Forged and twisted</p> <p>Also available in 47" H</p> 	<p>Forged and twisted</p> <p>Also available in 47" H</p> 	<p>Also available in 47" H</p> <p>Forged and twisted</p> 	 		
<p>Mtl 1/2" sq. 1 3/16" W 35 7/16" H Wt. 2.1 lbs.</p>	<p>Mtl 1/2" sq. 1 3/16" W 35 7/16" H Wt. 2.2 lbs.</p>	<p>Mtl 1/2" sq. 5 1/2" W 35 7/16" H Wt. 2.8 lbs.</p>	<p>Mtl 1/2" sq. 5 1/2" W 35 7/16" H Wt. 3.4 lbs.</p>	<p>Mtl 1/2" sq. 35 7/16" H Wt. 2.5 lbs.</p>	<p>Mtl 1/2" sq. 35 7/16" H Wt. 2.5 lbs.</p>	<p>Mtl 3/4" x 5/32" 4 21/64" W 28 11/32" H Wt. 2.1 lbs.</p>
<p>ITEM# SF505</p>	<p>ITEM# SF506</p>	<p>ITEM# SF507</p>	<p>ITEM# SF508</p>	<p>ITEM# SF118H1</p>	<p>ITEM# SF118H2</p>	<p>ITEM# SF601</p>

Knots Line



Double round 5/8" (= Mtl 5/16")

							
<p>5 7/8" W 35 7/16" H Wt. 2.8 lbs.</p>	<p>4 15/16" W 35 7/16" H Wt. 2.3 lbs.</p>	<p>3 9/16" W 35 7/16" H Wt. 1.8 lbs.</p>	<p>3 9/16" W 35 7/16" H Wt. 1.9 lbs.</p>	<p>4 3/4" W 35 7/16" H Wt. 1.8 lbs.</p>	<p>4 3/4" W 35 7/16" H Wt. 1.9 lbs.</p>	<p>35 7/16" H Wt. 1.7 lbs.</p>	<p>35 7/16" H Wt. 1.77 lbs</p>
<p>ITEM# SF6151</p>	<p>ITEM# SF6153</p>	<p>ITEM# SF6171</p>	<p>ITEM# SF6172</p>	<p>ITEM# SF6173</p>	<p>ITEM# SF6174</p>	<p>ITEM# SF6176</p>	<p>ITEM# SF6177</p>

STEEL BALCONY BALUSTERS



Hammered
on Edges

Mtl 1 9/16"
5/16"
39 1/2" H
Wt. 7.7 lbs.

ITEM#
SF4412



Mtl 9/16" sq.
35 7/16" H
Wt. 3.4 lbs.

ITEM#
SF70D5



Hammered

Mtl 9/16" sq.
2-1/8" W Basket
35-7/16" H
6-11/32" D
Wt. 3.3 lbs.

ITEM#
SF4711



Mtl 9/16" sq.
35 7/16" H
Wt. 3 lbs.

ITEM#
SF4710



These curved components give a balcony "depth", where a straight baluster might present a "flatter" look.



Mtl 3/16" x 1 3/4"
32" H
Wt. 3.1 lbs.

ITEM#
SF5895



Smooth
finish

Mtl 3/16" x 2"
38" H
8" Depth
Wt. 4.7 lbs.

ITEM#
SF4521



Mtl 3/16" x 2"
38" H
10" Depth
Wt. 6.7 lbs.

ITEM#
SF4513



Mtl 3/16" x 1 1/4"
32" H
6" Depth
Wt. 2.6 lbs.

ITEM#
SF12761

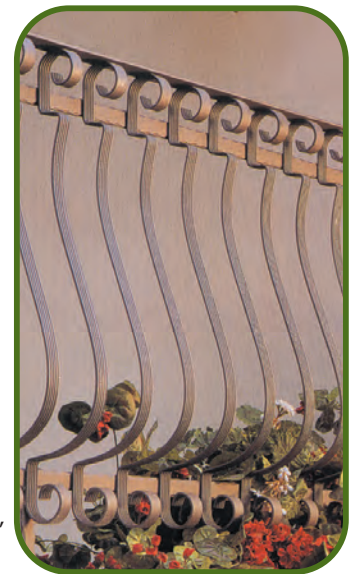



Mtl 1 3/16" x 3/16"
31 1/2" H
Wt. 2 lbs.

ITEM#
SF91205



Mtl 1 3/16" x 3/16"
31 1/2" H
Wt. 1.9 lbs.

ITEM#
SF91204



Mtl 1 3/16" x 3/16"
31 1/2" H
Wt. 1.1 lbs.

ITEM#
SF91203

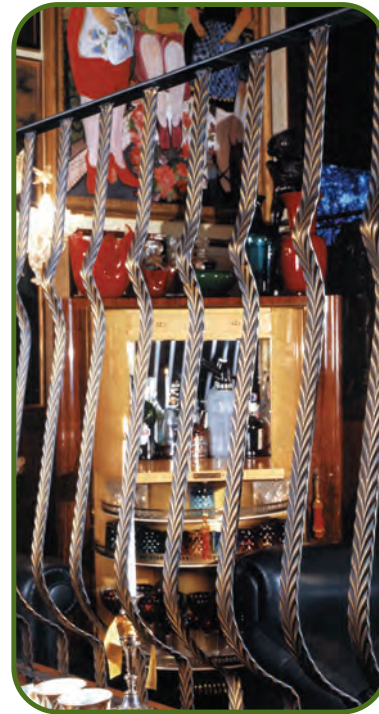

Mtl 1 9/16" x 5/32"
31 1/2" H
Wt. 3.2 lbs.

ITEM#
SF466



STEEL BALCONY BALUSTERS



Twisted

Mtl 9/16" sq.
35 7/16" H
Wt. 3.4 lbs.

ITEM#
SF479



Hammered

Mtl 9/16" sq.
35-7/16" H x 8-11/16" D
Wt. 3.1 lbs.

ITEM#
SF4712



1/2" dia. Round
39-3/8" H
Weight: 3 lbs.

ITEM #
SF17833

Hammered

1/2" sq.
39-3/8" H
Weight: 3 lbs.

ITEM #
SF17835

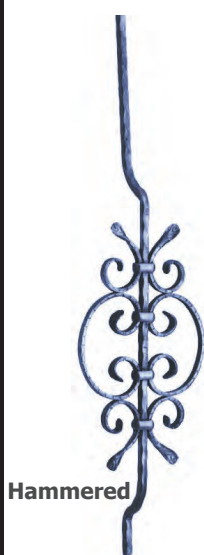

Hammered

Mtl 9/16" sq.
8 7/8" W
35 7/16" H
Wt. 5.5 lbs.

ITEM#
SF64H8



Mtl 9/16" sq.
39 3/8" H
Wt. 3.6 lbs.

ITEM#
SF802722



Mtl 9/16" sq.
39 3/8" H
Wt. 4.1 lbs.

ITEM#
SF91211



Forged Steel Balusters



Mtl 9/16" x 5/16"
6 19/64" W
39 1/2" H
Wt. 6.6 lbs.

ITEM#

SFGD1581



Mtl 9/16" x 5/16"
6 19/64" W
39 1/2" H
Wt. 6.2 lbs.

ITEM#

SFGD1582



Mtl 9/16" x 5/16"
7 1/2" W
39 3/8" H
Wt. 6.8 lbs.

ITEM#

SFGD2282



Mtl: 9/16" dia. Rd.
W: 5-1/8"
Ht: 35-7/16"
Wt. 3 lbs.

ITEM#

SF57815



Hammered

Mtl: 1/2" sq.
W: 5-1/8"
Ht: 47"
Wt: 3.1 lbs.
Hammered

ITEM#

SF57818



Hammered

Mtl 9/16" sq.
1 3/16" W
35 7/16" H
Wt. 3.1 lbs.

ITEM#

SF64H10



HAMMERED STAIR & RAIL BALUSTERS

The 64F series (and other matching components) is one of our most popular lines. The bars are first hammered on all four edges, then the pattern is added to both sides, followed by the addition of scrolls, flowers and baskets.

Hammered

Also available in 47" H



Mtl 9/16" sq.
35 7/16" H
Wt. 3 lbs.

ITEM#
SF64F3

Hammered

Also available in 47" H



Mtl 9/16" sq.
35 7/16" H
Wt. 3 lbs.

ITEM#
SF64F5

Hammered

Also available in 47" H



Mtl 9/16" sq.
5 1/2" W
35 7/16" H
Wt. 3.4 lbs.

ITEM#
SF64F7

Hammered

Also available in 47" H



Mtl 9/16" sq.
4 5/16" W
35 7/16" H
Wt. 4.1 lbs.

ITEM#
SF64F9

Hammered

Also available in 47" H



Mtl 9/16" sq.
35 7/16" H
Wt. 3.1 lbs.

ITEM#
SF5622

Hammered



Mtl 9/16" sq.
8 1/4" W
35 7/16" H
Wt. 4.2 lbs.

ITEM#
SF5616



Mtl 9/16" dia.
Round
7 1/2" W
39 1/2" H
Wt. 3.7 lbs.

ITEM#
SF11361



Mtl 9/16" dia. Rd.
7 7/8" W
39 1/2" H
Wt. 4.6 lbs.

ITEM#
SF11362

Hammered



Mtl 9/16" sq.
8 7/8" W
35 7/16" H
Wt. 5.2 lbs.

ITEM#
SF64G2





Mtl 9/16" dia. Rd.
6 5/8" W
35 7/16" H
Wt. 4 lbs.

ITEM#
SF5772



Mtl 9/16" dia. Rd.
6 5/8" W
35 7/16" H
Wt. 3.6 lbs.

ITEM#
SF5773

AVAILABLE IN
TWO SIZES

Mtl 9/16" dia. Rd.
35 7/16" H
Wt. 2.5 lbs.

ITEM#
SF5762

Mtl 9/16" dia. Rd.
39 1/2" H
Wt. 2.6 lbs.

ITEM#
SF11353

AVAILABLE IN
TWO SIZES

Mtl 9/16" dia. Rd.
35 7/16" H
Wt. 2.5 lbs.

ITEM#
SF5764

Mtl 9/16" dia. Rd.
39 1/2" H
Wt. 2.6 lbs.

ITEM#
SF11354



Also available in 47" H

STAIR & RAIL BALUSTERS



Mtl 1/2" dia.
Rd.
39 1/2" H
Wt. 4 lbs.

ITEM#
SF6046



Mtl 1/2" dia.
Rd.
39 1/2" H
Wt. 3 lbs.

ITEM#
SF6047



Mtl 1/2" dia. Rd.
39 1/2" H
Wt. 3 lbs.

ITEM#
SF6048



Mtl 1/2" dia. Rd.
5 1/8" W
39 1/2" H
Wt. 3.3 lbs.

ITEM#
SF11701



Mtl 1/2" dia. Rd.
4 3/4" W
39 1/2" H
Wt. 4.4 lbs.

ITEM#
SF11711



Mtl 1/2" dia. Rd.
2 3/8" W
39 1/2" H
Wt. 2.2 lbs.

ITEM#
SF11712



Stem 1/8" dia. Rd.
1 1/4" W x 3 1/8" H
Wt. .1 lbs.

ITEM#
SF60412



Thickness 5/64"
1 1/4" W x 1 3/4" H
Wt. .1 lbs.

ITEM#
SF60411



Mtl 1/2" sq.
7 1/16" W
35 7/16" H
Wt. 5.6 lbs.

ITEM#
SF493



Mtl 1/2" sq.
11 13/16" sq.
35 7/16" H
Wt. 4 lbs.

ITEM#
SF513



Also available in 47" H

Mtl 1/2" sq.
4 3/4" W
35 7/16" H
Wt. 4 lbs.

ITEM#
SF603



Hammered

Mtl 1/2" sq.
33 7/16" H
Wt. 1.1 lbs.

ITEM#
SF1032



Hammered

Mtl 1/2" sq.
4 15/16" W
37 7/16" H
Wt. 5.4 lbs.

ITEM#
SF5111



SF6412 AND SF6413 SHOWN HERE



Also available in 47" H

Hammered

Mtl 9/16" sq.
35 7/16" H
Wt.3.6 lbs.

ITEM#

SF6412



Also available in 47" H

Hammered

Mtl 9/16" sq.
35 7/16" H
Wt.3.3 lbs.

ITEM#

SF6413



Also available in 47" H

Mtl 9/16" dia. Rd.
35 7/16" H
Wt.2.3 lbs.

ITEM#

SF64L3



Also available in 47" H

Mtl 9/16" dia. Rd.
35 7/16" H
Wt.2.3 lbs.

ITEM#

SF64L4



Solid brass bushing

Mtl 9/16" dia. Rd.
39 1/2" H
Wt.3.4 lbs.

ITEM#

SF11793



Solid brass bushing

Mtl 9/16" dia. Rd.
39 1/2" H
Wt.4.1 lbs.

ITEM#

SF11794

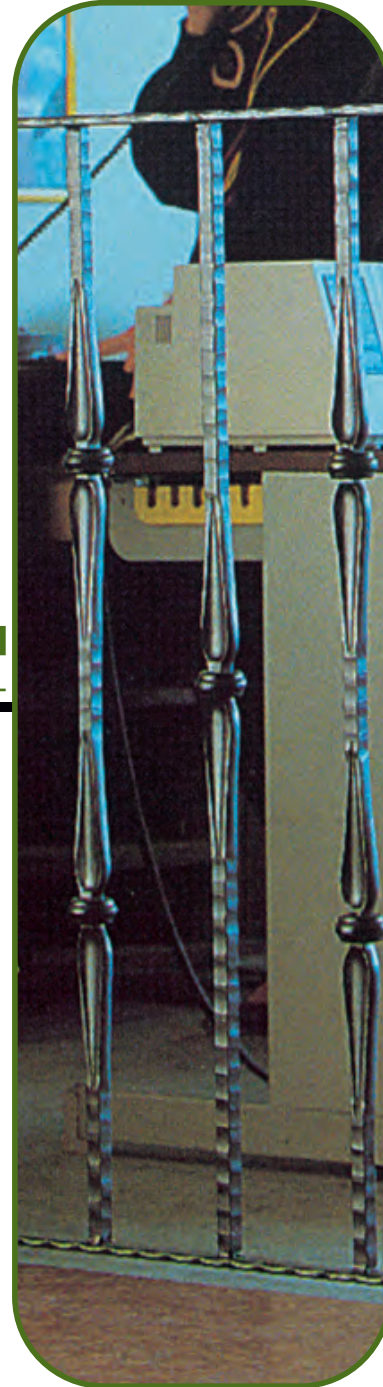

Also available in 47" H

Mtl 9/16" sq.
1-1/4" W
35 7/16" H
Wt.3.1 lbs.

ITEM#

SF70D1



Also available in 47" H

Hammered

Mtl 9/16" sq.
1-1/4" W
35 7/16" H
Wt.3 lbs.

ITEM#

SF5973



Mtl 1/2" sq.
2-9/16" W
35 7/16" H
Wt.2.2 lbs.

ITEM#

SF134G3



Also available in 47" H

Mtl 1/2" sq.
35 7/16" H
Wt.2.5 lbs

ITEM#

SF7555



Also available in 47" H

Mtl 1/2" sq.
35 7/16" H
Wt.2.5 lbs.

ITEM#

SF7556

STAIR & RAIL BALUSTERS

LIMITED QUANTITY
AVAILABLE



Mtl 1/2" sq.
9 7/16" W
39 1/2" H
Wt. 6.1 lbs.

ITEM#
SF11111



Mtl 1/2" sq.
8 1/6" W
39 1/2" H
Wt. 6.0 lbs

ITEM#
SF11112

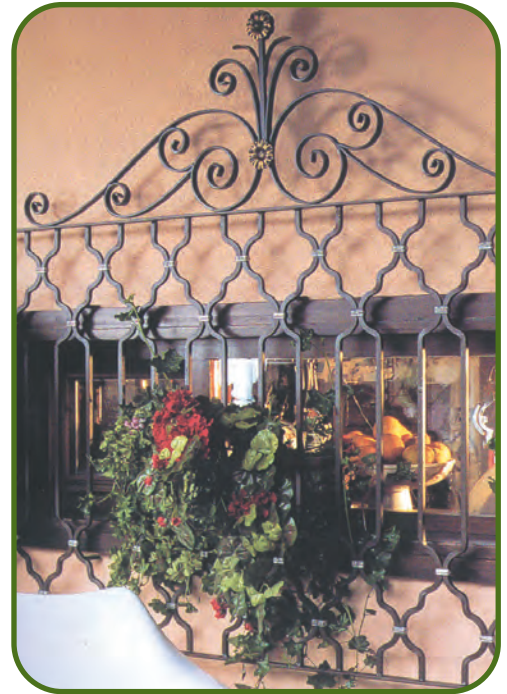

Mtl 1/2" dia. Rd.
39 3/8" H
4 5/16" W
Wt. 3.7 lbs.

ITEM#
SF10713



Mtl 1/2" dia. Rd.
39 3/8" H
4 5/16" W
Wt. 2.8 lbs.

ITEM#
SF10715



Mtl 9/16" x 5/16"
11-1/32" W
39-3/8" H
Weight: 10.3 lbs.

ITEM #

SFG1631



Mtl 9/16" x 5/16"
11-1/32" W
39-3/8" H
Weight: 10.3 lbs.

ITEM #

SFG1632



Mtl 9/16" x 5/16"
11-1/32" W
39-3/8" H
Weight: 8 lbs.

ITEM #

SFG1591



Mtl 9/16" x 5/16"
11-1/32" W
39-3/8" H
Weight: 6.2 lbs.

ITEM #

SFG1592



Mtl 1/2" sq.
5-5/16" W
39-1/2" H
Wt. 3.5 lbs.

ITEM#

SF10911



Mtl 1/2" sq.
5-5/16" W
39 1/2" H
Wt. 4.4 lbs.

ITEM#

SF10912



Mtl 1/2" sq.
3-15/16" W
39-1/2" H
Wt. 2.7 lbs.

ITEM#

SF13255



BALUSTERS & STAIR PANELS



Mtl 1/2" sq.
9 1/16" W x 35 7/16" H
Wt. 7.2 lbs.

ITEM#
SFN4642



Mtl 1/2" sq.
9 1/16" W x 35 7/16" H
Wt. 6.7 lbs.

ITEM#
SFN4641



Mtl 1/2" sq.
9 1/16" W x 35 7/16" H
Wt. 7.2 lbs.

ITEM#
SFN4644



Mtl 1/2" sq.
9 1/16" W x 35 7/16" H
Wt. 6.7 lbs.

ITEM#
SFN4643



Mtl 1/2" dia. Rd.
39 3/8" H
Wt. 2.5 lbs.

ITEM#
SF11671



Mtl 1/2" dia. Rd.
39 3/8" H
Wt. 2.3 lbs.

ITEM#
SF11672

Large Panels



Mtl 1-3/16 x 3/16" sq.
9-1/4" W x 32-1/4" H
Wt. 7 lbs.

ITEM#
SF633

Hammered

Mtl 1/2" sq.
26" W x 26" H
Wt. 23 lbs.

ITEM#
SF4801

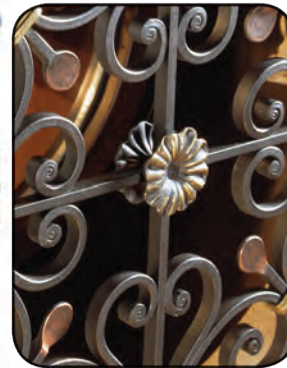
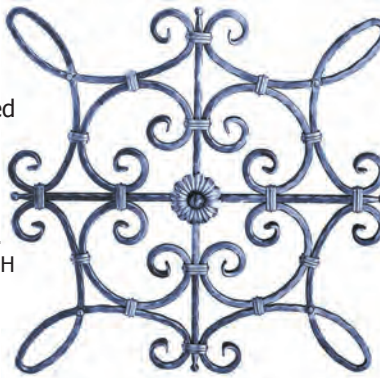

5/8" x 5/16" Matl.
55-3/8" W - approx.
26-3/8" H - approx.
Weight: 34 lbs.

ITEM #
SFG005



Extra Large Scrolls



Hammered Finish

ITEM#
SF6533

Mtl 1/4" x 1 1/4"
9 1/2" W x 59" H

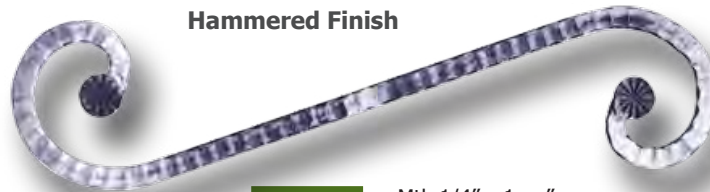

Hammered Finish

ITEM#
SF6534

Mtl 1/4" x 1 1/4"
14 3/16" W x 59" H

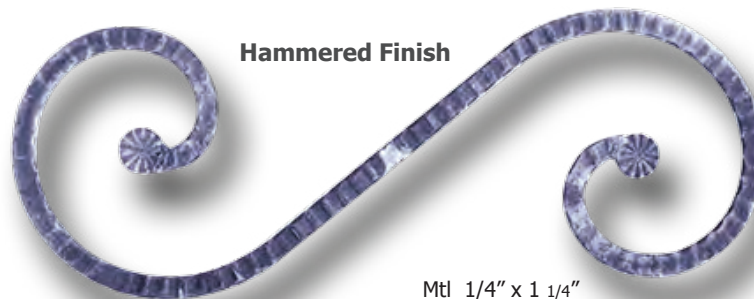

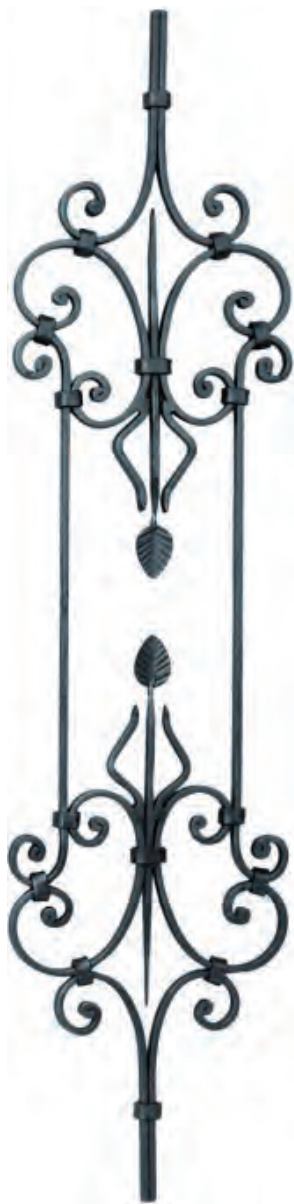

1/2" x 1/4" Matl.
9-9/16" W - approx.
39-3/8" H - approx.
Weight: 7.5 lbs.

ITEM #
SFG0015



5/8" x 5/16" Matl.
9-9/16" W approx.
29-5/16" H approx.
Weight: 12.6 lbs.

ITEM #
SFG009



5/8" x 5/16" Matl.
9-9/16" W approx.
37-7/16" H approx.
Weight: 12.1 lbs.

ITEM #
SFG008



Mtl 1/2" sq.
15 1/8" W x 35-7/16" H
Wt. 10 lbs.

ITEM #
SF4792

Hammered



Mtl 1/2" sq.
15" W x 35-7/16" H
Wt. 12 lbs.

ITEM #
SF4752

Hammered



Enlarged to show detail.

Material: 9/16" sq.
Width: 9-1/16"
Height: 39-1/2"
Weight: 14.5 lbs.

ITEM#
SF91335

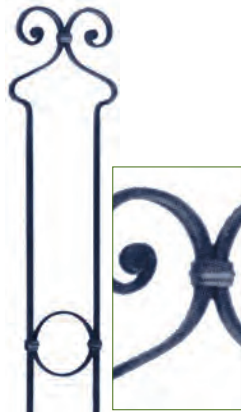

Enlarged to show detail.

Material: 5/16" x 9/16" Rect.
Width: 6-7/8"
Height: 39-1/2"
Weight: 5.5 lbs.

ITEM#
SF16722



Enlarged to show detail.

Material: 5/16" x 9/16" Rect.
Width: 6-7/8"
Height: 39-1/2"
Weight: 5.5 lbs.

ITEM#
SF16721



SF16721
Shown



Hammered

Enlarged to show detail.

Material: 9/16" Sq.
Width: 2-5/32"
Height: 39-3/8"
Weight: 3.36 lbs.

ITEM #
SF4902



Hammered

Enlarged to show detail.

Material: 9/16" Sq.
Width: 2-5/32"
Height: 39-1/2"
Weight: 2.2 lbs.

ITEM #
SF4901

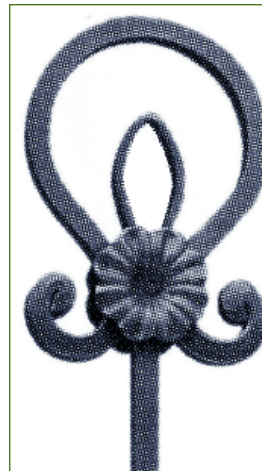

Enlarged to show detail.

Material: 9/16" Sq.
Width: 5-1/2"
Height: 39-1/2"
Weight: 7.7 lbs.

ITEM#
SF91334

HAND FORGED BALUSTERS



Mtl. 9/16" dia. Rd.
39-3/8" H
Wt. 3.1 lbs.

ITEM#

SF11841



Mtl. 9/16" dia. Rd.
39-3/8" H
Wt. 3.4 lbs.

ITEM#

SF11842



Mtl. 1/2" dia. Rd.
39-3/8" H
Wt. 2.2 lbs.

ITEM#

SF11844



Mtl. 9/16" dia. Rd.
39-3/8" H
Wt. 3 lbs.

ITEM#

SF11845



Mtl: 5/8" to 3/8"
dia. Rd.
39-3/8" H
Wt. 2.6 lbs.

ITEM#

SF11846



SF11851
Shown

Hammered



Mtl. 1/2" sq.
39-3/8" H
Wt. 2.2 lbs.

ITEM#

SF11851



Mtl. 39-3/8" H
Wt. 2.4 lbs.
Mtl. tapers to
33/64"

ITEM#

SF11852



Also available in 47" H

Mtl 1/2" dia. Rd.
39-3/8" H
Wt. 1.8 lbs.

ITEM#

SF4991



SF4991
Shown

HAND FORGED BALUSTERS



Also available in 47" H

Hammered

Mtl 1/2" sq.
39 1/2" H
Wt. 3.3 lbs.

ITEM#
SF1051



Also available in 47" H

Hammered

Mtl 1/2" sq.
39 1/2" H
Wt. 3 lbs.

ITEM#
SF1052



Mtl 1/2" dia. Rd.
39 1/2" H
Wt. 2.2 lbs.

ITEM#
SF4971



Mtl 1/2" dia. Rd.
39 1/2" H
Wt. 2.7 lbs.

ITEM#
SF4972



Hammered

Mtl 11/16" sq.
39 1/2" H
Wt. 6.2 lbs.

ITEM#
SF5082



Also available in 47" H

Hammered

Hammered square

Mtl 9/16" sq.
39 1/2" H
Wt. 3.5 lbs.

ITEM#
SF1053



Hammered

Hammered round

Mtl 1/2" dia. Rd.
39 1/2" H approx.
Wt. 2 lbs.

ITEM#
SF11854

Mtl 5/8" sq.
39 1/2" H
Wt. 4 lbs.

ITEM#
SF1054

Mtl 9/16" dia. Rd.
39 1/2" H approx.
Wt. 2.6 lbs.

ITEM#
SF11855



Also available in 47" H

Hammered

Mtl 1/2" dia. Rd.
39 1/2" H
Wt. 2.5 lbs.

ITEM#
SF5002



Mtl 1/2" dia. Rd.
39 1/2" H
Wt. 2.8 lbs.

ITEM#
SF5031



Hammered

Mtl 9/16" sq.
39 1/2" H
Wt. 2.2 lbs.

ITEM#
SF5021



Also available in matching Newel Post.

Hammered

Tapered

Mtl 9/16" sq.
39 1/2" H
Wt. 3.5 lbs.

ITEM#
SF5053



Also available in matching Newel Post.

Hammered

Tapered

Mtl 9/16" sq.
39 1/2" H
Wt. 4.2 lbs.

ITEM#
SF5054

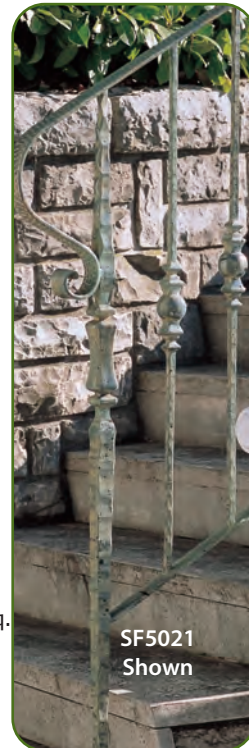

SF5021
Shown

Hand Forged 4-Filament Brass Baskets



Mtl 1/2" sq.
39 1/2" H
Wt. 2.7 lbs.

ITEM#

SF11491



Mtl 1/2" sq.
39 1/2" H
Wt. 2.8 lbs.

ITEM#

SF11492



Mtl 1/2" sq.
39 1/2" H
Wt. 2.7 lbs.

ITEM#

SF11495



Mtl 1/2" sq.
39 1/2" H
Wt. 2.8 lbs.

ITEM#

SF11496

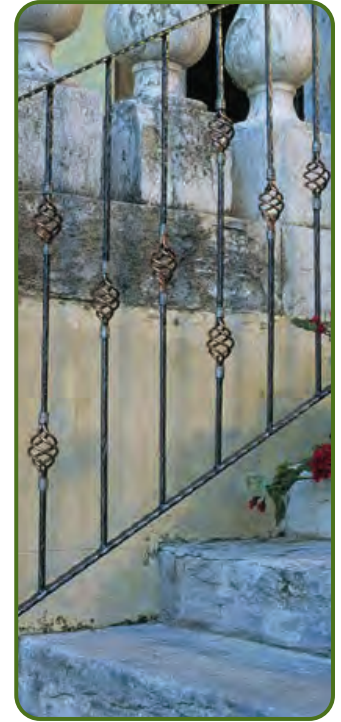

Tubular Steel



Mtl 1-3/16" dia. Rd.
35-7/16" H
Wt. 2 lbs.

ITEM#

SF1481

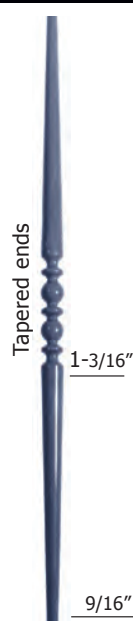

Mtl 1-3/16" dia. Rd.
H 35-7/16" H
Wt. 2.1 lbs.

ITEM#

SF1482



Mtl 1-3/16" dia. Rd.
35 7/16" H
Wt. 2.1 lbs.

ITEM#

SF1491

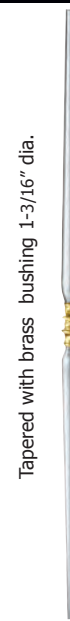

Mtl 1-3/16" dia. Rd.
H 35 7/16"
Wt. 2.2 lbs.

ITEM#

SF1443



Mtl 1-3/16" dia. Rd.
H 36 5/8"
Wt. 2.6 lbs.

ITEM#

SF5251



39 1/2" H
Wt. 4.1 lbs.

ITEM#
SF981



39 1/2" H
Wt. 3.1 lbs.

ITEM#
SF1093



Mtl 1/2" sq.
39-3/8" H
Wt. 3.7 lbs.

ITEM#
SF108A1

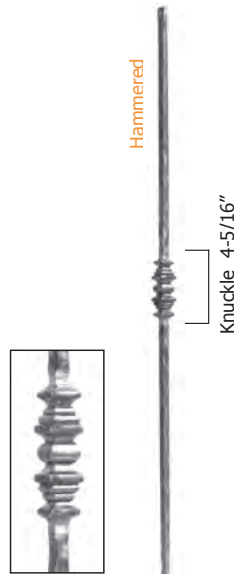

Mtl 1/2" sq.
39-3/8" H
Wt. 3.5 lbs.

ITEM#
SF108A2



Mtl 1/2" sq.
39-3/8" H
Wt. 3.5 lbs.

ITEM#
SF1103

SPECIAL LENGTH STEEL BALUSTERS - 47"



Also available in 35-7/16" H

Mtl 9/16" dia. Rd.
Wt. 3.4 lbs.

ITEM#
SF5762L



Also available in 35-7/16" H

Hammered

Mtl 9/16" sq.
Wt. 4.1 lbs.

ITEM#
SF64F3L



Also available in 35-7/16" H

Hammered

Mtl 9/16" sq."
Wt. 4.1 lbs.

ITEM#
SF64F5L



Hammered

Hammered

Mtl 1/2" sq.
5-1/8" W
47" H
Wt. 3.1 lbs.

ITEM#
SF57818



Also available in 35-7/16" H

Hammered

Mtl 9/16" sq.
Wt. 4.4 lbs.

ITEM#
SF5622L



Also available in 35-7/16" H

Hammered

Mtl 9/16" sq.
4 5/16" W x 47" H
Wt. 5.1 lbs.

ITEM#
SF11575



Also available in 39-1/2" H

Mtl 1/2" x 1/4" sq.
7 1/2" W x 47" H
Wt. 4.8 lbs.

ITEM#
SF52A4SL



Also available in 35-7/16" H

Mtl 1/2" dia. Rd.
4 3/4" W x 47" H
Wt. 5.5 lbs.

ITEM#
SF603L



Also available in 39-1/2" H

Hammered

Mtl 9/16" sq.
Wt. 4.2 lbs.

ITEM#
SF1053L



Also available in 35-7/16" H

Hammered

Mtl 9/16" sq.
1-1/4" W
Wt. 3.3 lbs.

ITEM#
SF5973L



Also available in 35-7/16" H

Mtl 9/16" sq.
1-1/4" W
Wt. 3.0 lbs.

ITEM#
SF70D1L



Also available in 35-7/16" H

Mtl 9/16" dia. Rd.
Wt. 3.2 lbs.

ITEM#
SF64L4L



Also available in 35-7/16" H

Mtl 9/16" dia. Rd.
Wt. 3.2 lbs.

ITEM#
SF64L3L



Also available in 35-7/16" H

Mtl 1/2" sq.
Wt. 3 lbs.

ITEM#
SF7555L



Also available in 35-7/16" H

Mtl 1/2" sq.
Wt. 3.3 lbs.

ITEM#
SF7556L



Also available in 35-7/16" H

Mtl 9/16" sq.
Wt. 4.6 lbs.

ITEM#
SF64I3L



Also available in 35-7/16" H

Hammered

Also available in 35-7/16" H

Also available in 35-7/16" H

Also available in 35-7/16" H

Hammered

Hammered

Also available in 35-7/16" H

Also available in 35-7/16" H

Also available in 35-7/16" H

Also available in 35-7/16" H

Mtl 9/16" sq.
Wt. 4.1 lbs.

Mtl 1/2" sq.
2 1/8" W
Wt. 3.3 lbs.

Mtl 1/2" sq.
2 1/8" W
Wt. 3.2 lbs.

Mtl 1/2" sq.
2 1/8" W
Wt. 3.3 lbs.

Mtl 1/2" sq.
2 1/8" W
Wt. 3.2 lbs.

Mtl 1/2" sq.
Wt. 3 lbs.

Mtl 1/2" sq.
Wt. 3 lbs.

Mtl 1/2" sq.
5 1/2" W
Wt. 3.6 lbs.

Mtl 1/2" sq.
5 1/2" W
Wt. 4.2 lbs.

ITEM#
SF64I2L

ITEM#
SF481L

ITEM#
SF482L

ITEM#
SF483L

ITEM#
SF484L

ITEM#
SF505L

ITEM#
SF506L

ITEM#
SF507L

ITEM#
SF508L

Hand Forged Balusters

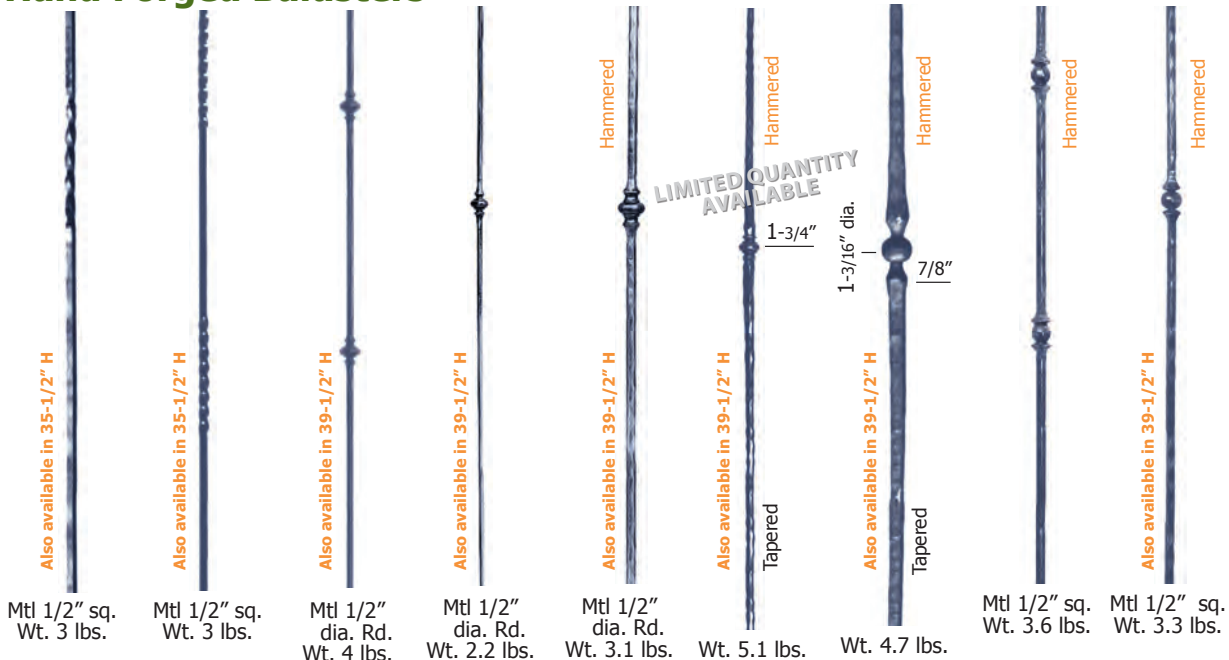

Also available in 35-1/2" H

Also available in 35-1/2" H

Also available in 39-1/2" H

Also available in 39-1/2" H

Hammered

Also available in 39-1/2" H

LIMITED QUANTITY AVAILABLE

Hammered

Also available in 39-1/2" H

Tapered

1-3/4"

1-3/16" dia.

Hammered

Also available in 39-1/2" H

Tapered

7/8"

Hammered

Also available in 39-1/2" H

Hammered

Mtl 1/2" sq.
Wt. 3 lbs.

Mtl 1/2" sq.
Wt. 3 lbs.

Mtl 1/2" dia. Rd.
Wt. 4 lbs.

Mtl 1/2" dia. Rd.
Wt. 2.2 lbs.

Mtl 1/2" dia. Rd.
Wt. 3.1 lbs.

Wt. 5.1 lbs.

Wt. 4.7 lbs.

Mtl 1/2" sq.
Wt. 3.6 lbs.

Mtl 1/2" sq.
Wt. 3.3 lbs.

ITEM#
SF658L

ITEM#
SF533L

ITEM#
SF11592

ITEM#
SF11591

ITEM#
SF5002L

ITEM#
SF11598

ITEM#
SF11597

ITEM#
SF11596

ITEM#
SF11595



Match for SF981

Hammered

Mtl 1" sq. 47" H
Wt. 12.5 lbs.

ITEM#
SF1125



Match for SF1051 and SF1052

Hammered

Mtl 1 9/16" sq.
47" H
Wt. 37.4 lbs.

ITEM#
SF7993

Mtl 1" sq.
47" H
Wt. 14.5 lbs.

ITEM#
SF1127



Match for SF4991

Mtl 1 3/16" dia. Rd.
47" H
Wt. 11.5 lbs.

ITEM#
SF7972

Mtl 1 9/16" dia. Rd.
47" H
Wt. 11.4 lbs.

ITEM#
SF7977



Match for SF1103 and SF1105

Tapered ends
Hammered

Mtl 1 3/16" sq.
47" H
Wt. 14.1 lbs.

ITEM#
SF1129



Match for round balusters SF4971 and SF4972

Hammered

Mtl 1 3/16" sq.
47" H
Wt. 14.3 lbs.

ITEM#
SF11211

Newel Posts



Match for SF6413 and SF6414

Hammered

Mtl 1" sq.
H 47"
Wt. 14.7 lbs.

ITEM#
SF6411



Match for SF505 - SF506 - SF507 - SF508

Mtl 3/4" sq.
H 43-1/4"
Wt. 8.4 lbs.

ITEM#
SF1135

Mtl 1-3/16" sq.
H 43 1/4"
Wt. 17 lbs.

ITEM#
SF1136



Match for twisted bars
10 3/4" Twist

Mtl 3/4" sq.
H 47"
Wt. 13 lbs.

ITEM#
SF1137

Mtl 1 3/16" sq. H 47"
Wt. 15 lbs.

ITEM#
SF1138



Mtl 1" sq.
47" H
Wt. 14 lbs.

ITEM#
SF1123



Match for SF64F3 - SF64F5 - SF64F7 - SF64F9 - SF64G2

Hammered

Mtl 1" sq.
H 47"
Wt. 13 lbs.

ITEM#
SF64F1



Match SF5761 and SF5762

Mtl 1" dia. Rd.
H 47"
Wt. 11 lbs.

ITEM#
SF8015



Mtl 1 3/16" sq.
13 3/4" W x 39 1/2" H
Wt. 37.8 lbs.

ITEM#
SF8021



Mtl 1" x 1/2"
10 5/8" W x 25 5/8" H
Wt. 15.8 lbs.

ITEM#
SF8022



Match for SF481 - SF482

SF1131 = basket SF1596 SF1132 = basket SF1599

Mtl 3/4" sq. 43 1/4" H
Wt. 8 lbs.

ITEM#
SF1131

Hammered



Match for SF483 - SF484

SF1131 = basket SF159 SF1134 = basket SF1599

Mtl 3/4" sq. 43 1/4" H
Wt. 8 lbs.

ITEM#
SF1133

Match for SF4621 - SF4622



Mtl 1 3/16" dia. Rd.
43 1/4" H
Wt. 11 lbs.

ITEM#
SF8014

Match for SF11445 - SF11446



Brass basket

Mtl 3/4" sq.
47" H
Wt. 8.1 lbs

ITEM#
SF11497

Match for SF11511 - SF11512



LIMITED QUANTITY AVAILABLE

Mtl 15/16" dia. Rd.
47" H
Wt. 7.7 lbs

ITEM#
SF12032

Steel tube with solid brass bushing 2.15/16" dia.



Mtl 1 9/16" dia. Rd.
39 3/8" H
Wt. 5.5 lbs.

ITEM#
SF1453

Mtl 1 3/16" sq. 43 1/4" H
Wt. 17.6 lbs.

ITEM#
SF1132

Mtl 1 3/16" sq. 43 1/4" H
Wt. 20 lbs.

ITEM#
SF1134



Enlarged to show detail.



Material: 1-3/16" Sq.
Width: 10-5/8"
Height: 47"
Weight: 24.2 lbs.

ITEM #
SF12061



Enlarged to show detail.



Hammered

Matches Balusters
SF5053 and SF5054

Material: 1" Square
Height: 43-5/16"
Weight: 17.16 lbs.

ITEM #
SF7991



Enlarged to show detail



Material: 3/4" Sq.
Height: 42"
Weight: 8.0 lbs.

ITEM #
SF112B9



Mtl 1" sq.
47" H
Wt. 13 lbs.

ITEM#
SF91472

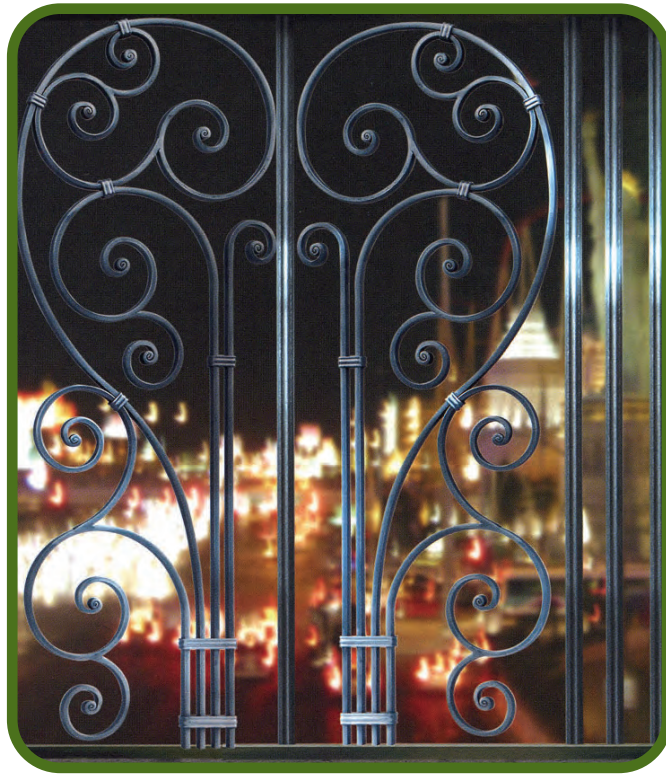

Left



Right

Mtl 9/16" x 5/16"
H 40" W 15" Wt. 14.1 lbs.

ITEM#
SFG1641

Mtl 9/16" x 5/16"
H 40" W 15" Wt. 14.1 lbs.

ITEM#
SFG1642

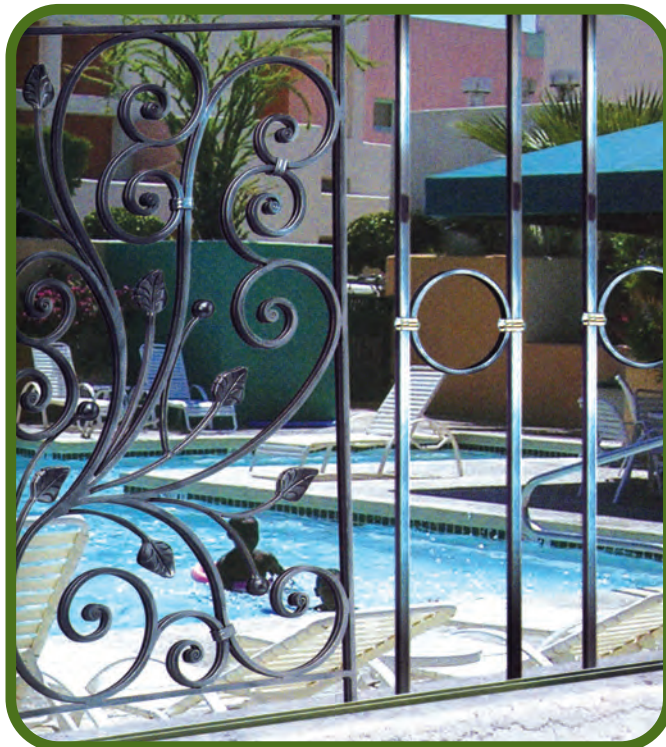

Mtl 9/16" x 5/16"
H 40" W 19-11/16"
Wt. 20.9 lbs.

ITEM#
SFG2222



Mtl 9/16" x 5/16"
H 40" W 10-27/32"
Wt. 12.3 lbs.

ITEM#
SFG2231

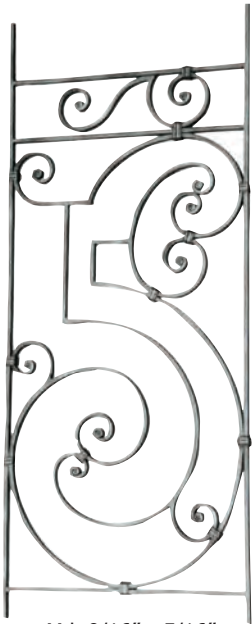

Mtl 9/16" x 5/16"
H 40" W 16 17/32"
Wt. 17.4 lbs.

ITEM#

SFG2061



Mtl 9/16" x 5/16"
H 40" W 17 11/32" Wt. 13.2 lbs.

ITEM#

SFG2091



Mtl 9/16" x 5/16"
H 40" W 19 3/32" Wt. 21.6 lbs.

ITEM#

SFG2062



Mtl 9/16" x 5/16"
H 40" W 9 1/2" Wt. 11.2 lbs.

ITEM#

SFG2162





Mtl 9/16" x 5/16"
 Height: 40" Width: 38-7/32" Weight: 40.8 lbs.

*Rosettes on front
 and back*

ITEM#
 SFG2361

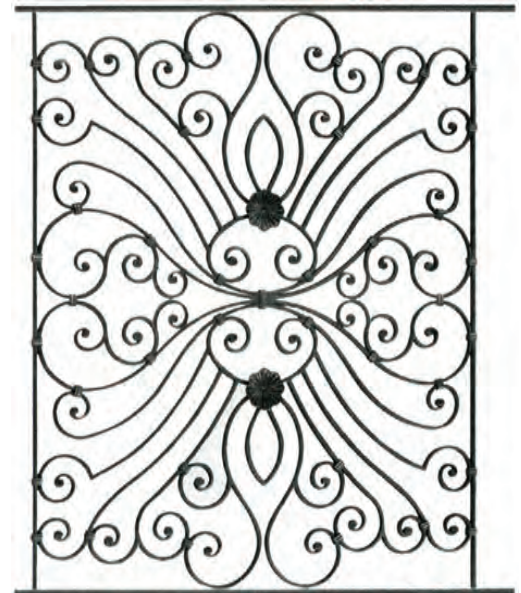

Mtl 9/16" x 5/16"
 Height: 46-3/4" Width: 39-1/2" Weight: 55.1 lbs.

*Rosettes on front
 and back*

ITEM#
 SFG2391

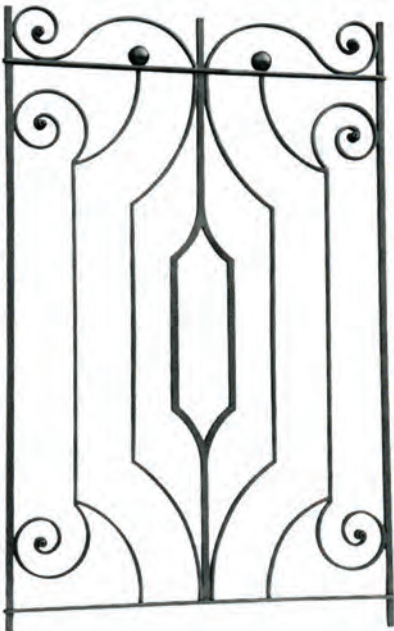

Mtl: 1/2" sq. Scrolls: 9/16" x 5/16"
 H: 40" W: 25-7/32" Wt.: 20.5 lbs.

ITEM#
SFG2421



Mtl 1/2"
 H 40" W 4 11/32"
 Wt. 4.6 lbs.

ITEM#
SFG2432



Mtl 1/2" sq.
 H 40" W 16 11/32"
 Wt. 20.9 lbs.

ITEM#
SFG2412



Mtl 9/16" x 5/16"
 H 40" W 15 9/16"
 Wt. 17.8 lbs.

ITEM#
SFG2202



FORGED RAIL PANELS



Mtl 5/16" x 5/8"
31-13/16" W
39-3/8" H
Wt. 18.4 lbs.

ITEM#
SFGD3023

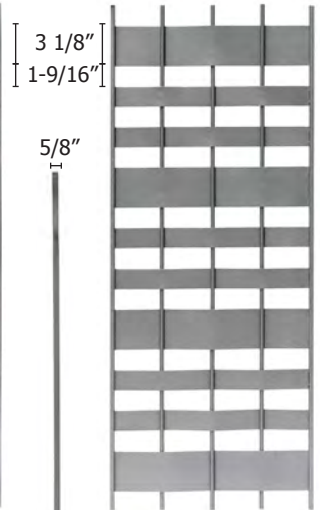

Mtl 5/16" x 5/8"
16-1/16" W
39-3/8" H
Wt. 11 lbs.

ITEM#
SFGD3033



Mtl 1/2" dia. rd.
H 40" W 11 7/16"
Wt. 13.7 lbs.

ITEM#
SFG2551



Mtl 1/2" dia. rd.
H 40" W 5 29/32"
Wt. 7.1 lbs.

ITEM#
SFG2552



Mtl 5/8" x 5/16" sq.
 24 1/64" W
 36 39/64" H
 Wt. 36.8 lbs.

ITEM#
SFGD0012



Mtl 5/8" x 5/16" sq.
 28 47/64" W
 30 5/16" H
 Wt. 34.2 lbs.

ITEM#
SFG007



Mtl 5/8" x 5/16" sq.
 25 13/64" W
 37 7/16" H
 Wt. 37.5 lbs.

ITEM#
SFG0019



FORGED RAIL PANELS



1/2" sq. Mtl.
16-1/2" W
39-3/8" H
Weight: 21.6 lbs.

ITEM #

SFG2121



1/2" x 5/16" Mtl.
7-1/2" W
38-3/8" H
Weight: 8.6 lbs.

ITEM #

SFG1891



1/2" x 5/16" Mtl.
13-3/8" W
39-3/8" H
Weight: 16.8 lbs.

ITEM #

SFG1892

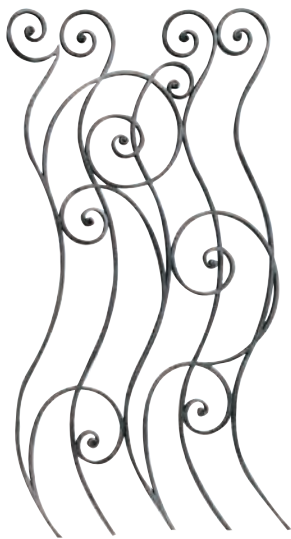
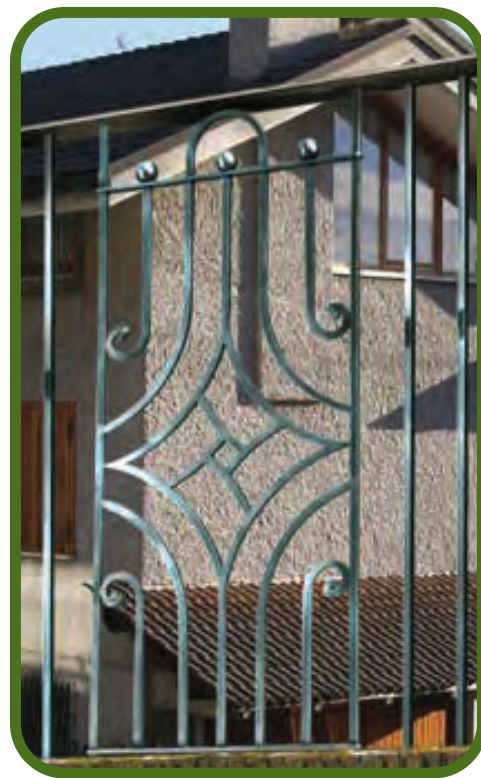

1/2" x 5/16" Mtl.
21-1/16" W
39-3/8" H
Weight: 19.2 lbs.

ITEM #

SFG2263



1/2" x 5/16" Mtl.
4-5/16" W
39-3/8" H
Weight: 2.6 lbs.

ITEM #

SFG2264



1/2" x 5/16" Mtl.
4-5/16" W
39-3/8" H
Weight: 2.2 lbs.

ITEM #

SFG2262

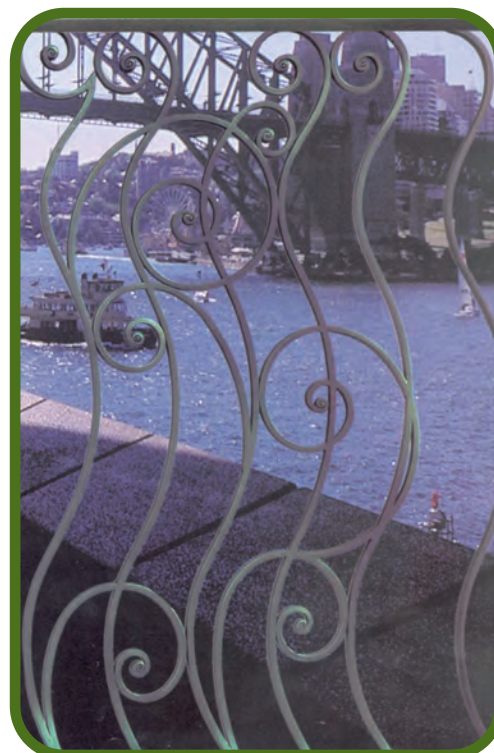

Small Art Deco Panel

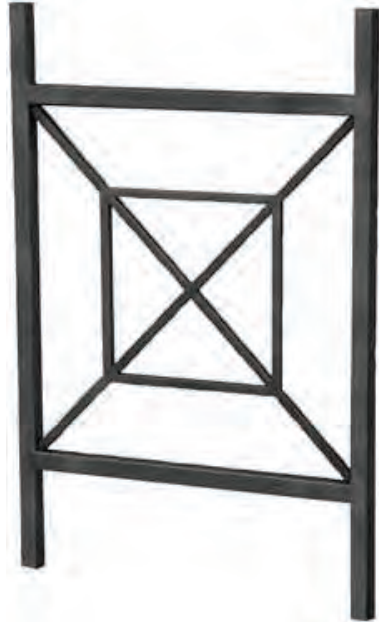

Material: 1" Square
Height: 27-9/16"

Width: 19-11/16"
Weight: 15.4 lbs.

ITEM #	DESCRIPTION
SFGD762	Small Art Deco Panel

Large Art Deco Panel



Material: 1" Square
Height: 39-3/8"

Width: 19-11/16"
Weight: 23.1 lbs.

ITEM #	DESCRIPTION
SFGD761	Large Art Deco Panel

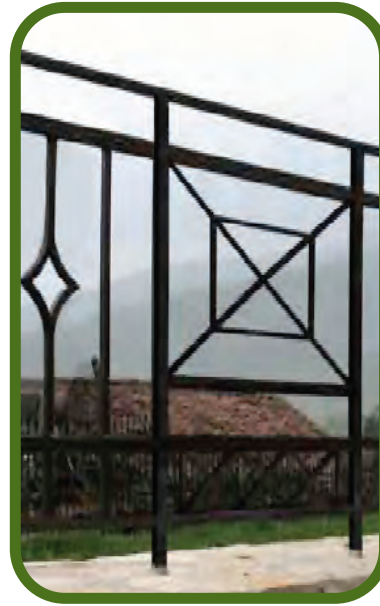

Angled Scroll Panel

For use on
inclines



Material: 9/16" x 5/16" Rect.
Width: 13"
Height: 39-3/8"
Weight: 14.3 lbs.

ITEM #	DESCRIPTION
SFGD2452	Angled Scroll Panel

Scroll Panel



Material: 9/16" x 5/16" Rect.
Width: 13"
Height: 39-3/8"
Weight: 13.6 lbs.

ITEM #	DESCRIPTION
SFGD2451	Scroll Panel

STAINLESS STEEL CABLE RAILING SYSTEM

303/304 STAINLESS STEEL - For Interior Use | 316 STAINLESS STEEL - For Exterior Use

Stainless Steel Cable and Accessories

Outdoor Rated

Stainless Steel Wire Rope

Wire Rope 1 X 19



Rigid 316 Stainless
Used for Long, Straight Runs

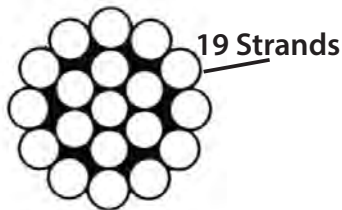

ITEM #	DIA	ROPE
SFEF1X1904	4 MM	5/32"
SFEF1X1905	5 MM	13/64"

Actual Size
5/32"



Actual Size
13/64"



Outdoor Rated

Wire Rope 7 X 7



Flexible 316 Stainless
Perfect for Corners & Angles

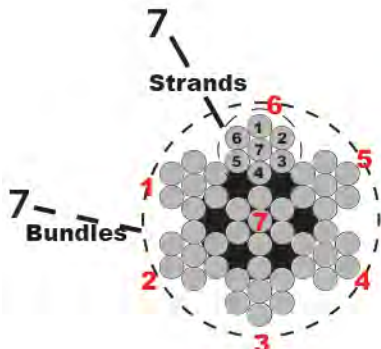

7 strands of stainless steel wire wrapped to form 7 stainless steel bundles

ITEM #	DIA	ROPE
SFEF7X704	4 MM	5/32"
SFEF7X705	5 MM	13/64"

Actual Size
5/32"



Actual Size
13/64"



Finial Hex Head Nut



» Used to end the cable run at post

ITEM #	DESCRIPTION	THREAD
SFED06	Right	6mm 1/4"
SFED06SX	Left	6mm 1/4"

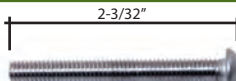

Hex Key Head Screw

» Right hand threaded 316 Stainless
» Used to end the cable run at post - rounded head

ITEM #	DESCRIPTION	LENGTH	THREAD
SFED07	Right	2"	6mm
SFED07SX	Left	2"	6mm

Sloping Washer

» For threaded terminals
» 30° slope
» 304 stainless steel



ITEM #	FOR TUBE	HOLE
SFEB061	1.66"	17/64"
SFEB071	1.66"	11/32"

Wire Sleeve Fitting



ITEM #	ROPE	TUBE
SFESF051	Round Post 13/64"	1-2/3"
SFESF083	Square Post 13/64"	1-2/3"

Turnbuckle Coupling Nut



» Internally threaded - left hand threads on one side, right hand thread on other
» Used to join cable runs

ITEM #	LENGTH	DIA.	THREAD
SFET06	2-1/2"	3/8"	6mm

Lag Screw & M6 Male Dowel Screw

316 Stainless

3" Total Length



ITEM #	DESCRIPTION
SFETW05DX	Right Hand Thread
SFETW05SX	Left Hand Thread

Lag Bracket - Threaded

316 Stainless

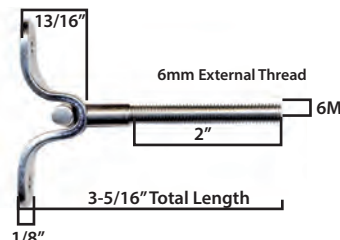

ITEM #	DESCRIPTION
SFEMMF06DX	Right Hand Thread
SFEMMF06SX	Left Hand Thread

Lag Bracket - Crimp

316 Stainless

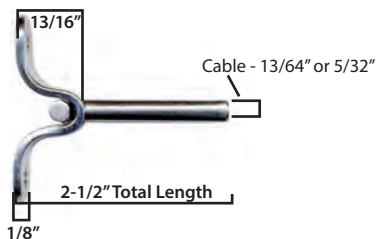

ITEM #	LENGTH	ROPE DIA.
SFEMM05	2-1/2"	13/64"
SFEMM04	2-1/2"	5/32"

Terminal Sleeve Fitting

303 Stainless

» Round Post 1-2/3" Tube
» Rope 5/32" - 13/64"
» 7/8" external dia.

ITEM #	DESCRIPTION
SFEST041DX	Right
SFEST041SX	Left

Swageless Male Threaded Terminal For 5M Wire Rope

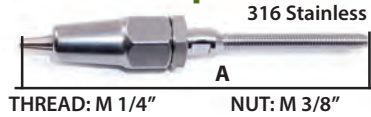

ITEM #	ROPE	A
SFETSM10	13/64"	4-11/64"

Dome Head Crimp Terminal For 5M Wire Rope

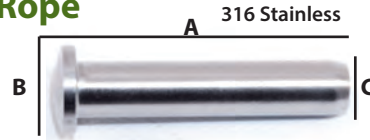

ITEM #	ROPE	A	B	C
SFETTB05	13/64"	1-9/16"	1/2"	5/16"

Threaded Terminals 6 mm Internal and External Threads

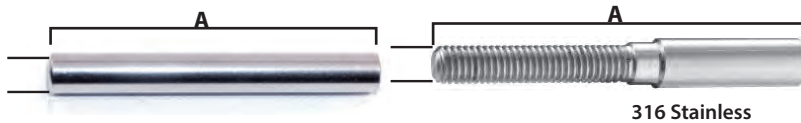

For Cable

» Internal & external threaded options » Used to end cable runs at the or turnbuckle

ITEM #	TYPE		ROPE	A	THREAD
SFETF04DX	Internal	RH	4mm 5/32"dia	2-23/64"	6 mm
SFETM04DX	External	RH	4mm 5/32"dia	2-23/64"	6 mm
SFETF04SX	Internal	LH	4mm 5/32"dia	2-23/64"	6 mm
SFETM04SX	External	LH	4mm 5/32"dia	2-23/64"	6 mm
SFETF05DX	Internal	RH	5mm 13/64"dia	2-23/64"	6 mm
SFETM05DX	External	RH	5mm 13/64"dia	2-23/64"	6 mm
SFETF05SX	Internal	LH	5mm 13/64"dia	2-23/64"	6 mm
SFETM05SX	External	LH	5mm 13/64"dia	2-23/64"	6 mm

Adjustable Cable with 1/4" Threads

» Allows for adjustment at any angle

ITEM #
SFED05316



316 Stainless



GLASS & U-CHANNEL RAILING SYSTEM Available By Special Order

(WITH STEEL WELDING TABS)

Large Lions

Sold as a Pair

H. 30" W. 14-3/4"
WT. 16 lbs. PAIR
Single Faced

ITEM#
AC1000Y

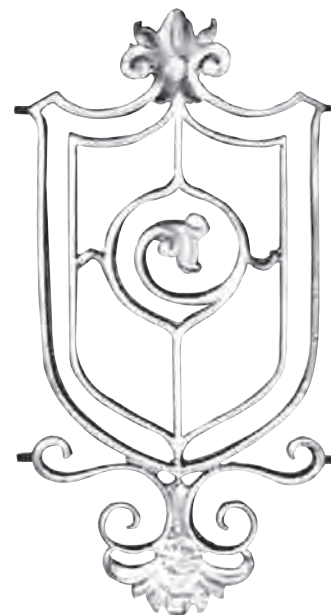
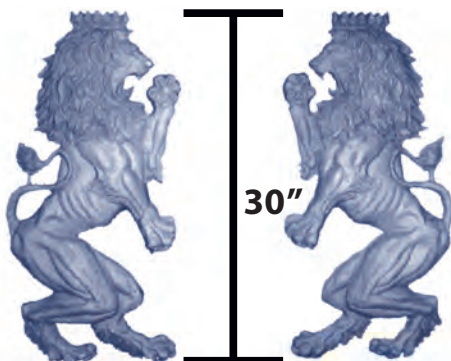

H. 23-1/4"
W. 11-1/2"
WT. 2.125 lbs.
Double Faced

ITEM#
AC136

Medium Lions

Sold as a Pair

H: 11"
W: 8-1/2"
WT. 4 lbs. PAIR
Single Faced

ITEM#
AC605

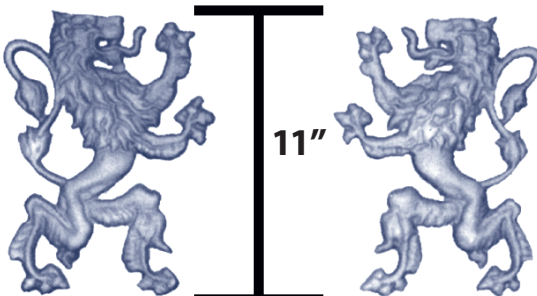

H. 14-5/8"
W. 6-7/8"
WT. 0.75 lbs.
Single Faced

ITEM#
AC1

Two Sizes Available
1/2 of 3/4
Picket

H. 16-7/8"
W. 7-3/4"
WT. 0.808 lbs.
For 1/2" picket
Single Faced

ITEM#
AC2 1/2" Picket

ITEM#
AC234 3/4" Picket



H. 15-1/8"
W. 5-7/8"
WT. 0.50 lbs.
Double Faced

ITEM#
AC15

(WITH STEEL WELDING TABS)



H. 14-1/2"
W. 7-3/4"
WT. 0.75 lbs.
Single Faced

ITEM#
AC4



H. 13-1/4"
W. 7-1/4"
WT. 0.75 lbs.
Single Faced

ITEM#
AC3

Rose



H. 16-1/4"
W. 7-1/4"
WT. 1.50 lbs.
Double Faced

ITEM#
AC22



H. 6-1/8"
W. 7-3/4"
WT. 0.50 lbs.
Single Faced

ITEM#
AC9

H. 3-3/4"
W. 3-3/4"
WT. 0.25 lbs.
Single Faced

ITEM#
AC10A



For 3/4" picket
Single Faced

ITEM#
AC10A34



H. 13"
W. 6-3/4"
WT. 0.75 lbs.
Single Faced

ITEM#
AC12

Find a
Selection of
Aluminum

- **Handrails**
- **Collars**
- **Post Caps**

on Page 99



H. 8-5/8"
W. 4-3/4"
WT. 1.50 lbs.
Single Faced

ITEM#
AC14



ALUMINUM ORNAMENTAL CASTINGS

(WITH STEEL WELDING TABS)

**FORGED
STEEL
TUBULAR
SCROLLS**

LIGHTWEIGHT

Each Scroll is a
Hollow Steel Tube



**NOW STOCKING
PAGES 126-127**



H. 18-1/4"
W. 7"
WT. 1.25 lbs.
Single Faced

ITEM#
AC17



H. 15"
W. 7-1/2"
WT. 2.75 lbs.
Double Faced

ITEM#
AC21



H. 18-1/4"
W. 7"
WT. 1.50 lbs.
Single Faced

ITEM#
AC18



H. 15-5/8"
W. 7"
WT. 0.75 lbs.
Double Faced

ITEM#
AC20

Curly Oak



H. 27-1/4"
W. 11
WT. 5.00 lbs.
Single Faced
Backed Out

ITEM#
AC270

(WITH STEEL WELDING TABS)

Anthemion Crown

H. 10-1/2"
W. 22-1/4"
WT. 3.25 lbs.
Single Faced

ITEM#
AC308



Grape or Vineyard

H. 15-5/8"
W. 7-1/4"
WT. 1.50 lbs.
Double Faced

ITEM#
AC23N



Security Storm Door Castings

H. 13-1/2"
W. 7-3/8"
WT. 1.50 lbs.
Single Faced

ITEM#
AC31



H. 5-1/4"
W. 30-7/8"
WT. 2.00 lbs.
Double Faced

ITEM#
ACM13



H. 4"
W. 30-7/8"
WT. 2.25 lbs.
Double Faced

ITEM#
ACM11

Birds of Paradise

H. 19"
W. 9-1/2"
WT. 2.75 lbs.
Single Faced

ITEM#
AC801



H. 24"
W. 9"
WT. 4.00 lbs.
Double Faced

ITEM#
AC584



H. 26"
W. 9"
WT. 5.60 lbs.
Double Faced

ITEM#
AC585



Pontalba Corner Brackets



17" W x 17" H
7.75 lbs.

ITEM#
CI60

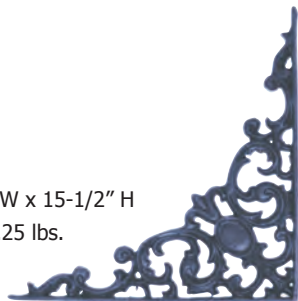

15-1/2" W x 15-1/2" H
7.25 lbs.

ITEM#
CI4030

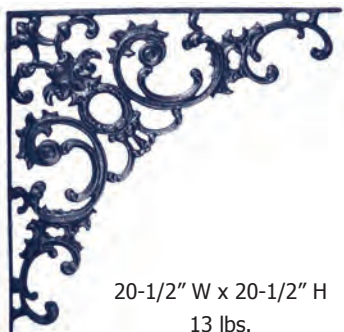

20-1/2" W x 20-1/2" H
13 lbs.

ITEM#
CI80B

**VISIT OUR
ONLINE
CATALOG AT**

WWW.STEELMARTATLANTA.COM



Pontalba



23" W x 6" H
6 lbs.

ITEM#
CI4010

Pontalba - Valance Or Door Trim

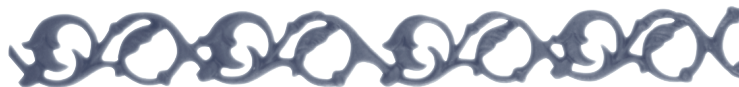

3-1/2" H x 30-5/8" W 6.8 lbs.

ITEM#
CI4020



8-1/4" W x 28-1/2" H
10.68 lbs.

ITEM#
CI4050

Pontalba



7" W x 19-1/2" H
6.5 lbs.

ITEM#
CI65F



7-3/8" W x 28" H
9.25 lbs.

ITEM#
CI65X

Rose



8-5/8" W x 28-1/4" H
10.5 lbs

ITEM#
CI1510

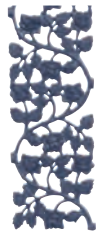

7-7/8" W x 27" H
10.3 lbs

ITEM#
CI1530



9" W x 14-1/2" H
5.4 lbs

ITEM#
CI1540



18" W x 18" H 8.0 lbs

ITEM#
CI1520

Ivy Leaf



19" W x 4-3/4" H
3.5 lbs.

ITEM#
CI850



8-1/2" W x 15-3/4" H
3.5 lbs.

ITEM#
CI858



12-1/2" W x 7-1/4" H
2.5 lbs.

ITEM#
CI852XS

Ivy Leaf



8-3/4" W x 33-1/4" H
12.5 lbs.

ITEM#
CI8661



8-1/4" W x 31" H
9.25 lbs.

ITEM#
CI856



8" W x 19-1/4" H
5.25 lbs.

ITEM#
CI854

Sunflower Design



8" W x 28" H
9.5 lbs

ITEM#
CI98



16" W x 16" H
8 lbs

ITEM#
CI98C



14" W x 14" H 6 lbs

ITEM#
CI98B

Fits 1/2"
Pickets

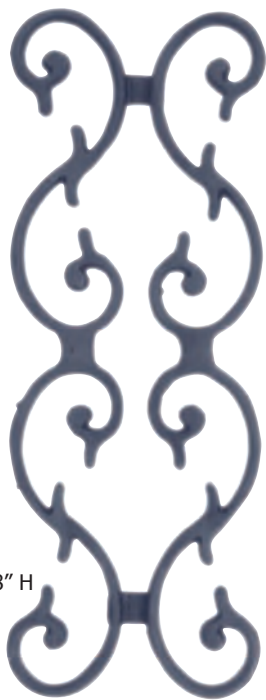

7" W x 18" H
3.3 lbs

ITEM#
CI6070

Fits 1/2" Pickets



8-3/4" W x 16-3/4" H
4.25 lbs

ITEM#
CI6020

Fits 1/2" Pickets



5-3/4" W x 15" H
3.5 lbs

ITEM#
CI6080

Fits 1/2" Pickets



6-3/4" W x 17" H
2.75 lbs

ITEM#
CI6090

Fits 1/2" Pickets



8-1/4" W x 15-1/2" H
.3.3 lbs

ITEM#
CI6030

Fits 1/2" Pickets



8-1/4" W x 6-1/2" H
2.0 lbs

ITEM#
CI6050

Fits 1/2" Pickets



3" W x 8" H
1.1 lbs

ITEM#
CI6040

Fits 1/2" Pickets



8-5/6" W x 10-5/16" H
2.14 lbs

ITEM#
CI6025

Fits 1/2" Pickets



6-1/4" W x 7-3/4" H
1.63 lbs

ITEM#
CI6065

Fits 1/2" Pickets



7-1/2" W x 13-1/2" H
2.3 lbs

ITEM#
CI3

Fits 1/2" Pickets



7-3/4" W x 17-1/2" H
5.5 lbs

ITEM#
CI22

Fits 1/2" Pickets



7" W x 14-1/2" H
3.2 lbs

ITEM#
CI1

Fits 1/2" Pickets



8-1/4" W x 16-1/4" H
5.5 lbs

ITEM#
CI21

Fits 1/2" Pickets



7-1/2" W x 16-1/2" H
4.8 lbs

ITEM#
CI23

Fits 1/2" Pickets



13-1/2" H x 6-5/8" W
1.8 lbs

ITEM#
CI12

Fits 1/2" Pickets

◆ Diamond Shaped
Full Bodied



12-1/2" H x 6-1/2" W
2.25 lbs

ITEM#
CI146

Fits 1/2" or 3/4" Pickets



17-1/2" H x 8" W
2.5 lbs

Fits 3/4" pickets
ITEM#
CI641XLF

Fits 1/2" pickets
ITEM#
CI2

Fits 1/2" Pickets

◆ Diamond Shaped
Full Bodied



18" H x 8-1/2" W
4.0 lbs

ITEM#
CI147

Fits 1/2" Pickets



3-3/4" W x 3-3/4" H
.5 lbs

ITEM#
CI10A

Fits 3/4" Pickets



4" W x 3-3/4" H
.6 lbs

ITEM#
CI10A34

Fits 1/2" Pickets



15-1/2" H x 8-1/4" W
6 lbs.

ITEM#
CI60X

4" H x 5-1/4" W
.64 lbs

ITEM#
CI907

Fits 1/2" Pickets

◆ Diamond Shaped
Full Bodied



4" H x 5-1/4" W
1.0 lbs

ITEM#
CI147XS

Birds of Paradise



8-1/8" W x 24-3/4" H
13 lbs.

ITEM#
CI3530



8-1/2" W x 22" H
11 lbs.

ITEM#
CI3520

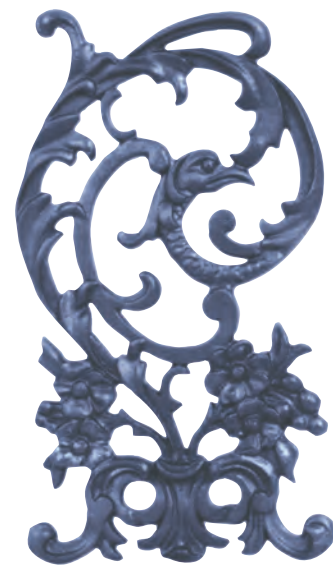

8-1/2" W x 15-1/2" H
8.25 lbs.

ITEM#
CI3510

**PRICING AVAILABLE BY
CALLING
ONE OF OUR LOCATIONS**

TUCKER:

770-416-6999

GAINESVILLE:

770-297-6675

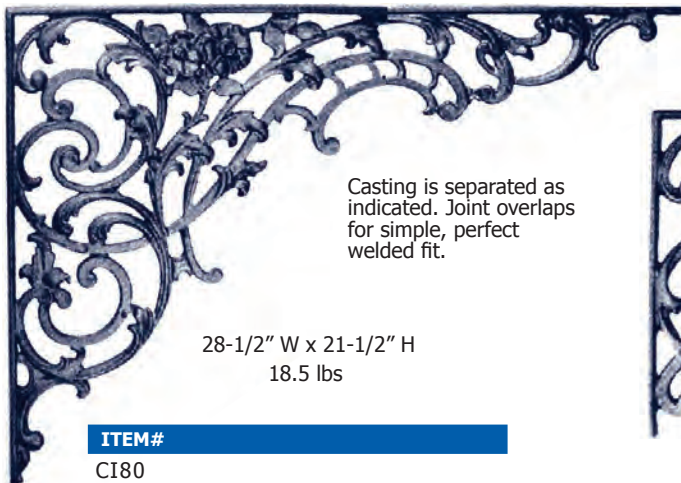

28-1/2" W x 21-1/2" H
18.5 lbs

ITEM#
CI80

Casting is separated as indicated. Joint overlaps for simple, perfect welded fit.

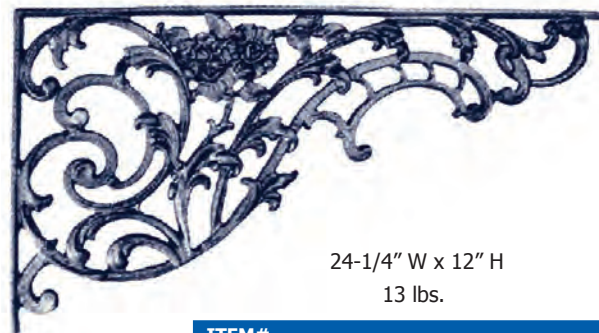

24-1/4" W x 12" H
13 lbs.

ITEM#
CI80A

Passion Flower



Single Faced
Backed Out
8-1/2" W x 19-3/4" H
6.25 lbs

ITEM#
CI4520



6-3/4" W x 24-1/2" H
6.7 lbs

ITEM#
CI4530



Single Faced Backed Out
12" W x 27-1/4" H
15.65 lbs

ITEM#
CI4510

Vineyard Design

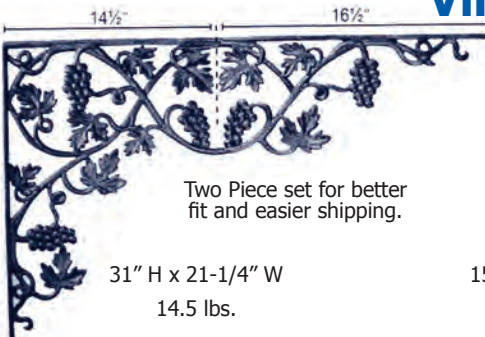

Two Piece set for better
fit and easier shipping.

31" H x 21-1/4" W
14.5 lbs.

ITEM#
CI18



15-1/2" H x 15-1/2" W
5 lbs.

ITEM#
CI10AF

Valance



ITEM#
CI13

29" W x 7-3/4" H
9.75 lbs



7-3/4" W x 29" H
8.5 lbs

ITEM#
CI17

Curly Oak



11-1/2" W x 28" H
13.75 lbs.

ITEM#
CI23F

Curly Oak



2-1/2" H X 20-1/4" W
4.25 lbs.

ITEM#
CI24



4-1/4" H X 23" W
5.75 lbs.

ITEM#
CI27A

8" W x 20-1/4" H
6.25 lbs.

ITEM#
CI2520



8" W x 11" H
4 lbs.

ITEM#
CI26

Curly Oak - Corner Brackets



16" W x 16" H
8.25 lbs.

ITEM#
CI23A

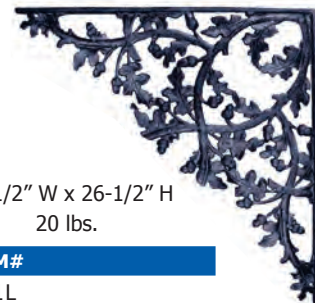

26-1/2" W x 26-1/2" H
20 lbs.

ITEM#
CI21L

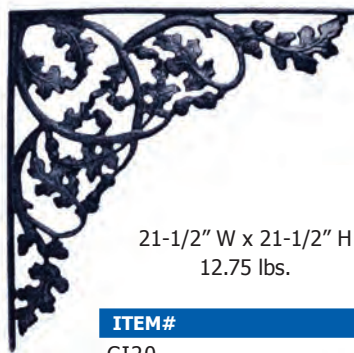

21-1/2" W x 21-1/2" H
12.75 lbs.

ITEM#
CI20

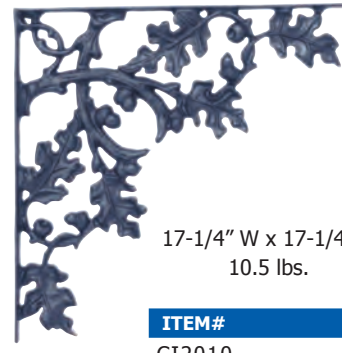

17-1/4" W x 17-1/4" H
10.5 lbs.

ITEM#
CI2010

California Oak

8" W x 18" H
5.25 lbs.



ITEM#

CI821

15" W x 15" H
5.5 lbs.

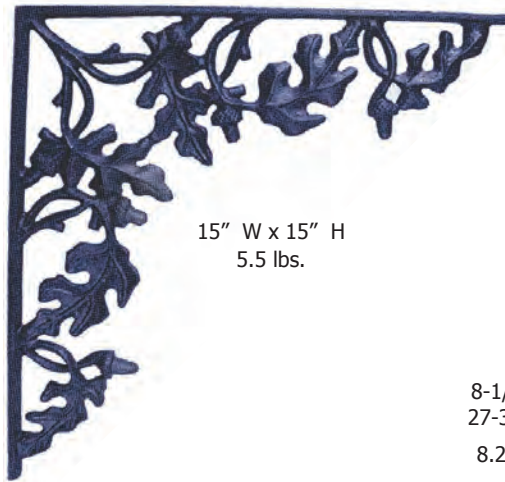

ITEM#

CI820

8-1/4" W
27-3/4" H
8.25 lbs.



ITEM#

CI823

Live Oak



Two casting
illustration

12" W x 27-1/4" H
18 lbs.

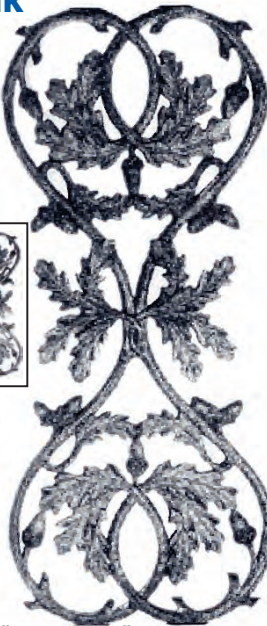

ITEM#

CIL424

Live Oak

12-3/4" W x 16-3/4" H
10 lbs.



ITEM#

CIL411

Continuous Design



8-1/4" W x 20-1/2" H
5 lbs.

ITEM#

CIL423

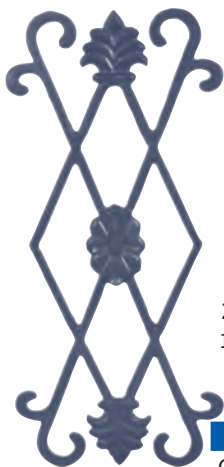

23-3/8" H
10-1/2" W
8.5 lbs

ITEM#
CI5015



23-1/2" H
7-1/2" W
9.5 lbs

ITEM#
CI5060



9" W x 27" H
11.5 lbs

ITEM#
CI5030



Single Faced
6-3/4" W x 32" H
4 lbs

ITEM#
CI5010



Single Faced
31-1/2" W
9" H
6 lbs.

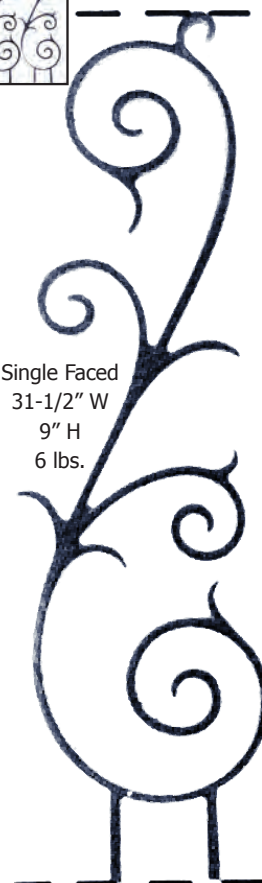

ITEM#
CI696

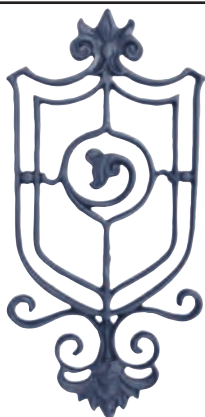

11-1/2" W x 23-3/4" H
9.75 lbs

ITEM#
CI5025



9" W x 23-1/2" H
12 lbs

ITEM#
CI5035

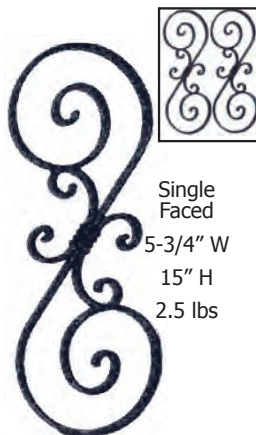

Single Faced
5-3/4" W
15" H
2.5 lbs

ITEM#
CI8507

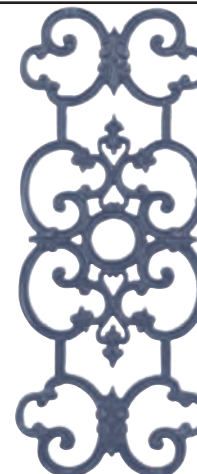

10-1/4" W
26" H
10 lbs.

ITEM#
CI5065



Two casting illustration

27-5/8" H
15-1/2" W
20 lbs.



ITEM#

CI648

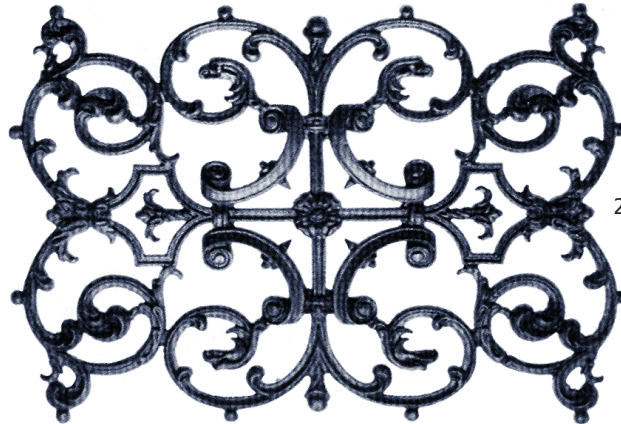

Single Faced
21-3/4" H x 30-5/8" W
30 lbs.

ITEM#

CI6317



11-1/4" W x 28-1/2" H
12.6 lbs.
Single Faced

ITEM#

CI5020



11-3/4" W x 27-3/4" H
20 lbs.

ITEM#

CI675XL

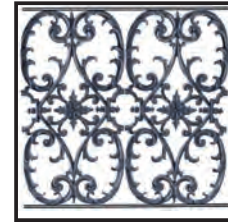

Two casting illustration



26-1/2" H x 13-3/4" W
17 lbs.

ITEM#

CI690



Single Faced
19-1/2" W x 29" H
27 lbs.

ITEM#

CI5055

Wedding Ring Design



19-1/4" H x
7-1/4" W
4 lbs.

ITEM#
CI150

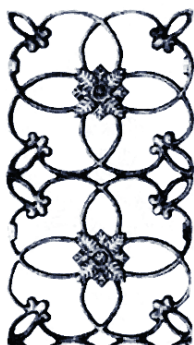

Close up of
Wedding Ring
Design

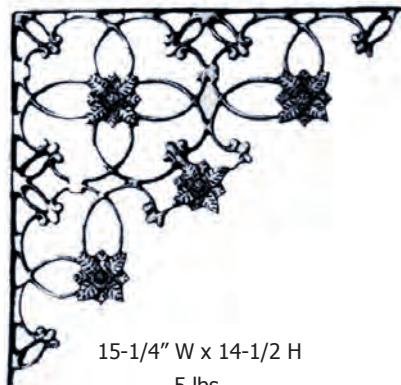

15-1/4" W x 14-1/2" H
5 lbs.

ITEM#
CI150B



33" H x 9" W
7.75 lbs.

ITEM#
CI9629



28-1/2" H x 9-1/2" W
7.25 lbs.

ITEM#
CI6357

Modern



10-3/4" W x 10-3/4" H
3.75 lbs

ITEM#
CI38SQ



9-3/4" W x 24-1/4" H
9.75 lbs

ITEM#
CI38XL



8-1/4" W x 16" H
4 lbs

ITEM#
CI94



10-3/4" W x 18-1/2" H
5.25 lbs

ITEM#
CI38X



30-3/4" H x 8-1/4" W
7 lbs.

ITEM#

CI88

Forms continuous pattern.
Turn page upside down for different view.



Two casting
illustration

17" W x 24" H
17.5 lbs

ITEM#

CI691



14" W
29-3/4" H (tip to tip)
28-1/2" (top bar to bottom bar)
12 lbs



Two casting
illustration

ITEM#

CI8504

Wheel Center Accents Muted with Flowing Tulip and Bud Designs



Radial flange on top is 36" end to end x 1" W x 3/8" thick.
Bottom flange is 34-1/2" W x 1/2" thick.
Vertical height through center of wheel is 12-3/4".
Overall: 12-3/4" H x 34-1/2" W
22 lbs.

ITEM#

CI9414



Radial flange on top is 24-1/2" end to end x 1" W x 1/2" thick
Bottom flange is 24-1/2" W x 3/8" thick. Vertical height through center of wheel is 12 1/4".
Overall: 12-1/4" H x 24-1/2" W
17.5 lbs.

ITEM#

CI9314

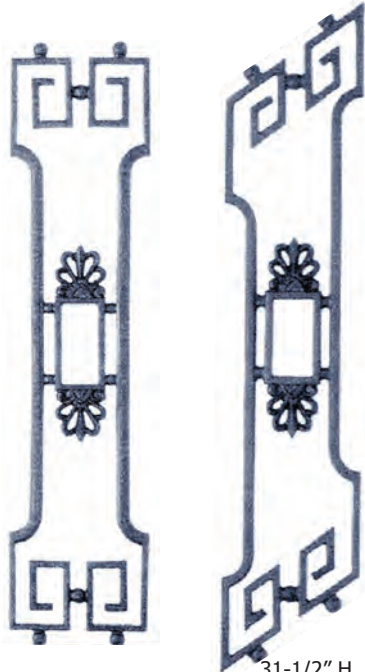

29" H x 6-3/4" W
9 lbs.

ITEM#
CI7462

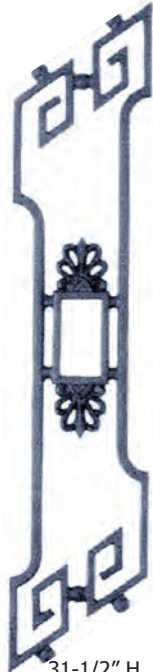

31-1/2" H
6-3/4" W
Pitch 35°
9 lbs.

ITEM#
CI7463

5-5/8" W
32-5/8" H
12 lbs.

ITEM#
CI9450



6-1/4" W x 30" H
12 lbs.

ITEM#
CI646



6" W
27-3/4" H
9.5 lbs.

ITEM#
CI189



11-1/8" W
26" H
10 lbs.

ITEM#
CI623



11" W
34-1/4" H
12 lbs.

ITEM#
CI306

CAST IRON BALLS Many uses - stack vertically or horizontally



2" dia
Flat on bottom to receive
1" square 3/4" deep hole
doesn't go through
1 lbs

ITEM#
CI9328



2-1/2" dia
3/4" square hole
completely through
1.75 lbs

ITEM#
CI673CF

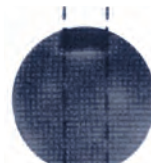

2-1/2" dia
1" square hole
completely through
1.5 lbs

ITEM#
CI673X1

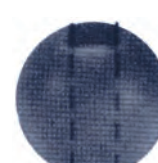

3-1/4" dia
1" square hole
completely through
2.0 lbs

ITEM#
CI674CF

Cherub Gate Crown



33-3/8" W x 10-1/4" H
16 lbs.

ITEM#
CI9988



14-1/2" W x 26" H
18 lbs.

ITEM#
CI8658

Decorative Metal Casting



32-5/8" W X 25-1/2" H
60 lbs.

ITEM#
CI8657

Square Scroll Panel

24-3/4" W
22-1/2" H
17 lbs.



ITEM#

CI8656

Grill Grate or Vent

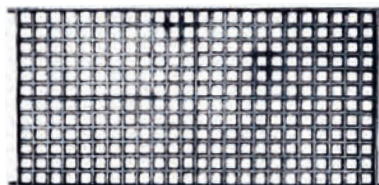

24" W x 12" H 3/4" Sq. Grid
11 lbs

ITEM#

CI705G

Recess Vent



17-1/2" W x 9-1/2" x H x 2" D
16 lbs.
7/8" x 1-1/2" Grid Size

ITEM#

CI699



Single Faced
23" x 23"
14 lbs.

ITEM#

CI7618

Florentine Circle



Single Faced
22-1/4" dia
27 lbs.

ITEM#

CI617

Center Piece, Wall Art, Grille



Single Faced
10-3/4" W x 14-5/8" H
8.5 lbs.

ITEM#

CI726

Vineyard Emblem For Fence, Railing, etc.



Single Faced
20" diameter
20 lbs.

ITEM#

CI14XL

Good Luck Circle



10-1/2" dia 1" Thick
9 lbs.

ITEM#

CI8325

Hand Carved Flowers & Basket Design



28-1/2" H x 16-3/4" W
20 lbs.

ITEM#

CI864X

Single Faced
22" H x 11-1/2" W
9lbs.



ITEM#
CI9360

Single Faced
Backed Out
27-1/4" H x 11-1/4" W
11.5 lbs.



ITEM#
CI686

26-3/4" H
12-1/2" W
19 lbs.



ITEM#
CI9634

Single Faced
Backed Out
28-3/4" H
11-3/4" W
14 lbs.



ITEM#
CI9611

Single Faced
18" H x 7-1/2" W
5.5 lbs.



ITEM#
CI9345

Single Faced
15" H x 8-5/8" W
3.75 lbs



ITEM#
CI9347



28-1/8" W x 11" H
34.25 lbs.

ITEM#
CI9935



39-1/2" W x 24-3/4" H
82.5 lbs.

ITEM#
CI8660F

Crown

13" H x 37" W
13.5 lbs.



ITEM#

CI7215

Scalloped Cresting

12" H x 31-1/4" W
9.8 lbs.



ITEM#

CI5095

Gate/Rail Top or Wall Decor

12-1/2" x H 31" W
15.5 lbs.



ITEM#

CI3010

Elegant Crown Design

32-1/4" W x 10-1/4" H
13.75 lbs.



ITEM#

CI7217



6-3/4" W
9-3/4" H

ITEM#

CI358

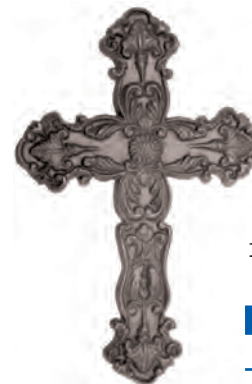

6-3/4" W
10-1/4" H
1.75 lbs

ITEM#

CI356



9-5/8" W
12-1/4" H
3.8 lbs

ITEM#

CI357



9-3/8" W
14-1/4" H

ITEM#

CI355

Crown Design



10" H x 22" W
7 lbs.

ITEM#
CI680

Decorative Pieces



Single Faced
13-7/8" W x 7" H
3 lbs

ITEM#
CI9350



Single Faced
8" W x 4" H
1.3 lbs

ITEM#
CI9351L



Single Faced
8" W x 4" H
1.3 lbs

ITEM#
CI9351R

Door Castings



4-1/8" H x 31-5/8" W
6.25 lbs

ITEM#
CI5090



4-1/8" H x 25-5/8" W
4.75 lbs

ITEM#
CI5085



4" H x 21-1/2" W
3 lbs.

ITEM#
CI3540

Friezes, Valances, Filigree



5" H x 31-1/2" W
7.5 lbs.

ITEM#
CI1348



5" H x 33-1/4" W
9.25 lbs.

ITEM#
CI1345



4" H x 28-3/4" W
5.5 lbs.

ITEM#
CI5005

Posts - Raphael

In two pieces for "fabricator ease"

Top in one piece
24 1/2"

1 3/4" Ø ID

Bottom in one piece
23 1/2"



5" Octagonal Base
47" H x 5" W 51.5 lbs.

ITEM#
CI9115X

Philadelphian

These do not Bolt. Should be Tack Welded

Four pieces

Top in two pieces
27"

2 3/4" Ø ID

Bottom in two pieces
24 1/2"

2 3/4" Ø ID



4" Sq. Base
51-1/2" H x 4" W 77 lbs.

ITEM#
CI9116

Victorian

Two pieces

Top in one piece
28"

28"

2 7/8" Ø ID

Bottom in one piece
19"

2 7/8" Ø ID



4-1/2" Sq. Base
47" H 65 lbs.

ITEM#
CI9113X

Crown

12"

3-1/2" W x 12" H
1-1/4" Hole is 8" Deep inside crown

4.25 lbs.

This Crown Fits Below Post Item # CI8192

ITEM#
CI8191

30 1/4"

Each item is cast and sold in halves with 7/8" hole through center when matched

Roman Post

3-1/2" W x 30-1/4" H
1-1/4" Hole is 7" Deep inside bottom of post

Roman Post 14 lbs.

ITEM#
CI8192

This Post Fits Above Crown Item # CI8191

Pineapple Post & Top

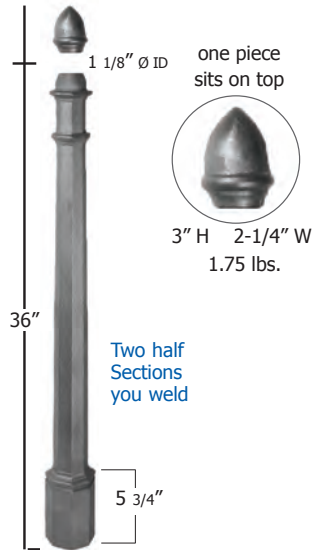

1 1/8" Ø ID

one piece sits on top



3" H 2-1/4" W
1.75 lbs.

36"

Two half sections you weld

5 3/4"

39" H x 4" W 20 lbs.
1-1/8" Ø ID

ITEM#
CI8194

Decorative Collars & Bases

Base



Fits over 3" round
One piece-8 sided
8-1/2" H x 6"W
17 lbs.

ITEM#
CI8397

Base



5-1/2" sq base
3-1/2" ID
3-1/2" deep
6 lbs.

ITEM#
CI9103

Collar For 4" Standard Pipe

Cast in halves to fit around new or existing



1-1/8" W x 8" H
4-3/4" Ø ID
10.25 lbs.

ITEM#
CI9102

Sold in pairs.
Two half sections that you weld together.

Column Base

Fits 4" sq.



5-3/8" H
6-1/8" sq OD
at bottom
10 lbs.

ITEM#
CI8398

Sold in pairs.
Two half sections that you weld together.

These do not Bolt. Should be Tack Welded

7" H x 3 1/8" W
3.5 lbs.

ITEM#
CI998P

4"
3"
27"
2 1/2" Ø ID
6" Base Dia.

27" H x 6" W
30 lbs.

Cast in one piece

ITEM#
CI999P

6" Base Dia.

2 3/8" Ø ID

29 3/4"

5-1/2" Base Dia.

Comes as one piece

29-3/4" H x 5-1/2" W
22.5 lbs.

ITEM#
CI7000X

2 1/2" Ø ID

26"

7" Base Dia.

Comes in two half sections

26" H x 7" W
39.5 lbs.

ITEM#
CI6003

Entire item will fit over 4" pipe

6 1/2"

9" W x 6-1/2" H
17.75 lbs.

ITEM#
CI6009

4 1/2" Ø ID

This Crown Fits Below Post Item # CI6009

26-3/4" H
10-1/2" W
83.5 lbs.

ITEM#
CI6008

10 1/2" Base Dia.

This Post Fits Above Crown Item # CI6008

26 3/4"

Comes in 2 half sections

Railing Designs

4-1/2" W x 36" H
5/8" sq. ends
4 lbs.

ITEM#
CI9640

4-1/2" W x 29" H
5/8" sq. ends
4 lbs.

ITEM#
CI9640D

28-3/4" H
Width at center 4"
2" Dia. top and bottom
14.5 lbs.

ITEM#
CI9681

35-3/8" H
7/8" dia. T
1-1/2" sq. b
12.5 lbs.

ITEM#
CI8304

Length 26"
Width at top and bottom 7-1/2"
6 lbs.

ITEM#
CI8306

Maxstar® 161 S 120-240 V Stick Welder



- » Separate 120 & 240 V allows for common power receptacles without use of tools
- » Fan-On-Demand™ power source cooling system operates only when needed, reducing noise, energy us and contaminants pulled into machine
- » Thermal overload protection helps prevent machine damage if duty cycle is exceeded or airflow is blocked
- » Digital meter allows for more precise control

Amperage Range:
20 DC-160 DC

12 LBS



Complete with:

6.5 ft primary cords for 120 V / 240 V
Stick electrode holder w/13 FT cable
Work clamp w/ 10 ft. cable and 25 mm Dinse-style connector
Adjustable handle/shoulder strap

ITEM#	MILLER #
MI907709	907709

Diversion™ 180 TIG Welder



Remote Foot Control

Includes RFCS-RJ45 remote foot control and multi-voltage plug (MVP™)

MVP allows for connection to 120- or 240-volt receptacles without tools

- » AC/DC TIG (GTAW)
- » Multi-voltage plug 115v or 230v
- » Welds steel .025 - 3/16"
- » Welds aluminum .030 - 3/16"



Choose the plug that fits the receptacle and connect it to the power cord



Complete with:

Power cord w/multi plug 115V or 230V
12.5 FT TIG torch - weldcraft A-150
12 FT work cable with clamp
RFCS-RJ45 remote foot control
Flow gauge regulator and gas hose
50 Lbs

ITEM#	MILLER #
MI907627	907627



Stickmate® 160i Welder



Complete with:

- » 10 ft. (3 m) electrode cable with heavy-duty holder
- » 10 ft. (3 m) work cable with clamp
- » 6.5 ft. (2 m) power cord with MVP™ adapters for 120 V and 240 V



Up to 85 More AMPS when Compared to the Leading Competitive Machine

- » Hot Start™ technology for easy, quick and reliable arc starts
- » Preferred DC output for fewer arc outages, less sticking, less spatter and best arc control
- » Portability & light weight makes it easier to carry and store

Specifications (Subject to change without notice.)

Input Power	Welding Amp Range	Rated Output	Max. Mild Steel Thickness
120 V	20-80 A	65 A at 20% duty cycle	1/8 in. (3.2 mm)
240 V	20-160 A	160 A at 30% duty cycle	3/8 in. (9.5 mm)

ITEM#	HOBART #
HB160I	500570

Amps Input at Rated Output	Max. Open-Circuit Voltage
20.7	91 V
27.8	

Power Receptacle and Plug

50A/230V



- » Pin-type receptacle
- » Cord range 0 - 1.00; Male plug

ITEM #	DESCRIPTION
MI219515	Pin-Type Wall Receptacle

ITEM #	DESCRIPTION
MI219516	Pin Type Male Plug

Champion® 145 DC Stick Welder AC Generator



- » DC stick (SMAW)
- » AMP output 40-145
- » 4,500 Surge watt AC generator
- » Briggs and Stratton 10 HP gasoline engine
- » Includes running gear
- » 6.25 gallon gas tank
- » 235 lbs

ITEM#	HOBART #
HB145	500563

Electrode Holders



- » Handles rods through 1/4"
- » Hi-Tong design; suited for most jobs
- » Vulcanized fibre material with copper alloy jaws.

ITEM #	CAPACITY
WS316	250 Amps
WSHT3	350 Amps

Ground Clamps

2" Jaw Capacity



ITEM #	AMP CAPACITY
A. WSEG300	300A Std. Duty
B. WSEG500	500A Std. Duty
C. WS300	300A Heavy Duty
D. WSLPG200	200A Light Duty
E. WSEGM50G	300A Magnetic Clamp

Female Cable Connector

- » 45 Degrees



ITEM #
WSCT10FA

Male Cable Connector



ITEM #
WSLC10M

Replacement MIG Contact Tip

For Use With:

Miller Acculock MDX
MIGmatic
Spoolmate / Spoolmatic
ProFax M25-Style*
Bernard Guns



ITEM #	WIRE	GUN
MI087299	.023"/.025"	MIGmatic M15 & M25
MI087067	.030"	MIGmatic M15 & M25
MI087068	.035"	MIGmatic M15 & M25
MPM000069	.045"	MIGmatic M25

ACCULOCK™ MDX SERIES

MITM023	.023"	MDX 100 & MDX 250
MITM030	.030"	MDX 100 & MDX 250
MITM035	.035"	MDX 100 & MDX 250

ITEM #	WIRE	GUN
MI186419	.030"	Spoolmate 3035 & 100
MI186406	.035"	Spoolmate 3035 & 100
MI206187	.030"	Spoolmatic 30A
MI206189	.053"	Spoolmatic 30A
MIT035	.035	Bernard MIG Gun
MIT045	.045	Bernard MIG Gun

*Any Miller M25 Consumables are Compatible with the ProFax M-25 Style

Replacement MIG Nozzle



- » Works with:
Miller Acculock MDX, MIGmatic, Spoolmate, Spoolmatic, ProFax M25-Style Guns*

*Any Miller M25 Consumables are Compatible with the ProFax M-25 Style

ITEM #	SIZE	GUN
MI169715	1/2" w/ flush tip	M15
MI169724	1/2" w/ 1/8" recess	M25
MI169725	5/8" w/ 1/8" recess	M25
MI169726	5/8" w/ flush tip	M25
MI246372		M100, M150

ACCULOCK™ MDX SERIES

MINM1200C	1/2" w/flush tip	MDX M-250
-----------	------------------	-----------

Contact Tip Adapter



ITEM#	GUN
MI169716	M10, M15, M100, M150
MI169728	M25

Copper Welding Cable

- » Sold in 50' 100' & 500' coils
- » Neoprene jacketed

ITEM #	SIZE	CAPACITY
WS2C200	#2	200 Amp
WS10C250	#1	250 Amp
WS10C300	#1/0	300 Amp

Cable Lugs



B-Type Solder-On

- » Copper alloy
- » Flared end

ITEM #	CABLE SIZE	AMP	ID CABLE SOCKET	STUD HOLE
WSB62	6-2	150	.461"	17/32"
WSB120	1-2/0	225	.559"	17/32"

L-Type Hammer-On

- » Same conductivity as the cable they connect
- » Twice as heavy as most crimp-type connectors
- » No soldering, bolting, set screws or crimping tools needed; Simple as driving a nail to attach

ITEM #	CABLE SIZE	AMP	ID CABLE SOCKET	STUD HOLE
WSL22	1/0-2/0	450	33/64"	17/32"
WSL33	2-1	300	13/32"	33/64"

Cable Connectors



- » With Positive Lock-Tight Action
- » Handles Cable Size Up to 1/0

ITEM #
WSLC10



Welding Tip Cleaner

- » Tapered ends eliminate scratching
- » Smooth leader pilot prevents damage to the tip port
- » Stainless steel

ITEM #	DESCRIPTION
WSWYPO	Welding Tip Cleaner



Arc-Force Magnetic Ground Clamp

300 AMP capacity

- » Great for welding object without clampable edges

ITEM #	DESCRIPTION
WSEGM50G	300 AMPS



Flashback Arrestors

- » Fits any size B regulator
- » Each set includes two arrestors
- » Inside valve stops reverse flow of gases into torch

ITEM #	DESCRIPTION
VCSH7536	Regulator to Hose Set
VCSH7436	Hose to Torch Set

Twin Line Torch Hose



- » Includes pre-fitted ferrules and brass connectors

ITEM #	DESCRIPTION
WS25	1/4" x 25 ft.
WS50H	1/4" x 50 ft.
WS100	1/4" x 100 ft.

Weld Cleaning Tomahawks



- » Hickory handle
- » 3 configurations
- » Steel head material

ITEM #	DESCRIPTION
WSWH10	A. Chisel & Cross Chisel
WSWH20	B. Cone & Chisel
WSWH30	C. Cone & Cross Chisel

Cleaning Hammers

For Cleaning Welding Debris

- » All metal construction
- » Spring-type handle
- » Dual design with chisel on one side and point on other to get into tight spots

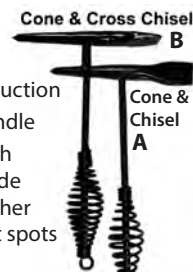

ITEM #	DESCRIPTION
WSS20	(A) Cone & Chisel
WSS30	(B) Cone & Cross Chisel

Cutting Torch Spark Lighters

- » Replaceable striking flint



ITEM #	PKG. QTY	DESCRIPTION
WS2001	1 each	Single Flint
WS4501	1 each	Triple Flint Style

RENEWAL FOR ABOVE LIGHTERS

WS2100X	5 pc.	Renewal Single Flint
WS5002X	4 pc.	Renewal Triple Flint

Silica Welding Blanket

6 FT. X 6 FT.

- » Heavy duty welding blanket
- » 18 oz. tan silica
- » Melting temperature of 3000° F
- » Grommets on all sides 36" apart



ITEM #	DESCRIPTION
WSBSL1866	Welding Blanket

Welding Blanket

5.7 FT. X 6 FT.
woven fiberglass

- » Washable and Lightweight
- » 1000°F continuous service temperature
- » Nylon bag with handles



ITEM #	DESCRIPTION
WS97455	Welding Blanket



Universal Circle Burner

Up to 30" Dia.

- » Cuts circles or straight lines with any oxyfuel cutting torch
- » Equipped with two wheels and centering pin

ITEM #	DESCRIPTION
WSCB30	Universal Circle Burner

Plastic Welding Rod Holder

- » Holds 10 lbs. of welding rods
- » Attached belt clip
- » Dimensions 15"x 3"



ITEM #	DESCRIPTION
WS674	Plastic Welding Rod Holder

Leather Welding Rod Holder

- » Heat resistant
- » Abrasion resistant
- » Sewn with Kevlar thread



ITEM #	DESCRIPTION
WS675	Leather Welding Rod Holder

Stainless Steel Welding Wire



- Wire Size: .030"
- ER 308L
- Shielding Gas Required
- Used for AISI types 304L, 308L, 321, 347

ITEM #	SPOOL SIZE
WW0302SS	2 lbs.
WW03010SS	11 lbs.

Aluminum Welding Wire



- Wire Size: .030"
- ER 4043
- Shielding Gas Required
- For 2014, 5052, 6061 and 6063 Sheets, Plates and Shapes

ITEM #	SPOOL SIZE
WW0301A	1 lb.

Anti-Spatter and Nozzle Dip

- » Prevents weld spatter adhesion to MIG gun nozzles, tips, electrode holders and welded products.



ITEM #	SIZE	TYPE
WSAS	16 oz. Aerosol	Anti-Spatter
WSNG	16 oz. Jar	Nozzle-Dip Gel

Specialty MIG Pliers

8 Specialty Tools in One

The Genuine MIG Tool

- » Specifically for CO₂ welding
- » Functionality includes; hammering, wire cutting, insulation bushing removal/installation & drawing out wire
- » Removes spatter from nozzle end

ITEM #
HT775

Flux Cored Welding Wire



- Wire Sizes: .030" / .035"
- 871T-GS
- No Shielding Gas Required
- For Mild Steel Welding

ITEM #	WIRE SIZE	SPOOL SIZE
WW030FC	.030	11 lbs.
WW035FC	.035	11 lbs.
WW0352FC	.035	2 lbs.
WW0302FC	.030	2 lbs.

Wire Lube Pads For All Welding Wire

6 Pieces per Package



- » Reduces burn-backs & erratic feed
- » Increases life of wire drive motor & wire feed surface
- » Safe & non-toxic pads remove dust contamination & lower friction
- » For MIG welding of steel, stainless hard-facing, silicon-bronze, aluminium, solid and flux core wire

ITEM #
WS7061

Standard Grade MIG Welding Wire



- Wire Sizes: .030" / .035"
- ER70S-6 Carbon Steel
- Shielding Gas Required
- For Mild Steel Applications
 - » AWS Specification: A5.18
 - » Welding Current: DCEP (Electrode Positive, Reverse Polarity)
 - » Yield Strength: 73,000 psi
 - » Tensile Strength: 90,000 psi
 - » Shielding Gas: CO₂

ITEM #	WIRE SIZE	SPOOL SIZE
WW023	.023	11 lbs.
WW03010	.030	11 lbs.
WW030	.030	30 lbs.
WW03510	.035	11 lbs.
WW035	.035	33 lbs.
WW045	.045	33 lbs.

Please Call for Quantity Pricing

Brazing Flux

- » Reduces clean up time
- » 1 LB container
- » Provides strong bond
- » Use for steel, brass, bronze, copper and malleable iron



ITEM#	SIZE
WSBF1	1 lb. Container

Low Fuming Brazing Rods



Sold Individually

ITEM #	SIZE / LENGTH
WRBR332	3/32" x 36"
WRBR18	1/8" x 36"

Flux Coated Brazing Rods



Sold Individually

ITEM #	SIZE / LENGTH
WRBRF332	3/32" x 36"
WRBRF18	1/8" x 36"



Hobart Mild Steel Welding Rods



6010 Electrodes

Deep Penetration

- » DCEP
- » Excellent vertical down
- » Smooth bead appearance

ITEM #	SIZE	GRADE	LBS PER BOX
WRSP6010332	3/32"	6010 DC	10 LBS
WRSP601018	1/8"	6010 DC	10 LBS
WRSP6010532	5/32"	6010 DC	10 LBS



6011 Electrodes

- » DCEP / AC **Deep Penetration**
- » Easy Arc Striking: Smooth bead

ITEM #	SIZE	GRADE	LBS PER BOX
WR6011332	3/32"	6011AC/DC	50 LBS
WRSP6011332	3/32"	6011AC/DC	10 LBS
WRSP56011332	3/32"	6011AC/DC	5 LBS
WR601118	1/8"	6011AC/DC	50 LBS
WRSP601118	1/8"	6011AC/DC	10 LBS
WRSP5601118	1/8"	6011AC/DC	5 LBS
WR6011532	5/32"	6011AC/DC	50 LBS
WRSP6011532	5/32"	6011AC/DC	10 LBS
WRSP56011532	5/32"	6011AC/DC	5 LBS



6013 Electrodes

Medium/Shallow Penetration

- » DCEP, DCEN / AC
- » Excellent arc stability
- » Perfect for poor fit-up material

ITEM #	SIZE	GRADE	LBS PER BOX
WR6013116	1/16"	6013AC/DC	50 LBS
WR6013332	3/32"	6013AC/DC	50 LBS
WRSP6013332	3/32"	6013AC/DC	10 LBS
WRSP56013332	3/32"	6013AC/DC	5 LBS
WR601318	1/8"	6013AC/DC	50 LBS
WRSP601318	1/8"	6013AC/DC	10 LBS
WRSP5601318	1/8"	6013AC/DC	5 LBS

Electrodes for Cast Iron Tack Welding

Great for Tack Welding Decorative Castings



- » Specifications: AWS/SFA AC-DC+
- » Non-machinable & non-nickel cast iron

ITEM #	SIZE
WRCAST	1/8"

7018 Electrodes

Medium Penetration

- » DCEP / AC
- » Smooth stable arc
- » Low spatter

Works Best with DC

ITEM #	SIZE	GRADE	LBS PER BOX
WR7018332	3/32"	7018 AC/DC	50 LBS
WRSP7018332	3/32"	7018 AC/DC	10 LBS
WRSP57018332	3/32"	7018 AC/DC	5 LBS
WR701818	1/8"	7018 AC/DC	50 LBS
WRSP701818	1/8"	7018 AC/DC	10 LBS
WRSP5701818	1/8"	7018 AC/DC	5 LBS
WR7018532	5/32"	7018 AC/DC	50 LBS
WRSP7018532	5/32"	7018 AC/DC	10 LBS
WRSP57018532	5/32"	7018 AC/DC	5 LBS

7014 Electrodes

Medium Penetration

- » DCEP, DCEN / AC
- » Increased deposition rate, faster travel
- » Slag detaches easily
- » Iron powder coating
- » Increased weld elasticity

ITEM #	SIZE	GRADE	LBS PER BOX
WR7014332	3/32"	7014AC/DC	50 LBS
WRSP7014332	3/32"	7014AC/DC	10 LBS
WR701418	1/8"	6013AC/DC	50 LBS
WRSP701418	1/8"	6013AC/DC	10 LBS
WRSP5701418	1/8"	6013AC/DC	5 LBS



Tungsten Welding Electrodes



Use with AC or DC

- Non-radioactive
- 2% Ceriated Tungsten
- 10 Pieces per Pack
- » Best for carbon & stainless steels, titanium and copper alloys, nickel & nickel alloys

ITEM #	SIZE	COLOR CODE
WRT332	3/32"	Orange
WRT18	1/8"	Orange

Aluminum Welding Rods - 1/8"

Sold by the Pound

- » All position rod
- » E 4043
- » Welds cast aluminum, wrought and extruded aluminum and aluminum alloys

ITEM #	SIZE
WR18AL	1/8"

Stainless Steel Welding Rods

- » AC-DC
- » AISI 308 AWS E308-16
- » Titania type coating
- » Moisture resistant electrodes
- » All positions; AC or DC reverse polarity



Available in 1 lb. & 5 lb. cans

ITEM #	SIZE
WR308332	3/32"
WR30818	1/8"

Ridgeline Ratchet Headgear



- » Constructed from durable nylon
- » Ratchet adjustment for easy fit
- » Pivoting action allows user to lift face shield while wearing
- » Adjustable pegs will accommodate a wide variety of face shields
- » **Body Thickness:** 2.05mm
- » **Weight:** 7.4oz
- » **Crown Depth:** 6.25"

ITEM #	DESCRIPTION
WSF3003N	Pyramex Headgear

Face Shield

- » Meets ANSI Z87+
- » Provides 99% UVA/B/C protection
- » Universal slots will accommodate a wide variety of headgear
- » **Thickness:** 0.040"
- » **Weight:** 2.5 oz
- » **Size:** 8" x 15"



Face Shield Shown with Ridgeline Ratchet Headgear Sold Separately

ITEM#	DESCRIPTION
WSFCLN	Clear Shield
WSFGRN	Green Shield

Fixed Shade Replacement Lenses



ITEM #	DESCRIPTION	SIZE
WS10L	Shade 10	2" x 4-1/4"
WS11L	Shade 11	2" x 4-1/4"
WS12L	Shade 12	2" x 4-1/4"
WS10L45	Shade 10	4-1/2" x 5-1/4"
WS11L45	Shade 11	4-1/2" x 5-1/4"
WS12L45	Shade 12	4-1/2" x 5-1/4"
WSCR39S	Clear	2" x 4-1/4"
WSCR39L	Clear	4-1/2" x 5-1/4"

Replacement Headgear



- » For Miller Performance Series and Pro-Hobby Series welding helmets

ITEM #	DESCRIPTION
MI770246	Miller Headgear

Knee Pads

- » Exclusive grooved cap design prevents thread abrasion
- » Super tough, light weight fabric covering
- » Comfortable, double straps with hook and loop fasteners, one size fits all



ITEM#	DESCRIPTION
HT150380	Knee Pads

Lens Covers

- » For the following Miller welding helmets: Classic, Classic VSi, Performance, Pro-Hobby
- » Size: 4-3/8" x 5"

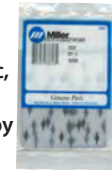

ITEM #	DESCRIPTION
MI231921	Performance Outside
MI770237	Performance Inside
MI231411	Classic or Pro-Hobby Outside
MI231410	Classic, Classic VSi, or Pro-Hobby Inside
MI235628	Classic VSi Inside
MI245818	Classic VSi Grinding Shield Lens Cover

Omni-Mag Welding Lens Magnifier

- » Fits standard 2" x 4-1/4"



ITEM #	DESCRIPTION
WS100M	1.00 diopter
WS150M	1.50 diopter
WS200M	2.00 diopter
WS225M	2.25 diopter



Creator™ Series Auto-Darkening

NEW!



PureColor™



PureColor™ Lens Technology Offers the Welder a Brighter View with Accurate Color and Improved Clarity

- » Sensitivity and Delay Controls for Any Welding Environment
- » Large Viewing Area - 7.1 Inches
- » PureColor™ Lens Technology
- » Three Independent Arc Sensors
- » Grind Mode Prevents Lens from darkening, keeping clear visibility
- » Analog Controls allows welder to adjust shade, sensitivity and delay
- » Two year warranty



Quick Specs

Viewing Field 3.82 x 1.85 in.
Shades:
Darkened state: #9-13
Light state: #3
Switching Speed: 1/25,000 second
Operating Modes: Weld and grind
Sensors: 3
Weight: 19oz.

ITEM#	DESCRIPTION
HB770866	Welding Helmet



Pillar™ Series Auto-Darkening

NEW!



PureColor™



- » Long-lasting battery provides up to 6,000 hours of welding protection
- » Expanded Viewing Area -6.2 Inches
- » PureColor™ Lens Technology
- » Two Independent Arc Sensors
- » 100% continuous UV and IR protection
- » Auto-on/off power control triggers lens at the stike of arc
- » Two year warranty

Quick Specs

Viewing Field 3.78 x 1.65 in.
Shades:
Darkened state: #10
Light state: #3
Switching Speed: 1/10,000 second
Operating Modes: Weld
Sensors: 2
Weight: 16.2oz.

ITEM#	DESCRIPTION
HB770860	Welding Helmet



Classic Series, FS #10, 2x4 Flip-Up



- » Integrated Grind Shield
- » Two independent Arc sensors
- » Auto-On/Auto-Off power control
- » 5 outside cover lenses
- » 2 inside cover lenses

ITEM#	DESCRIPTION
WS263038	Welding Helmet

Find the Latest in Welders on Page 208



Economy Welding Helmet



- » Passive lens; Shade 10
- » 2" x 4-1/4" flip-up front
- » Posilock sure-fitting welding helmet

ITEM#	DESCRIPTION
WS770257	Welding Helmet

Classic Series Auto-Darkening

- » Magnifying lens holder
- » Rechargeable solar cell
- » Features fixed shade #10 & light shade #3
- » **Two Arc Sensors:** 1/ 3,600 sec. lens speed
- » **TIG Rating:** 20 Amps
- » Meets ANSI Z87.1+ (2010) & CSA standards
- » 2 year warranty
- » Weighs only 6 oz.
- » 2-Lithium batteries



ITEM#	COLOR	ITEM#	COLOR	ITEM#	COLOR	ITEM#	COLOR
WS287369	Liberty	WS271346	Metalworks	WS271349	Rise	WS251292	Classic Black



Classic Series, VSi™



← Has an
Integrated
Grind
Shield

Now with ClearLight™ 2.0 Lens Technology

Advanced High-Definition Optics that Provide a Clearer, Brighter, and the Most Realistic View Before, During, and After Every Weld

- » Integrated Grind Shield
- » Three Operating Modes – Weld/Cut/Grind
- » Two independent arc sensors
- » Auto-On/Off power control
- » X-Mode
- » Durable Shock-Absorbing Gasket
- » 5 Outside Cover Lenses
- » 2 Inside Cover Lenses

ITEM#	DESCRIPTION
WS260938	Welding Helmet
MI235628	Outside Lens Cover
MI231410	Additional Inside Lens Cover
MI245818	Grinding Shield Lens Cover



Performance Series

Auto-Darkening

Now with ClearLight™ 2.0 Lens Technology

Advanced High-Definition Optics that Provide a Clearer, Brighter, and the Most Realistic View Before, During, and After Every Weld

- » 7.22 sq. inch viewing area
- » Three Arc Sensors for superior lens response
- » Three Operating Modes – Weld/Cut/Grind
- » Auto-On/Off power control triggers lens at the strike of an arc
- » Half Shade Settings for precise shade adjustments
- » Additional adjust ability settings for a better fit
- » Weighs only 17 oz.;
- » 2-Lithium batteries
- » Included: 5 outside cover lenses, 2 inside cover lenses, helmet bag
- » Three Year Warranty

ITEM#	DESCRIPTION
WS282005	Crusher
WS241458	Blue Rage™
WS250532	'64 Custom



Welding Curtain & Frame (Sold Separately)



Can be Used Around MIG, TIG, Arc, & Plasma Operations



FRAME

- » Constructed with 19-gauge steel tubing and bolted corner clamps for extra durability
- » Black powder-coated enamel finish is rust and abrasion resistant
- » Pre-drilled for casters if extra mobility is desired
- » Comes complete with brackets, hardware, and lacing ties

CURTAIN

- » Puts light back into the welding area to help increase worker productivity
- » Excellent for use in assembly areas
- » Flame, mildew, and water resistant
- » Durable PVC material resists tearing
- » Built with grommets for easy hanging
- » All curtains meet or exceed ANSI/FM 4960, California Fire Marshall standards, and NFPA 701 requirements for flame resistance
- » Finished size on standard orders may vary up to 3" in height and width

ITEM#	DESCRIPTION
WS97305	6' x 6' Curtain Only
WS97205	6' x 6' Curtain Frame

LPR-100™ Half Mask



Ideal for use with a welding helmet



Provides 99.9 Filtration of Airborne Particles & Oil-based / Non Oil-based Aerosols

Assigned Protection Factor (APF) 10
Certifications NIOSH 42 CFR 84

- » Made with Medical-Grade Materials; free of latex and silicone; odor-free and non-allergenic
- » Non-return exhaust valve reduces heat buildup
- » Stainless steel (hexavalent chromium), galvanized steel (zinc oxide), steel/manganese alloys, aluminum, cadmium and lead fume
- » Four-Point Head Strap

Replacement Filters Sold in Pairs



ITEM #	DESCRIPTION
WSML00895	Half Mask (Includes Filter Pair)
WSSA00818	Pair Replacement Filters

Disposable Dust and Particle Mask

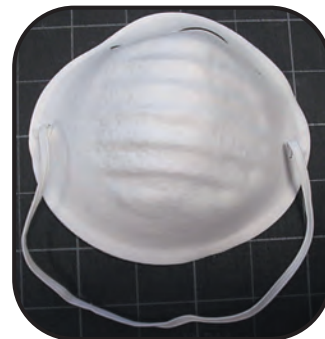

- » Complete with elastic strap
- » Sold individually or 50 piece boxes
- » Helps protect against non-toxic dusts and spray paint

ITEM#	DESCRIPTION
WS1501	Dusk Mask

Paint & Pesticide Respirator N95

- » Long-life pre-filters approved to the NIOSH P95 Class, and are at least 95% efficient against oil /non-oil based contaminants and are oil-proof so they have no time use limitation
- » Hygiene cover helps keep dirt out of mask when not in use and help keep shape of seal intact
- » Flexible face piece material provides excellent seal
- » Headband swivels on hinges for improved comfort

Respirator & long-life pre-filters are certified by NIOSH as an R95/OV respirator



Includes Pair of Respirator Cartridges



Replacement Cartridges Sold Separately

ITEM #	DESCRIPTION
WS152241	Standard Size Half Mask
WS152245	Replacement Cartridge (Pair)



Provoq Series



- » High Impact
- » Meets ANSI Z87 safety standards

ITEM#	DESCRIPTION
WSS7210	Clear Frame/ Clear UV Lens
WSS7260	Infinity Blue Frame/ Blue Lens

Ever-Lite Series



- » Anti-fog with UV filters; high impact
- » Meets ANSI Z87 safety standards

ITEM#	DESCRIPTION
WSSB861	Black Frame/ Clear Lens
WSSB862	Black Frame/ Gray Lens

Velar Series



- » High Impact
- » Meets ANSI Z87 safety standards

ITEM#	DESCRIPTION
WS10420D	Black Frame/ Gray UV Lens
WS10465D	Ice Blue Mirror Lens / Black Frame

Ztek Series



- » High impact; lightweight
- » One piece with rubber temple tips
- » Meets ANSI Z87 safety standards

ITEM#	DESCRIPTION
WSS2510	Clear Frame/Clear Lens/Anti-fog
WSS2565	Purple Frame/Purple Haze Lens
WSS2540	Orange Frame/Orange Lens

PMXTREME Readers Series



+2.5 Readers



- » +2.5 readers with UV filters
- » Meets ANSI Z87 safety standards

ITEM#	DESCRIPTION
WSSB631	Black Frame/ Clear Lens
WSSB631A	Black Frame/Clear Lens w/LED

Furix Series



- » Anti-fog; high impact
- » Meets ANSI Z87 safety standards

ITEM#	DESCRIPTION
WSSB851	Black Frame/ Clear Lens
WSSB852	Black Frame/ Gray Lens

MegaMIG™ Premium Goatskin Welding Gloves

- » Designed for ultra comfort and dexterity for MIG gun welding
- » Full cotton fleece lining
- » Seamless index finger
- » Wing thumb
- » Elastic gathered back; 4-1/2" cuff



ITEM #	SIZE
WS0215L	Large
WS0215X	X-Large

Premium Foam Lined Welding Gloves

- » Made from select side split leather
- » Flame Resistant
- » Palm Patent
- » Kevlar Thread



ITEM#	DESCRIPTION
WS2119B	Brown - Foam-Lined Welding Gloves
WS2519B	Blue - Foam-Lined Welding Gloves
WS2619B	Black - Foam-Lined Welding Gloves

Deerskin Welder's Gloves

- » Amazingly soft, comfortable and flexible, with excellent protection
- » Sewn with Kevlar® thread in a gunn cut pattern with a straight thumb
- » Fully welted and lined, has thumb strap and pull strap



ITEM#	DESCRIPTION
WS2275	Deerskin Welding Gloves

Pigskin Leather Welding Gloves

- » Reverse grain leather palm provides excellent sense of touch
- » Foam back, reinforced thumb strap and pull strap
- » Fully welted



ITEM#	SIZE
WSP750L	Large
WSP750LX	X-Large

Natural Thumb™ Welding Gloves with Heat Resistor Lining



- » Features triple layer insulation
- » Curved finger base and natural thumb virtually eliminate stress
- » Fully welted and 100% Kevlar® sewn
- » Garmet grade leather with integrated palm and thumb reinforcement

ITEM#	COLOR
WS21NT	Brown
WS25NT	Blue

Pearl Grey Split Grain Leather Welder With Lining

- » Welding Gloves fully stitched
- » Cotton lining for heat protection



ITEM#
WS2G

Grain Goatskin Leather Driver's



- » Premium grain goatskin
- » Reinforced wing thumb
- » Gunn cut
- » Para-aramid liner //TPR// HI-Vis
- » Hook + loop closure

ITEM#	SIZE
WS3004CWM	MEDIUM
WS3004CWL	LARGE
WS3004CWXL	X-LARGE

Glove Clip

- » Breakaway feature for safety



ITEM#
WSC120



Premium TIG Glove

- » Extra soft top-grain leather TIG glove with Kevlar® stitching.

ITEM#
WSTG



Driver's Gloves

- » Top grain leather driver's glove with keystone thumb. Size regular or extra large.

ITEM#
WS3TL



Plastic Dot Work Gloves

- » Cotton work glove with black plastic dots

ITEM#
WS5DG



Brown Jersey Cotton Glove

- » Clute cut, heavy weight Brown Jersey glove with knit wrist.

ITEM#
WS4J

Ultimate Gripper Work Gloves Pig Grain with PVC Reinforcements

- » Protective Neoprene® knuckle guard maintains contour fit
- » Finger and palm reinforcements, double layered in wear zones
- » Pre-curved finger design reduces fatigue and improves dexterity
- » Reinforced padded thumb saddle adds strength at stress point



ITEM#	SIZE
WS912L	Large
WS912X	X-Large



Leather Palm Work Gloves

- » Leather and canvas work gloves with safety cuff

ITEM#
WS1G



Disposable Latex Gloves

- » Lightly powdered
- » Each glove features textured fingers that are ideal for gripping dirty parts and tools
- » **50 gloves per box**

ITEM#
WS301551

Cut-Resistant Gloves

- » 13 gauge salt and pepper DSM Certified Dyneema shell
- » Gray PU coated palm and fingertips
- » CPPT Cut Level 2



ITEM#	DESCRIPTION
WS9672L	Size Large
WS9672XL	Size X-Large



Indura® Cloth Jacket



- » Indura® 100% Cotton
- » Derived from "industrial durability," made with 100% flame resistant fabric that is guaranteed for the life of the garment.
- » Jackets are already pre-shrunk, eliminating possibility of shrinkage and allowing for optimal fit.
- » Nomex®
- » Sewn with flame resistant Nomex® thread.
- » Extra Neck Protection
- » Barracuda style stand-up collar for extra neck protection.
- » Easily accessible slash front pockets.
- » Fold-in sleeve snaps that provide a better fit around the wrist.

ITEM#	DESCRIPTION
WS258098	Size Large
WS258099	Size X-Large
WS258100	Size 2X-Large

Classic FR Cotton Sleeves

- » 18 inch length
- » Innovative one-handed crinch closure for easy adjustability
- » "Fold-in" sleeve snaps for a better fit around the wrist



ITEM#	SIZE
WS247148	One size fits all

Classic FR Cotton Apron



- » 35 inch length
- » Convenient adjustable drawstring ensures a superior fit around the neck and waist
- » Accessible front pocket

ITEM#	SIZE
WS247149	One size fits all

Fire Retardant Aprons



- » Available in green and rust colors.
- » Made of fire Retardant Proban FR7
- » Sizes in stock: 42" L

Other sizes available upon request. Please specify when ordering.

ITEM#	DESCRIPTION
WSU200	Fire Retardant Apron

3-Piece Rainsuit



- » 32" Long Jacket
- » .35mm PVC/Polyester/PVC fabric

ITEM#	DESCRIPTION
HT750122	3-Piece Rainsuit

Leather Utility Apron



- » 36" length
- » Made of heat and abrasion resistant select leather, sewn with Kevlar® thread

ITEM#
WSUA

Non-Woven Coveralls



- » Zipper closure
- » Puncture & tear-resistant
- » One size fits most wearers

ITEM#	DESCRIPTION
HT152822	Coveralls

Flame Retardant Work Shirts

Meets OSHA 1910.269 and 1910.132

- » 7 oz. FR-treated cotton w/FR threads
- » Shatter-proof FR melamine buttons
- » Chest pockets w/ flaps & pencil slot
- » NFPA 2112; NFPA 70E, ATPV 8.7 cal/cm (PPE Cat 2)



ITEM#	DESCRIPTION
WSFRSDM	Denim Medium
WSFRSDL	Denim Large
WSFRSDXL	Denim XL
WSFRSDXXL	Denim XXL



ITEM#	DESCRIPTION
WSFRSGM	Gray Medium
WSFRSGL	Gray Large
WSFRSGXL	Gray XL
WSFRSGXXL	Gray XXL



ITEM#	DESCRIPTION
WSFRSKM	Khaki Medium
WSFRSKL	Khaki Large
WSFRSKXL	Khaki XL
WSFRSKXXL	Khaki XXL



Miller Classic Cloth Jacket

- » 9 oz. Flame-resistant navy cotton
- » Accessible inside pocket, "Fold-in" sleeve snaps for a better fit around the wrist.



ITEM #	SIZE
MICWJ	L & XL (please specify)

Cape Sleeve & 14" Bib

- » Made of heat and abrasion resistant select leather, sewn with Kevlar® thread
- » Sizes in stock: S - XL

(Other sizes available upon request. Please specify size when ordering)



ITEM#	DESCRIPTION
WSCS	Cape Sleeve
WSCSB	14" Bib

Lightweight Flame Retardant Cotton WeldMite® Jacket



- » Lighter than leather
- » Features an inside pocket
- » Made from 12 oz. permanently flame retardant, 100% cotton fabric

ITEM#	SIZE
WS10102	Large
WS10103	Extra-Large
WS10104	XX-Large

Leather Welder's Jacket

- » Made of heat and abrasion resistant select leather, sewn with Kevlar® thread
- » Features inner leather pocket
- » Sizes in stock: S - XL (Other sizes available upon request. Please specify size when ordering)



ITEM#	DESCRIPTION
WSLJ	Leather Jacket

Doo-Rags

- » Available in wide variety of colors!
- » 100% cotton
- » One size fits all



ITEM#
WSCRG

High Crown Fitted Welders Caps

- » Reversible caps in a variety of colors!



- » 100% cotton
- » Size: 6-1/8 - 8

ITEM#
WSCAP

Cutting / Notching / Grinding Wheels

- » For working on flat grinding surfaces
- » Aluminum oxide grain; Q-grade bond for fast cutting
- » Zirconia grain allows for faster cutting and longer life

ITEM#	SIZE	RPM
PABL412CH	4 1/2" x 1/8" x 5/8"-11	15,300

Type 27
24 grit

Excellent choice for metal, steel and general applications



Thin Reinforced Cut-Off Wheels

ITEM#	SIZE	RPM
PA45001	4" x .045" x 5/8"	15,300
PABD412C	4-1/2" x .045" x 7/8"	13,300
PA45005	5" x .045" x 7/8"	12,250
PA45008	7" x 1/16" x 7/8"	8,600

Type 27
60 grit



With Quick Change Metal Hub

ITEM#	SIZE	RPM
PABLCH7	7" x 1/16" x 7/8" Type 27	8,500

- » Zirconia and Aluminum Oxide grit mixture
- » Excellent on steel and stainless steel

Grinding Wheels

- » Available with and without quick change hub
- » Aluminum Oxide grain with special bond for fast cutting
- » Economical choice for metal and low grade stainless steel



Type 27
24 grit



With Standard Steel Reinforced Arbor Hole

ITEM#	SIZE	RPM
PABL4	4" x 1/4" x 5/8"	15,300
PABL412	4-1/2" x 1/4" x 7/8"	13,300
PABL5	5" x 1/4" x 7/8"	12,250
PAWS7NA	7" x 1/4" x 7/8"	8,600

With Quick Change Metal Hub

ITEM#	SIZE	RPM
PABD412H	4-1/2" x 1/4" x 5/8"-11	13,300
PAWS7T	7" x 1/8" x 5/8"-11	8,600
PABL7	7" x 1/4" x 5/8"-11	8,600
PAWS9	9" x 1/4" x 5/8"-11	6,600

14" Metal Cutting Diamond Edge Chop Saw Blade

- » Fits stationary chop saws
- » 100 times the life of a standard chop saw blade
- » Advanced Brazing Technology: Cuts metal with the speed of conventional abrasive blade
- » Exposed Diamond Matrix: Also cuts concrete, plastic, fiberglass, rubber, non-ferrous metals and other soft materials without loading

Type 1

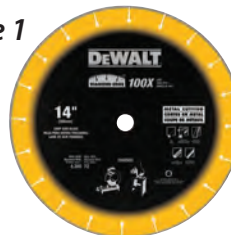

ITEM#	SIZE	RPM
PADW8500	14" x 3/32" x 1" arbor	4,300

7" Circular Saw Cut-Off Wheels

with Diamond-Shaped Arbor



Type 1, 24 grit

- » Aluminum Oxide for metal and steel



ITEM#	SIZE	RPM
PABL7C	7" x 3/32" x 5/8"-<	8,600

10" Stationary Saw Cut-Off Wheels

Type 1, 24 grit

- » Aluminum Oxide for metal and steel.
- » Used for cutting structural steel, bar stock, tubing and non-ferrous metals



ITEM#	SIZE	GRIT	RPM
PABL10	10" x 1/8" x 5/8"	24	6,110

Chop Saw Wheels

Type 1, 36 grit

- » Available in 12" and 14"
- » 1" round arbor
- » Aluminum Oxide for metals and Steel



ITEM#	SIZE	RPM
PABL12	12" x 3/32" x 1"	5,100
PABL14	14" x 7/64" x 1"	4,400

DeWalt Segmented Diamond Blades

- » For cured concrete and masonry
- » Diamond matrix provides 350 times the life of conventional abrasives



ITEM #	DIA.	EDGE	ARBOR
PADW4714	7"	.095"	5/8

3" Aluminium Oxide Roll-On Disc

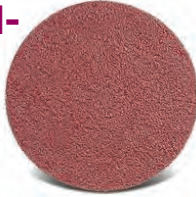

ITEM#	GRIT
PACG59543	120
PACG59537	36
PACG59540	60

3" Surface Conditioning Roll-On Disc



ITEM#	GRIT
PACG59506	Coarse
PACG59507	Medium
PACG59508	S Ultra Fine
PACG59509	Very Fine

3" Rubber Holder Pad



ITEM#	DESCRIPTION
PACG59734	Roll-On external thread

Sanding Disc Back Up Pads

Comes complete with lock nut. High quality flexible rubber. Fits 5/8"-11 spindle.



ITEM#	SIZE
PAWS412PAD	4-1/2"
PAWS7PAD	7"

Premium Flap Discs



- » Type 29
- » Standard 5/8" Hub
- » Premium Zirconia Alumina grit for aggressive removal
- » Fast grain removal for carbon-based steels and stainless steel

ITEM#	SIZE	GRIT	RPM
PAWS4AFD40	4"	40	15,300
PAWS4AFD60	4"	60	15,300
PAWS412AFD40	4-1/2"	40	13,300
PAWS412AFD60	4-1/2"	60	13,300
PAWS7AFD40	7"	40	8,600
PAWS7AFD60	7"	60	8,600

Sanding Sponges

Silicon Carbide, Closed Coat



- » Silicon carbide or aluminium oxide grain with a foam backing to provide conformability for hand finishing

ITEM#	SIZE	GRIT
PACG44822	3-7/8 X 4-3/4 X 1/2"	150
PACG44824	3-7/8 X 4-3/4 X 1/2"	220

Premium Flap Discs with 5/8"-11 Quick Change Metal Hub



- » Type 29
- » Premium Zirconia Alumina grit

ITEM#	SIZE	GRIT	RPM
PA412FD36	4-1/2" x 5/8"-11	36	13,300
PA412FD40	4-1/2" x 5/8"-11	40	13,300
PA412FD60	4-1/2" x 5/8"-11	60	13,300

EZ Strip Wheel



Non-woven wheels for cleaning welds and fast removal of rust, scaling, oxidation, paints, sealants and other clogging material. Type 27

ITEM#	SIZE	RPM
PA59204	4-1/2" X 7/8"	11,000

Sanding Blocks

Brown Aluminium Oxide, Closed Coat

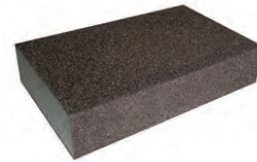

ITEM#	SIZE	GRIT
PACG44825	2-3/4 x 4 x 1"	100
PACG44826	2-3/4 x 4 x 1"	180

Resin Fiber Discs

ITEM#	SIZE	GRIT	RPM
PAWS4SD24	4" x 5/8"	24	15,300
PAWS4SD36	4" x 5/8"	36	15,300
PAWS4SD60	4" x 5/8"	60	15,300
PAWS412SD24	4-1/2" x 7/8"	24	13,300
PAWS412SD36	4-1/2" x 7/8"	36	13,300
PAWS412SD60	4-1/2" x 7/8"	60	13,300
PAWS7SD24	7" x 7/8"	24	8,600
PAWS7SD36	7" x 7/8"	36	8,600
PAWS7SD60	7" x 7/8"	60	8,600



- » Aluminium Oxide grit for long life and cool cutting
- » Backup pads not included.



Long Life Grinding Wheels with Spin-On 5/8"-11 Hub

- » A24R grit
- » Our most popular wheel
- » General purpose grinding
- » Longer life for fewer wheel changes



ITEM#	DIA	WIDTH	BORE	RPM
PAS20163	4-1/2"	1/4"	5/8"-11	13,300
PAS20173	5"	1/4"	5/8"-11	12,200
PAS20086	7"	1/4"	5/8"-11	8,500



Aluminum Grinding Wheels

- » 1/4" thickness
- » Soft bond for aggressive
- » removal of material without loading
- » Outlasts competition by as much as 40%
- » A46N grit



ITEM#	DIA	BORE	RPM
PAS20062	4-1/2"	7/8" Reinforced Hole	13,300
PAS20088	7"	5/8"-11 Threaded Hub	8,500



Grinding Wheels Concrete And Cast Iron or Masonry

- » 1/4" thickness
- » Soft bond for fast stock removal
- » C24N Silicon carbide grain
- » Can also be used on hard to grind metal like cast iron



ITEM#	DIA	BORE	RPM
PAS20061	4-1/2"	7/8" Reinforced Hole	13,300
PAS20087	7"	5/8"-11 Threaded Hub	8,500

General Purpose Super Thin Depressed Center Cutting Wheels

- » Hard bond for extremely long life
- » Fast, burr-free cutting



ITEM#	DIA	WIDTH	BORE	RPM
PAS22011	4"	.045"	5/8"	13,500
PAS22021	4-1/2"	.045"	7/8"	13,300
PAS22071	5"	.045"	7/8"	12,200
PAS22053	7"	.045"	7/8"	8,500

General Purpose Cutting Wheel for Circular Saws

- » Performance with long life
- » A24R grit



ITEM#	DIA	WIDTH	BORE	RPM
PAS23234	7"	3/32"	5/8"	8,500

Chopsaw Wheels

- » General purpose cool cutting on thin metals
- » Burr-free finish



ITEM#	DIA	WIDTH	BORE	RPM
PAS24039	14"	3/32"	1"	4,400
PAS24011	16"	3/32"	1"	3,700

Abrasive Flap Wheels

- » Aluminum Oxide abrasive for consistent cutting action
- » 1/4" shank



ITEM#	SIZE	GRIT	RPM
PA39908	1" x 1"	60	30,000
PA39909	1" x 1"	80	30,000
PA39932	2" x 1"	60	25,000
PA39933	2" x 1"	80	25,000
PA39948	3" x 1"	60	20,000
PA39949	3" x 1"	80	20,000

Grinding Cup Wheel

- » Type 11, grit 16
- » Aluminum Oxide for tough steel, ferrous metals applications. 5/8"-11 threaded arbor for quick change
- » 4" diameter face, 3" diameter base



ITEM#	SIZE	ARBOR	RPM
PAWS4CR	4"/3" x 2"	5/8"-11	9,070

Knotted Wire Cup Brush



- » Mini-Grinder Cup Brush
- » Two sizes: 2-3/4" or 4"

2-3/4" Face for 4" & 4-1/2" Grinders

ITEM#	ARBOR
WB58234K	5/8"-11

4" Face for larger 5" & 6" Grinders

WB58234K6	5/8"-11
-----------	---------

Crimped Wire Cup Brush



- » Mini Grinder Cup Brush
- » 2-3/4" face for 4" & 4-1/2" Grinders

ITEM#	ARBOR
WB58234C	5/8"-11

Cable Twisted Wire Wheel



ITEM#	SIZE	ARBOR
WB58114	4"	5/8"-11
WB58116	6"	5/8"-11

Bi-Metal Band Saw Blades

For Most Standard Size Portable Band Saws



ITEM #	LENGTH	WIDTH	TPI	THICKNESS
PAWSBSBM2	44-7/8"	1/2"	18	.020"
PAWSBSBR24	44-7/8"	1/2"	24	.020"

- » Such as Milwaukee, DeWalt and Porter Cable
- » Hard edge, bi-metal blade
- » 18 tooth & 24 tooth

For Milwaukee Compact Portable Band Saw

ITEM #	LENGTH	WIDTH	TPI	THICKNESS
PAWSBSB3518	35-3/8"	1/2"	18	.020"
PAWSBSB3524	35-3/8"	1/2"	24	.020"

- » Only for the Milwaukee Compact Portable Band Saw

Bearcat™ Bi-Metal BGT 12" Hacksaw Blades



- » High performance blades with ground teeth
- » Available in 18 or 24 tpi (specify)

ITEM #
WSHSB

Bi-Metal Cut Saw Blades



- » For reciprocating saws
- » 18 TPI

ITEM #	STYLE	SIZE
PABD41112	Short	4"
PABD41113	Long	6"
PABD41118	X-Long	8"

Heavy Duty Hacksaw Frame



ITEM #
HT100

6" Bench and Pedestal Wheels



- » Brown Aluminum Oxide for general purpose off-hand work
- » 1 inch hole with installed telescopic bushing for 3/4", 5/8" and 1/2" arbors

ITEM#	SIZE	RPM
PABD57624	6" x 3/4" x 1"	4,456



Heavy Duty Black Oxide Coated High Speed Steel Jobber Length Drill Bits

- » For general use in metal, wood and plastic
- » Black oxide coating resists corrosion
- » 135 degree split point ensures a true start and eliminates bit walking

INDIVIDUAL: Each Bit Card Packed

ITEM #	SIZE	LENGTH
PA67508 (2 pack)	1/8"	2-3/4"
PA67512	3/16"	3-1/2"
PA67516	1/4"	4"
PA67520	5/16"	4-1/2"
PA67524	3/8"	5"
PA67832	1/2"	6"
PA892740	9/16"	6"
PA892742	5/8"	6"
PA892744	11/16"	6"
PA892746	3/4"	6"
PA892748	13/16"	6"
PA892750	7/8"	6"
PA892752	15/16"	6"
PA892754	1"	6"
PA892756	1-1/8"	6"

Metal Drilling Step Drills

- » Single-fluted cutting edge assures true round holes
- » Ideal for drilling holes in thin materials such as mild steel, copper, brass, aluminum, plexiglass, and wood



ITEM#	DESCRIPTION
PA10231	1/8" - 1/2" (1/16" steps)
PA10232	3/16" - 1/2" (1/32" steps)
PA48899205	1/4" - 1-3/8"

Rotary Percussion - Straight Shank Hammer Drill Bits

- » Chrome vanadium shaft through-hardened to 50-53HRC
- » All tips made to ANSI specifications



ITEM #	SIZE	LENGTH
PA326005	1/4"	4"
PA326006	1/4"	6"
PA326008	5/16"	4-3/4"
PA326010	5/16"	12"
PA326011	3/8"	6"
PA326012	3/8"	12"
PA326014	7/16"	6"
PA326015	1/2"	6"
PA326016	1/2"	12"
PA326020	5/8"	*12"

*(1/2" Shank)

SDS-Plus Standard Tip Drill Bits

- » Chrome vanadium shaft through-hardened to 50-53HRC
- » All tips made to ANSI specifications

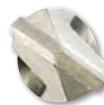

ITEM #	SIZE	LENGTH
PA322013	7/32"	6"
PA322016	1/4"	4"
PA322017	1/4"	6"
PA322019	1/4"	10"
PA322022	5/16"	6"
PA322023	5/16"	12"
PA322024	3/8"	6"
PA322026	3/8"	12"
PA322032	1/2"	10"
PA322033	1/2"	12"
PA322042	5/8"	8"
PA322043	5/8"	12"
PA322047	3/4"	8"
PA322048	3/4"	12"
PA322054	1"	10"



18 Piece Black Oxide Drill Bit Set

- » 1/16" - 1/2" with 3/8" reduced shank
- » 135° split point prevents walking
- » Black oxide coating resists corrosion

ITEM #	DESCRIPTION
PA314018	18 Pc Drill Bit Set



20 Pc. Drill/Driver Set

- » With black oxide HSS drills and screw-driver bits
- » 1/16" (2), 3/32", 1/8" (2), 5/32", 3/16", 1/4" drills and 12 screw- and nutdriver bits
- » 135° Split point tips prevents walking

ITEM #	DESCRIPTION
PA357020	20 Pc. Drill/Driver Set

Stanley® Fatmax® 1/4", 3/8" & 1/2" Drive 229 Piece

STANLEY
Matte Black
Chrome
Mechanic's
Tool Set



- » Oversized laser etched markings provide improved visibility
- » Matte black chrome finish delivers premium rust resistance
- » Chrome vanadium steel forgin
- » Durable blow mold carry case
- » Meet or exceeds ANSI specifications

Contents 1/4" Drive 6 Point Deep: 5/32, 3/16, 1/4, 5/16, 11/32, 3/8, 7/16, 1/2". 6, 7, 8, 9, 10, 11, 12, 13MM; 1/4" Drive 6 Point Standard: 5/32, 3/16, 7/32, 1/4, 9/32, 5/16, 11/32, 3/8, 7/16, 1/2, 9/16", 4,4,5,5,5,5,6,7,8,9,10,11,12,13,14Contents3/8 Drive 6 Point Standard: 5/16, 11/32, 3/8, 7/16, 1/2, 9/16, 5/8, 11/16, 3/4, 13/16, 7/8, 15/16; 8, 9, 10, 11, 12, 13, 14, 15, 16, 17, 18, 19mm; 3/8" Drive 6 Point Deep: 3/8, 7/16, 1/2, 9/16, 5/8, 11/16, 3/4, 13/16, 7/8", 10,11,12,13,14,15,16,17,18,19Contents1/2" Drive 12 Point Standard: 3/8, 7/16, 1/2, 9/16, 5/8, 11/16, 3/4, 13/16, 7/8, 15/16, 1", 10,11,12,13,14,15,17,18,19,21,22MM; 3/8 Drive 6 Point 5/8 & 13/16 Spark Plug Sockets; 1/4" & 3/8 Drive Universal Joint; 3/8 Drive Female to 1/4" Drive Male AdContents3/8" Drive E Sockets: E10,E11,E12,E14,E16; 3/8" Drv Bit Skts: T10,T15,T20,T27,T30,T40,T45,T50,T55 Hex 5/32,3/16,7/32,1/4,9/32",7,8,9,10mm; 1/4" & 3/8 & 1/2" Drive Pear Head Ratchet; 1/2" Drive 5" Extension BarContents1/4" Drive Multi-Bit Ratcheting Screwdriver; 1/4" Drive Nut Bits: 5/32, 3/16, 7/32, 1/4, 9/32, 5/16, 11/32, 3/8, 7/16, 1/2", 4,5,5,5,6,7,8,9,10,11,12MM; 1/2" Drive Female to 3/8" Drive Male AdapterContentsShort Hex Keys: 3/64, 1/16, 5/64, 3/32, 7/64, 9/64. 1.5, 2, 2.5, 3, 4, 4.5MM; Long Hex Keys: 7/64, 1/8, 9/64, 5/32, 3/16, 7/32, 1/4, 5/16. 1.5, 2, 2.5, 3, 4, 5, 6, 7MMContents(40) 3/8" Drive Bits; Bit Rails; PH1, PH2, PH3, S1, S2, S3 T20, T25, T27, T30; 5, 6mm 7/32, 1/4, T6, T7, T8, T9, T10, T15; 5/32, 3/16, 7/32, 2.5, 3, 4, 3/32, 1/8, 5/32, 3/16; 5, 6, 8, 10mm PD1, PD2, PD3, FD4, FD5, FD6

ITEM#	DESCRIPTION
HT71665	229 PC Stanley Tool Set



184 Piece Mechanic's Tool Set



- » CORROSION-RESISTANT finish with black chrome design
- » ABLE TO MOVE IN TIGHT SPACES: Includes 72-tooth count ratchets with a 5-degree arc swing to easily function in restricted areas
- » ANTI-SLIP GRIP: Bi-material grip bit driver for great grip and comfort
- » DURABLE CASE: Tools are housed in durable case with metal latches
- » Full Lifetime Warranty

INCLUDES:

- » Ratchets (3): 1/4, 3/8 in. and 1/2 in. Drive Pear Head Ratchet
- » 1/4 in. Drive 6 Point Sockets (24): (SAE) – 5/32 in. , 3/16 in. , 7/32 in. , 1/4 in. , 9/32 in. , 5/16 in. , 11/32 in. , 3/8 in. , 7/16 in. , 1/2 in. , 9/16 in. (MM) – 4mm, 4.5 mm, 5mm, 5.5mm, 6mm, 7mm, 8mm, 9mm, 10mm, 11mm, 12mm, 13mm, 14mm
- » 1/4 in. Drive 6 Point Deep Sockets: (SAE) – 3/16 in. , 7/32 in. , 1/4 in. , 9/32 in. , 5/16" (MM) – 7mm, 8mm, 9mm, 10mm, 11mm"
- » 3/8 in. Drive 6 Point Sockets (23): (SAE) – 1/4 in. , 5/16 in. , 3/8 in. , 7/16 in. , 1/2 in. , 9/16 in. , 5/8 in 11/16 in. , 3/4 in. , 13/16 in. (MM) – 6mm, 7mm, 8mm, 9mm, 10mm, 11mm, 12mm,13mm, 14mm, 15mm, 16mm, 17mm, 18mm
- » 3/8 in. Drive 6 Point Deep Sockets (14): (SAE) – 1/4 in. , 5/16 in. , 3/8 in. , 7/16 in. , 1/2 in. , 9/16 in. , 5/8 in. , 11/16 in. , 3/4 in. , 13/16 in. (MM) – 6mm, 7mm, 8mm, 9mm, 10mm, 11mm, 12mm,13mm, 14mm, 15mm, 16mm, 17mm, 18mm
- » 1/2 in. Drive 6 Point Sockets: (SAE) – 7/16 in. , 1/2 in. , 9/16 in. , 5/8 in. , 11/16 in. , 3/4 in. (MM) – 13mm, 14mm, 15mm, 16mm, 17mm, 18mm, 19mm
- » Combination wrenches (11): (SAE) 3/8 in. , 7/16 in. , 1/2 in. , 9/16 in. , 5/8 in. (MM) – 11mm, 12mm,13mm, 14mm, 15mm, 17mm
- » Accessories (6): 1/4 in. Drive 3 in. Extension Bar 3/8 in. Drive 3 in. Extension Bar 3/8 in. Drive 6 in. Extension Bar 3/8 in. Drive 5/8" Spark Plug Socket Spinner Handle Adapter"
- » Nut Bits (12): SAE – 3/16 in. , 1/4 in. , 9/32 in. , 5/16 in. 11/32 in. , 3/8 in. , 7/16 in. MM – 5, 6, 8, 10, 11"
- » Specialty Bits/ Hex Keys); 28 Hex Keys, 40 Specialty Bits

ITEM#	DESCRIPTION
BDDWMT181	184-piece DeWalt Tool Set

The Original™ Locking C-Clamps with Regular Tips



ITEM #	SIZE	JAW CAP.
WS6R	6"	2-1/8"
WS11R	11"	3-3/8"
WS18R	18"	8"

IRWIN VISE-GRIP®



The Original™ Long Nose Locking Pliers

ITEM #	SIZE	JAW CAP.
WS6LN	6"	2"

IRWIN VISE-GRIP®



The Original™ Curved Jaw Locking Pliers

ITEM #	SIZE	JAW CAP.
WS7CR	7"	1-5/8"
WS10CR	10"	1-7/8"



The Original™ Locking Welding Clamp

ITEM #	SIZE	THROAT DEPTH	JAW CAP.	JAW WIDTH
WS9R	8"	1-3/4"	1-5/8"	1-3/4"



The Original™ Locking Sheet Metal Tools

ITEM #	SIZE	THROAT DEPTH	JAW CAP.	JAW WIDTH
WS8R	8"	1-3/4"	1/2"	3-1/8"



The Original™ Large Jaw Locking Pliers

ITEM #	SIZE	JAW CAP.
WS12LC	12"	3-1/8"

JointMaster™ Angle Joining Tools

Quickly, easily set-up T-joints and corners

PL Series

Right Angle JointMaster™ is a fast, precise and affordable single-hand corner joining tool. "L" Handle quickly adjusts and tightens pivoting head to clamp workpieces.

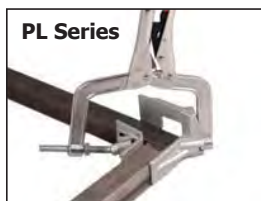

PA Series

Position the Adjustable JointMaster™ fixture from 30°-275°. Simply adjust to the desired angle, and "lock" into position using the handle. Join round, or flat workpieces, or materials with different thicknesses.



ITEM #	THROAT	CAPACITY	LENGTH	SERIES	SUPPLIED PLIERS
HTPL634	3"	1-1/4"	8"	PL	3" Throat, 4" Opening
HTPA634	3"	1-1/4"	8"	PA	3" Throat, 4" Opening



Aviation Snips

Blades are made of drop forged chromium steel and are precision ground for superior cutting quality. Straight cutting compound leverage snip.



Cuts left and straight

ITEM#
HT152506



Cuts right and straight

ITEM#
HT152507



Cuts left, right & straight

ITEM#
WSM3R



90° Aluminum Angle Clamp

- » 4" Throat Depth
- » 2-1/4" Jaw Length
- » 1-3/8" Jaw Height
- » Capacity Miter: 2-3/4"

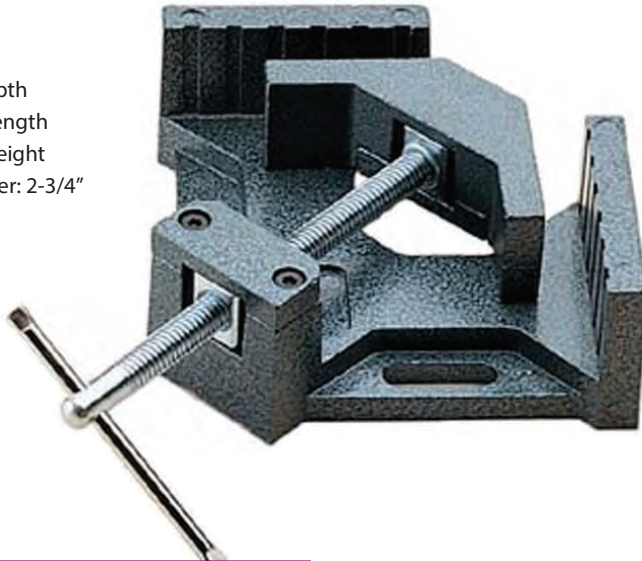

ITEM#	DESCRIPTION
HTWAC324	90° Alum. Clamp

MagTab™ Weld Tab Positioner

- » Hold small metal pieces, parallel or perpendicular to the substructure



Adjustable,
Magnetic
V-Shape Base



Adjusts for Different Work Piece
Shapes & Thicknesses

ITEM#	DIMENSIONS	WEIGHT
HTMFT10	4" x 3" x 1-1/4"	0.5 lbs.



4-in-1 Utility Clamp

- » 4-3/4" throat depth
- » Adapts to a pipe clamp, spreader clamp, and step-over clamp



ITEM #	CAPACITY	CLAMP
HTUF65C3	6-1/2"	1000 lbs.
HTUG125C3	12-1/2"	1200 lbs.



Quick Grip "C" Clamps

- » Larger swivel pads reduces marring on work surface



ITEM #	SIZE	ITEM #	SIZE
HT225102	2" C-Clamp	HT225106	6" C-Clamp
HT225103	3" C-Clamp	HT225108	8" C-Clamp

Magnetic Welding Holder



- » Strong magnet holds metal together at various angles
- » Helps increase welding precision

ITEM#	SIZE
HT1MH	Large
HT2MH	Medium

Stanley FatMax® Tape Rules



Reinforced
with Blade
Armor™
Coating

**MADE IN THE
USA**

- » Features 11" tape standout, 1-1/4" wide blade for easy readability
- » High-impact ABS case with rubber over mold and top-forward blade lock.

ITEM#	STYLE
HT725	25' Fat Max Tape
HT730	30' Fat Max Tape
HT740	40' Fat Max Tape



Open Reel Fiberglass Measuring Tape

- » Heavy-duty construction, high impact resistant ABS body
- » Numbers/graduations printed in black
- » Fiberglass tape will not rot, corrode or distort
- » Yellow case with two color tape, white side of tape has inch markings, yellow side has engineering scale
- » Comfortable rubber hand grip

ITEM#	DESCRIPTION
HT6820	200 ft. Tape
HT6830	300 ft. Tape

Stanley Magnetic LeverLock



NEW!

1" Blade Width

- » Magnetic tip for secure grip
- » Durable rubber shell
- » High-visibility case

ITEM#	STYLE
HT25MAG	25' Magnetic Leverlock



NEW!

**13 FT OF
BLADE
REACH
FOR
INCREASED
VERSATILITY**

DeWalt 30 FT Heavy-Duty Tape Measure

1-1/8" Blade Width

- » 30 ft. of tough blade coating
- » Wide base gives stability for measuring
- » 13 ft. of blade reach for increased versatility
- » Withstands heavy use
- » 1-1/8 blade width
- » Patented plastic with rubber slide lock for added protection
- » Durable blade coating withstands residential or jobsite conditions

ITEM#	STYLE
HT30DEW	30' Heavy-Duty Tape Measure

Heavy-Duty Aluminum Straight Edges



- » Easy reading inch scale graduations
- » Heavy-duty aluminum straight edge – 2" width
- » Available in 4', 6' and 8' length

ITEM#	STYLE
HT4004	48" Straight Edge
HT4006	72" Straight Edge
HT4008	96" Straight Edge



Pocket Caliper

- » Stainless steel slide caliper
- » 3" capacity
- » Decimal equivalents
- » Graduations: 32nds & mm
- » Inside/outside readings in inches and metric

ITEM#	DESCRIPTION
HT151545	Pocket Caliper



Vernier Caliper

- » 5" capacity in 16ths and 32nds with a vernier reading of 1/128th.

ITEM#	STYLE
HT151606	5" Vernier Caliper

16" x 24" Steel Framing Square

- » With inch/metric graduations
- » 24" x 2" body, 16" x 1-1/2" tongue, 1/16" thick
- » Permanently stamped numbers and 1/8" graduations. Durable protective epoxy finish to prevent rust.

ITEM#	STYLE
WSFS	



Soapstone

- » #1 select grade
- » Excellent for non-permanent metal marking
- » Available in 144 piece bulk packed boxes and convenient 4 packs (flat).

ITEM#	STYLE	PACKAGE
WSSSR	Round	144 Bulk
WSSSF	Flat	144 Bulk
WSSSC	Flat4-Pack with Holder	

Soapstone Holders



- » Round or Flat
- » Complete with soapstone and accepts soapstone listed above.
- » All metal construction

ITEM#	DESCRIPTION
WSSH	For Flat Soapstone
WSSHR	For Round Soapstone



Marking Crayons

- » For use on oily, wet, slick or dry surfaces.
- » Ideal for lumber, metal & concrete
- » Sold in packs of two crayons

ITEM#	COLOR
HT666012	Red
HT666062	Yellow

Measuring Wheel



- » 10" diameter single aluminum wheel
- » 9,999 feet measuring capacity
- » Displays measurement in feet and inches

ITEM#
HTMW3

Irwin Strait-Line Reel and Chalk



- » Fast, easy push button line release
- » Supplied with a 4 ounce bottle of blue chalk
- » Locking handle allows tool to be used as a plumb bob

ITEM #	DESCRIPTION
HT200	Reel and Chalk

Aervoe® Spray Marking Chalk

- » Not permanent
- » Safe on all surfaces



ITEM#	DESCRIPTION
HT215	White Chalk
HT218	Yellow Chalk

Mighty Marker



- » High-purity inks
- » Valve action allows you to write with paint on most surfaces
- » Patented valve action prevents leaks and allows you to write on most surfaces
- » Dual sided acrylic nib (bullet/chisel)
- » For permanent metal marking

ITEM#	COLOR
WSPMOR	Orange
WSPMR	Red
WSPMW	White
WSPMY	Yellow



Aluminum Levels

- » Available in 24" and 48"
- » Aluminum I-Beam frame
- » Top read window

ITEM #	DESCRIPTION
WSL24	24" Aluminum Level
WSL48	48" Aluminum Level



Magnetic Polycast® Torpedo Level

- » Strong, accurate 9" Polycast® frame
- » Strong holding magnetic edge and vials read plumb, level and 45°.

ITEM #	DESCRIPTION
WSMTL	9" Torpedo Level



Polycast® Post Level

- » Sturdy, high impact Polycast® construction
- » Durable vials read plumb and level
- » Establish plumb or level on decks, fences, support poles

ITEM #	DESCRIPTION
WSMPL	Post Level

Polysquare™ Rafter Square

- » Convenient conversion tables
- » Lightweight, but durable Polycast® material stands up to everyday use
- » Bright yellow color



ITEM #	DESCRIPTION
WSRL	Rafter Square

Magnetic Polycast® Protractor

- » Magnetic base and back for Hands-Free reading on Ferrous surfaces
- » Easy reading dial with adjustable angle pointer.
- » Built-in angle pitch calculator on back.
- » POLYCAST® construction.



ITEM #	DESCRIPTION
WSMP	Magnetic Protractor

Pipe Wrap

- » Manufactured out of flexible gasket material
- » Reasonably resistant to heat and cold.



ITEM #	SIZE	PIPE SIZE
WS152	2-1/2" W x 24" L	1" to 3"
WS164	4" W x 48" L	3" to 6"
WS176	4" W x 72" L	3" to 10"



Contour Gauge

- » Can duplicate any profile
- » The pins slide to conform to irregular surfaces.

ITEM #	SIZE
HT151693	6" x 3-1/2"



Combination Square

- » Twelve-inch steel blade with pencil guide uses self-aligning drawbolt for easy blade installation. Machined head with acrylic vial.

ITEM #	DESCRIPTION
WSTS	12" Combo. Square

Pipe Guides

Magnetic!



THREE SIZES

- » Two double-sided templates create four different cutting guides at 45°, 90°, & 22.5°
- » Flexible with a metal, magnetic "forever hinge" that is almost indestructible
- » Lightweight & durable

ITEM #	DESCRIPTION
WS178S	Fits 1-7/8" OD pipe
WS238S	Fits 2-3/8" OD pipe
WS278S	Fits 2-7/8" OD pipe
WS312S	Fits 3-1/2" OD pipe
WS412S	Fits 4-1/2" OD pipe

Fast 2K

Fast Setting
Foam for Posts



The Alternative to Concrete for Setting
Fence Posts in Less than 15 Minutes



- » Mixes in 30 Seconds & Sets within 15 Minutes
- » Waterproof Protection - Does Not Absorb Water Like Concrete
- » Adheres to Metal, Wood & Vinyl Posts
- » No Hauling Heavy Concrete Bags
- » No Water Needed & No Messy Mixing
- » One Bag = 100 lb of Concrete

ITEM

MCSAFSF



50 lb. Bucket Anchoring Cement

Please Note that Different Brands are Stocked at Each of Our Locations. Contact Your Location to Determine the Brand.

Just add water

A pourable cement that develops strength greater than concrete and expands as it hardens. Sets in 10-30 minutes.

- » Use for setting bolts, handrails, or metal items to be anchored in concrete
- » Ideal for repairing loose metal railings

ITEM#

MCSA50

SIZE

50 lb. Bucket

For Cured Concrete & Masonry, Use a Segmented Diamond Blade
Find it on Page 222



Wooden Handle Wire Hand Brushes



ITEM#

WSHS26

STYLE

Short Handle

WSHB29

Long Handle

Caution Barrier Tape



- » Bright yellow plastic tape
- » 3" wide
- » 300 ft. roll

ITEM#

HTMC1L

DESCRIPTION

3" x 300 ft. Roll

Wiping Rags



Great for shop use

- » Made from 15 in. x 10 in. white cotton T-shirt material
- » Box of 40 rags

ITEM#

HT4240DCW

DESCRIPTION

Box of 40 Rags

3 Piece Wire-Tooth Brush Set

Includes

- (1) stainless steel wire brush
- (1) brass wire brush
- (1) black plastic bristle brush



ITEM#

WSHS3TB

Multi-Purpose Steel Tie Wire

3-1/2 lb roll



ITEM#

MCTW312

DESCRIPTION

16 Gauge Tie Wire



Barbecue Pit Thermometer

High quality thermometer provides a finishing touch to BBQs and smokers.

- » Threaded stem for easy installation
- » Large, easy-to-read dial
- » Quantity discounts available

ITEM #	DESCRIPTION
MC1T	Barbecue Pit Thermometer

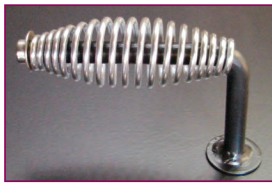

6" Spring Handle With 1/2" steel bar and cap

- » Constructed of Type 302 stainless steel wire
- » Measures 6 inches length with a 1-1/2" diameter/ weighs 6 oz.
- » Spring handle is attached to 1/2" steel bar with push nut cap

ITEM #	DESCRIPTION
MC1SSHD	6" Stainless Spring Handle

Call Us for Large Diameter Pipe

Build Your Own Barbeque Pit



We
Cut to
Size

770-416-6999

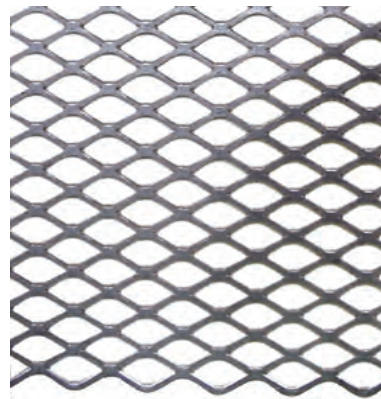

Precut Expanded Metal

- » 3 ft. x 2 ft.
- » 3/4" x #9
- » Flattened

ITEM #	DESCRIPTION
MCBBQ1	Precut Expanded Metal

High Temperature Black Spray Paint

NOTE:

Must be heat cured at a minimum temperature of 400F for two hours

Do not use a primer



Perfect for Barbeque Pits

- » Heat resistant spray paint designed to withstand temperatures up to 1200F on a continuous basis
- » Creates a porcelain-like bond at high temperatures
- » Resists peeling, loss of adhesion, and blistering
- » Fast drying
- » 12 oz cans; sold individually or 12-can boxes

ITEM#	COLOR
SP1614	High Heat Black



Firebox Black Heat Resistant Enamel

- » Temperature resistance: 850° F
- » For barbecue grills, stoves and fireplaces
- » Fast drying; prevents rust



ITEM#	SIZE
SP23H	1 Gallon Can

8" Wheel with Solid Rubber Tire



- » 8" diameter x 1-3/4" Wide
- » 5/8" bore
- » Axle not included

ITEM #	DESCRIPTION
HA37RT	8" Rubber Tire/Wheel

5/8" All-Thread Axle, Washers and Nuts

- » Plated
- » 36" length

ITEM #	DESC.
HLAT583	Axle Rod
HLAT58N	Hex Nut
HLAT58W	Washer





The Wrought Iron Painter

- » Paints two sides of a surface at one time
- » Paints wrought iron, security bars, pipe fence, cable, wood turnings, etc
- » It's faster, neater, and easier than a brush or mitt

ITEM#	DESCRIPTION
MCPWP32	Painter
MCPWP32R	2-Roll Refill

Foam Pipe Painter

Specially designed to paint small diameter pipe quickly and easily.

ITEM#	DESCRIPTION
MCPWP39	Foam Pipe Painter



Foam Trim Roller

- » 3" roller width
- » Great for small touch-up projects.

ITEM#	DESCRIPTION
MCPWP5	Foam Trim Roller

Foam Brushes

- » Many uses
- » Great for touching up hard-to-get corners
- » Available in 1", 2", 3" and 4" widths

ITEM#	SIZE
MCPWPB1	1"
MCPWPB2	2"
MCPWPB3	3"
MCPWPB4	4"

Touch-Up Chip Brushes

- » Economy/single use
- » Can be used with all paints
- » Wood handle
- » Available in 1", 2", 3" and 4" widths

ITEM#	DESCRIPTION
MCPSPB1	1" Chip Brush
MCPSPB2	2" Chip Brush
MCPSPB3	3" Chip Brush
MCPSPB4	4" Chip Brush

Paint Mitt

- » Great for touch-up work

ITEM#	DESCRIPTION
MCPSP1PM	Paint Mitt

Disposable Dust and Particle Mask

- » Complete with elastic strap
- » Sold individually or in 50 pc boxes
- » Helps protect against non-toxic dusts and spray paints

ITEM#	DESCRIPTION
WS1501	

Blue Painter's Grade Masking Tape

Designed for the professional

Full crepe insures conformability on curved and irregular surfaces.



ITEM#	STYLE
MCP455115	2 in. x 60 yd.

Paint & Pesticide Respirator



SAFETY WORKS

Includes Pair of Respirator Cartridges



Replacement Cartridges Sold Separately

- » Flexible face piece material provides excellent face-to-respirator seal
- » Headband swivels on hinges for improved comfort and fit
- » Respirator & long-life pre-filters are certified by NIOSH as an R95/ OV respirator

ITEM #	DESCRIPTION
WS152241	Standard Size Half Mask
WS152245	Replacement Cartridge (Pair)

NEED A PRICE?
 Give Us a Call
 770-416-6999 Tucker
 770-297-6675 Gainesville
www.steelmartatlanta.com

2.3mm Gravity Feed HVLP Spray Gun



- » Brass Fluid & Air Nozzle
- » 600cc Plastic Paint Cup
- » Includes locking air regulator with gauge

Air Inlet: 1/4" Operating pressure: 15 - 45 P.S.I.
Avg. Air consumption: 7.0 - 9.0 C.F.M.

ITEM#

MCP200

2.0mm Gravity Feed HVLP Spray Gun



Includes locking pressure regulator with gauge

- » 1000 ml aluminum paint cup
- » Spray pattern control knob on side

Air Inlet: 1/4" Operating pressure: 15 - 45 P.S.I.
Avg. Air consumption: 7.0 - 9.0 C.F.M.

ITEM#

MCP100

Economy Spray Paint

Available in 14 Colors



- » Quick drying multi-purpose spray enamel
- » Bare or rusted surfaces should be cleaned and primed.
- » Six 12 oz. cans per case

ITEM#

COLOR

SP1115	Gray Primer
SP1112	Flat White
SP1124	Gloss Black
SP1134	Gloss Yellow
SP114	Gloss Red
SP115	Gloss Gold
SP1156	Gloss Blue
SP118	Gloss Green
SP9839	Gloss Pink
SP9848	Gloss Orange
SP9889	Gloss Purple
SP161617	Fluorescent Orange
SP161618	Fluorescent Red
SP161620	Fluorescent Green

Economy Air Spray Gun



- » 70-90 PSI
- » Recommended air compressor is 1-1/2 HP
- » All purpose gun/cup for spraying most types of latex, oil or water based paints

ITEM#

MCPCL3030

Spray Can Trigger Handle



2-Finger Trigger

- » Use with any spray paint can
- » Safety lock prevents accidental paint discharge

ITEM#

HT241

DESCRIPTION

Grip Handle

PVC Air Hose



- » 50 ft. length
- » Heavy duty reinforcement
- » 0° to 130° F working temperature
- » 300 PSI maximum working pressure

ITEM#

MCPCL3850

DESCRIPTION

50 ft. PVC Hose

Blacksmith Brand™ Touch-Up Spray Paint

- » Available in exact color match for BlackSmith Black
- » Stocked individually or in 12 can case



ITEM#

SPSP2100

SIZE

16 oz.

COLOR

Black

Seymour Primers

Excellent Resistance to Heat and Corrosion while being Sandable



VOC Compliant



- » Fast drying
- » Provides maximum rust protection and adhesion
- » Use with lacquer, enamel and acrylic paints

ITEM#	COLOR
SP203	Gray Primer
SP205	Red Oxide Primer
SP9816	Black Primer

Seymour Shiny Galv

- » Fast-drying formula dries to a tough, permanent hard coat
- » Electrochemical galvanic action keeps on protecting even if scratched.
- » Shiny Galv may be repainted or left as is. It also doubles as a weld-through primer.



ITEM#	SIZE	DESCRIPTION
SP12GS	16 oz.	Shiny Galv

Seymour Spray-Galv Weld-Thru Primer

- » Dried paint film contains a minimum of 90% zinc
- » Electrochemical galvanic action continues to protect even if scratched



ITEM#	SIZE	DESCRIPTION
SPWSSG	16 oz.	Spray-Galv Primer

High Temperature Black Spray Paint



NOTE:

Must be heat cured at a minimum temperature of 400F for two hours. Do not use a primer.

- » Heat resistant spray paint designed to withstand temperatures up to 1200F on a continuous basis
- » Creates a porcelain-like bond at high temperatures
- » Resists peeling, loss of adhesion, and blistering
- » Fast drying
- » 12 oz cans; sold individually or 12-can boxes

ITEM#	COLOR
SP1614	High Temperature Black

Heat-Resistant Engine Enamel Spray Paint



Chrome Aluminum (Metallic)

Fast Dry spray paint that restores engines to original factory color

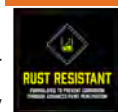
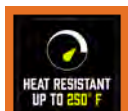

- » Does not crack or peel
- » Interior/Exterior
- » Works on metal, fiberglass & wood
- » Dries to tack-free in 5 minutes, 20 minutes to recoat
- » Up to 15 sq ft of coverage per can

For maximum protection, rusted metal surfaces should be wire brushed and primed with the Spruce primers

ITEM#	COLOR
SP1402	Heat Resistant Spray Paint

All Purpose Spray Enamel Paint & Primers



Sold Individually or in 12-can boxes



- » Affordably priced
- » Durable coating that protects against rust and will not crack or peel
- » Resists heat up to 250° F
- » Dries to touch in 5 minutes 30 minutes to recoat
- » Up to 15 sq ft of coverage per can
- » 12 oz. cans

ITEM#	COLOR
SP100	White - Gloss
SP101	White - Flat
SP110	Black - Gloss
SP117	Black - Flat
SP140	Green
SP120	Metallic Silver
SP113	Gray
SP121	Metallic Gold
SP9831	Clear-Gloss
SP130	Red
SP151	Yellow
SP160	Blue
SP180	Brown
SP1654	Stainless Steel

Midnight Black



Darkens Steel without Special Equipment

Example shown is Midnight Black and Copper Plate applied to steel hand rail

- » Darkens steel and non-stainless steel alloys at room temp without the need for any special equipment
 - » Apply by spray, immersion, or brush
 - » May be burnished to lighten intense darkness before sealing
- » Finished parts may be quick dried and sealed or allowed to oxidize. Oxidation will alter the colors and textures

ITEM#	SIZE
MCPR52	1 Quart
MCPR521G	1 Gallon

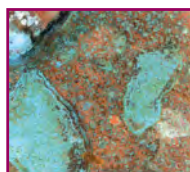

Patina on copper sheet



Patina on copper coating on plaster cast



Patina on bronze casting



Patina Oxidizer

- » For copper, brass, bronze and our metallic coatings
- » Salt-water based solution will oxidize on copper and copper alloys
- » Produces a wide variety of blue, green, turquoise, purple and other colors

ITEM#	SIZE
MCPR41	1 Quart
MCPR411G	1 Gallon

Light Pewter



- » Creates an authentic looking pewter finish to various shades of gray

ITEM#	SIZE
MCPR48	1 Quart
MCPR481G	1 Gallon

Dark Pewter

- » Darkens most metals
- » Can be burnished to create highlights
- » Darkens metal to a higher degree than Light Pewter
- » Works with Copper Plate to create antique burnished finish on steel



Dark Pewter on Steel



Copper Plate Over Dark Pewter on Steel

ITEM#	SIZE
MCPR50	1 Quart
MCPR501G	1 Gallon

Auburn Insta-Rust

Apply Insta-Rust for a Modern Industrial Look



- » Provides a rust finish on steel and steel alloys in hours
- » Both a copper plating solution as well as a rusting agent
- » Develops into deep, brown rust, while retaining a hint of copper

ITEM#	SIZE
MCPR46	1 Quart
MCPR461G	1 Gallon

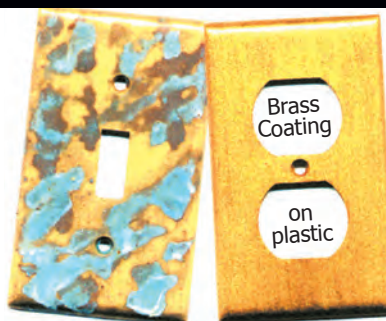

Brass Coating with patina



Brass Coating

- » Contains real brass flakes
- » Works with Patina Oxidizer
- » Unsealed, this finish will tarnish or patina like brass

ITEM#	SIZE
MCPR47	1 Quart
MCPR471G	1 Gallon

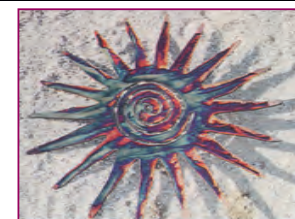

Rainbow Torch

- » Authentic torched metal colors without using the torch!
- » Used in conjunction with Copper Plate or Insta-Rust to create a rainbow of colors on steel and steel alloys
- » No special equipment or skills to apply

ITEM#	SIZE
MCPR43	1 Quart
MCPR431G	1 Gallon

Gun Metal Blue



- » Colors range from steely gray to, dark blue/black
- » Will work with steel, steel alloys and many other metals
- » Color range achieved by time treated or immersed

ITEM#	SIZE
MCPR51	1 Quart
MCPR511G	1 Gallon

Gold Coating



- » Contains real copper flakes
- » Works with Patina Oxidizer
- » Unsealed, it will tarnish or patina like copper

ITEM#	SIZE
MCPR42	1 Quart
MCPR421G	1 Gallon

Copper Plate



- » Requires no plating equipment or special training
- » Works on steel and steel alloys
- » May be applied by spray or immersion

ITEM#	SIZE
MCPR40	1 Quart
MCPR401G	1 Gallon

Gloss Acrylic Sealer



- » Preserves finishes
- » A glossy, clear coat sealer

ITEM#	SIZE
MCPR49	1 Quart
MCPR491G	1 Gallon

Rust Arrest



- » Stops chemical reaction
- » Neutralizing agent that helps neutralize oxidation on pieces treated with our metal finishes
- » Not for use on metallic coatings
- » Recommended for use with copper plate and rainbow torch

ITEM#	SIZE
MCPR45	8 Ounces
MCPR45Q	1 Quart

Spra-Tool® Disposable Spray Gun Kit



- » Complete with interchangeable tips for fine, regular or high volume delivery.
- » Good for most liquids including acrylic, latex and epoxy paints, chemicals, pesticides and more.
- » Resealable jar and fast easy clean up.

ITEM#	DESCRIPTION
HT8209	Spray-Tool Kit
HT8211	Extra Power Pack
HT8212	Jar with Cap

LiftMaster®

LA400 DC Linear 24V Residential Swing Gate Operator

Single Arm Package

- SWING GATE UP TO 16 FT / 550 LBS
- RESIDENTIAL USE
- POST MOUNT
- PHOTO EYE INCLUDED
- AC POWER

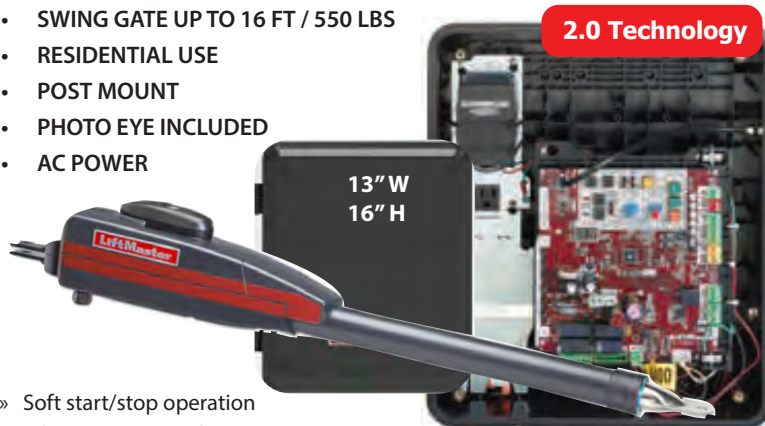

- » Soft start/stop operation
- » Inherent & external obstruction sensing
- » Timer-to-close
- » Keyed manual disconnect

ITEM #	DESCRIPTION
GTELA400PKGDC	Single Arm Package

What's Included in the Box

ITEM	ITEM NUMBER
Arm	GTELA400DC
Photo Eye	GTELMRRU
Radio Receiver	Built in Board
Control Box	GTELA400CONTDC
Batteries (2)	GTEBT12
Transformer	GTA8807

Optional Accessories

ITEM	ITEM NUMBER
Secondary Arm	GTELA400DCS40
Loop Detector	GTANP2ESL
Keypad	GTX877MAX
Exit Probe	GTACP4
Remote	GTX811
Smartphone Access	GX828LM

LA412 Solar Powered 12V Residential Swing Gate Operator

Single Arm Package

- SWING GATE UP TO 16 FT / 550 LBS
- RESIDENTIAL USE
 - » DC motor - slow start/stop operation
- POST MOUNT
 - » Inherent & external obstruction sensing
- PHOTO EYE INCLUDED
 - » Keyed manual disconnect
- SOLAR POWER
 - » Timer-to-close



ITEM #	DESCRIPTION
GTELA412PKGDC	Single Arm Package* *includes 10 Watt Solar Panel

What's Included in the Box

ITEM	ITEM NUMBER
Arm	GTELA412DC
Photo Eye	GTELMRRU
Radio Receiver	Built in Board
Control Box	GTELA412CONTDC
Batteries (2)	GTEBT12
Solar Panel	GTS210

Optional Accessories

ITEM	ITEM NUMBER
Secondary Arm	GTELA412DCS40
Loop Detector	GTANP2ESL
Keypad	GTX877MAX
Exit Probe	GTACP4
Remote	GTX811
Smartphone Access	GX828LM

LiftMaster

LA500 DC Residential/Light Commercial Swing Gate Operator

Single Arm Package

2.0 Technology

- SWING GATE UP TO 18 FT / 600 LBS or 12 FT / 1200 LBS
- HEAVY DUTY RESIDENTIAL / LIGHT COMMERCIAL USE
- POST MOUNT
- PHOTO EYE INCLUDED
- AC POWER
- » Power: 110V or 220V single phase
- » 300 cycles per day
- » Receiver holds up to 50 remotes
- » Travel speed: 90° opening in 15-17 seconds
- » HomeLink® compatible
- » Keyed manual disconnect
- » Weight: 45 lbs

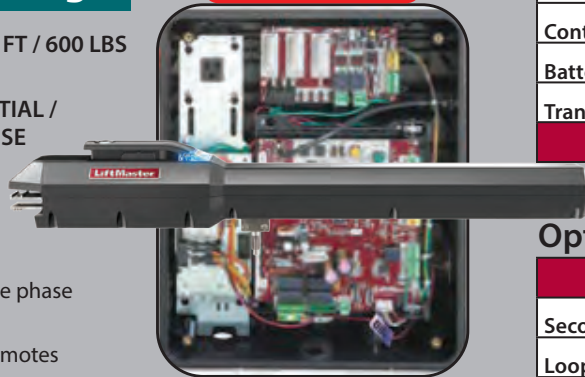

ITEM #	DESCRIPTION
GTELA500PKGDC	Single Arm Pkg (includes arm & control box)

What's Included in the Box

ITEM	ITEM NUMBER
Arm	GTELA500DC
Photo Eye	GTELMRRU
Radio Receiver	Built in Board
Control Box	GTELA500CONTDC
Batteries (2)	GTEBT12
Transformer	GTELA500HDTKITSTD

Optional Accessories

ITEM	ITEM NUMBER
Secondary Arm	GTELA500DCS40
Loop Detector	GTDLOOPDTM
Keypad	GTXWKP5
Exit Probe	GTACP4
Remote	GTX811
Smartphone Access	GX828LM

RSW12VDC Residential/Light Commercial Swing Gate Operator

Single Arm Package

- SWING GATE UP TO 16 FT / 600 LBS
- RESIDENTIAL / LIGHT COMMERCIAL USE
- PAD / STAND MOUNT
- PHOTO EYE INCLUDED
- BATTERY BACKUP INCLUDED
- AC POWER*
(*option to be solar powered)
- » Cycling up to 250 times per day
- » On-board radio receiver; up to 50 remotes
- » Soft start/stop operation
- » Inherent obstruction sensing
- » External obstruction sensing inputs
- » One 7AH battery standard
- » Timer to close



2.0 Technology

What's Included in the Box

ITEM	ITEM NUMBER
Photo Eye	GTELMRRU
Radio Receiver	Built in Board
Control Board	GTEDCBDU
Batteries (1)	GTEBT12
Transformer	GTA8807

Optional Accessories

ITEM	ITEM NUMBER
Loop Detector	GTANP2ESL
Keypad	GTXWKP5
Exit Probe	GTACP4
Remote	GTX811
Smartphone Access	GX828LM

ITEM #	DESCRIPTION
GTERSW12VDC	12 Volt Residential Operator

LiftMaster®

Elite Series CSW 24V Commercial DC Swing Gate Operator Package

- SWING GATE UP TO 18 FT / 600 LBS or 12 FT / 1200 LBS
- COMMERCIAL USE
- PAD MOUNT
- PHOTO EYE INCLUDED
- AC POWER

2.0 Technology

Monitored Safety Inputs
Come standard with the CSW24U.

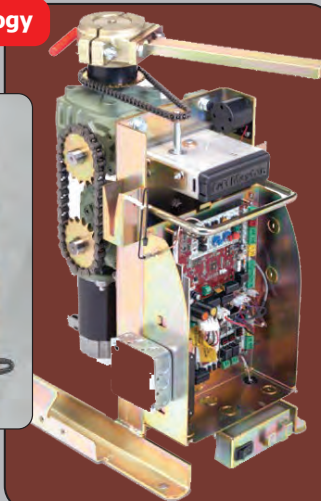
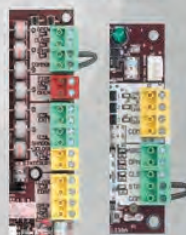

ITEM #	DESCRIPTION
GTECSW24VDC	24 VDC Commercial Operator

What's Included in the Box

ITEM	ITEM NUMBER
Photo Eye	GTELMRRU
Radio Receiver	Built in Board
Control Board	GTEDCBDU
Batteries (2)	GTEBT12

- » Power: 110V or 220V single phase
- » Travel speed: 90° in 13-15 seconds

Optional Accessories

ITEM	ITEM NUMBER
Loop Detector	GTELOOPDETLM
Keypad	GTXWKP250
Exit Probe	GTACP4
Remote	GTX811
Smartphone Access	GX828LM
Fire Box	GTFBMS

Nice Apollo
Gate Operators

1500 12VDC Residential Swing Gate Operator Single Arm Package

Control Box Includes the 636 Circuit Board



((433.92 MHz))

- SWING GATE UP TO 16 FT / 600 LBS
- RESIDENTIAL USE
- POST MOUNT
- AC or SOLAR* or BATTERY POWER
(*12v system is solar compatible)

Optional Accessories

ITEM	ITEM NUMBER
Secondary Arm	GTS816X1K
Loop Detector	GTANP2ESL
Keypad	GTSMX5151
Exit Probe	GTACP4
Remote	GTSN2
Smartphone Access	GTTNEXX

What's Included in the Box

ITEM	ITEM NUMBER
Radio Receiver	GTS318N
Control Box	GTS1500

Required: Must Purchase Separately

ITEM	ITEM NUMBER
Arm	GTS8161K
Transformer	GTS404
or	
Solar Panel	GTS210
Batteries (1)	GTA12V

ITEM #	DESCRIPTION
GTS1500	Control Box w/ 636 Board



Viking R-6 Residential Swing Gate Operator Package

- SWING GATE UP TO 14 FT / 700 LBS
- RESIDENTIAL USE
- PAD MOUNT
- AC POWER
- » VFlex control board with on-board diagnostics LCD display
- » Chassis design for easy control viewing
- » Built in heater
- » Temperature management system
- » Integrated true standard battery backup
- » Convenient fuse access
- » LED status indicators
- » Main Power Source: 115/230 AC Single Phase / Operational Voltage: 24 DC
- » Battery Backup: 400 Full Continuous Duty Cycles (600 lbs.)



What's Included in the Box

ITEM	ITEM NUMBER
Control Board	GTVFLEXPCB
Transformer	GTVDUTT10
Batteries (2)	GTEBT12

Required: Must Purchase Separately

ITEM	ITEM NUMBER
Receiver	GTADC5150
Photo Eye	GTANR10K

Optional Accessories

ITEM	ITEM NUMBER
Loop Detector	GTANP2ESL
Keypad	GTADC5200
Exit Probe	GTACP4
Remote	GTA3089
Smartphone Access	GTVAMONITOR

ITEM#	DESCRIPTION
GTVAR6NX	R-6 Swing Gate Operator

Nice Apollo Gate Operators

Titan 12 VDC Residential Swing Gate Operator Single Arm Package



Control Box Includes the 1050 Circuit Board



((433.92 MHz))

- SWING GATE UP TO 20 FT / 600 LBS
- RESIDENTIAL USE
- POST MOUNT
- AC or SOLAR or BATTERY POWER

ITEM #	DESCRIPTION
GTSTKAC1	AC POWER PKG
GTSTKS1	SOLAR POWER PKG

What's Included in the Box

ITEM	ITEM NUMBER
Arm	GTSTITAN
Photo Eye	GTANR50
Radio Receiver	GTS1050RV
Control Box	GTS15501K
Transformer	GTS404
or	
Solar Panel	GTS210

Optional Accessories

ITEM	ITEM NUMBER
Secondary Arm	GTSTITAN
Loop Detector	GTANP2ESL
Keypad	GTSMX5151
Exit Probe	GTACP4
Remote	GTSN2
Batteries	GTA12V
Smartphone Access	GTTNEXX

LiftMaster®

RSL12VDC Residential / Light Commercial Slide Gate Operator with Battery Backup

Package

- SLIDE GATE UP TO 25 FT / 800 LBS
- RESIDENTIAL / LIGHT COMMERCIAL USE
- PAD MOUNT
- PHOTO EYE INCLUDED
- SAFETY EDGE INCLUDED
- BATTERY BACKUP INCLUDED
- AC POWER*
(*option to be solar powered)
- » External manual disconnect
- » Surge/spike protection 3-year warranty
- » Inherent / extern obstruction sensing
- » Electronic brake
- » UV stabilized cover
- » Timer-to-close: 0-180 seconds

2.0 Technology



ITEM #	DESCRIPTION
GTERSLS12UL	12 Volt Residential Operator

What's Included in the Box

ITEM	ITEM NUMBER
Photo Eye	GTELMRRU
Radio Receiver	Built in Board
Control Board	GTEDCBDU
Batteries (1)	GTEBT12
Transformer	GTA8807
Safety Edge	GTEL506AL
25' Chain	GTA41C

Optional Accessories

ITEM	ITEM NUMBER
Loop Detector	GTANP2ESL
Keypad	GTXWKP5
Exit Probe	GTACP4
Remote	GTX811
Smartphone Access	GX828LM

LiftMaster®

CSL24VDC Commercial DC Gate Operator

Package

- SLIDE GATE UP TO 50 FT / 1500 LBS
- COMMERCIAL USE
- PAD MOUNT
- PHOTO EYE INCLUDED
- SAFETY EDGE INCLUDED
- BATTERY BACKUP INCLUDED
- AC POWER*
(*option to be solar powered)
- » External manual disconnect
- » Surge/spike protection 3-year warranty
- » Inherent / extern obstruction sensing
- » Electronic brake
- » UV stabilized cover
- » Timer-to-close: 0-180 seconds

2.0 Technology



ITEM #	DESCRIPTION
GTECSL24UL	24 VDC Commercial Operator

What's Included in the Box

ITEM	ITEM NUMBER
Photo Eye	GTELMRRU
Radio Receiver	Built in Board
Control Board	GTEDCBDU
Batteries (2)	GTEBT12
Safety Edge	GTEL506AL
25' Chain	GTA41C

Optional Accessories

ITEM	ITEM NUMBER
Loop Detector	GTELOOPDETLM
Keypad	GTXWKP250
Exit Probe	GTACP4
Remote	GTX811
Smartphone Access	GX828LM



Viking K-2 Residential Slide Gate Operator

Package

- SLIDE GATE UP TO 30 FT / 700 LBS
- RESIDENTIAL USE
- PAD MOUNT
- AC POWER

- » VFlex control board with on-board diagnostics LCD display and push-button digital limits setup
- » Built in heater
- » True standard built in battery backup
- » Convenient fuse access
- » LED status indicators
- » Operational Voltage: 24 DC
- » Main Power Source: 115/230 AC Single Phase
- » Battery Backup: 100 Full Continuous Duty Cycles (700 lbs.)

Requires Two External Safety Devices



What's Included in the Box

ITEM	ITEM NUMBER
Control Board	GTVFLEXPCB
Transformer	GTVDUTT10
Batteries (2)	GTEBT12
25' Chain (Nickle Plated)	GTA40CNP

Required: Must Purchase Separately

ITEM	ITEM NUMBER
Receiver	GTADC5150
Photo Eye	GTANR10K

Optional Accessories

ITEM	ITEM NUMBER
Loop Detector	GTANP2ESL
Keypad	GTADC5200
Exit Probe	GTACP4
Single-Button Remote	GTA3089
Smartphone Access	GTVAMONITOR

ITEM#	DESCRIPTION
GTVAK2NX	Slide Gate Residential Operator



Eagle I 1/2 HP Residential Fail Safe Slide Gate Operator

Package



NOW INCLUDES TWO REMOTES IN THE PACKAGE

- SLIDE GATE UP TO 18 FT / 300 LBS
- RESIDENTIAL USE
- PAD MOUNT
- NO PHOTO EYE NEEDED

- » 24 VAC Auxiliary Power Outputs
- » Auto-Close Timer (1-60 sec.)
- » Gate Operation: 12"/sec Travel
- » 20" H x 15" W x 12" D
- » Shipping Weight: 75 lbs

NOTE: Will Operate Without Photo Eye but Use of One is Recommended



What's Included in the Box

ITEM	ITEM NUMBER
Radio Receiver	GTZEG650
Control Board	GTZEG002
20' Chain	GTA41CNP
2-Button Remotes (2)	GTZEG642

Optional Accessories

ITEM	ITEM NUMBER
Photo Eye	GTZEG360
Loop Detector	GTANP2ESL
Keypad	GTZEG654
Exit Probe	GTACP4
Smartphone Access	GTTNEXX

ITEM #	DESCRIPTION
GTZ1RES	

EXIT PROBES

CP-4 Automatic Gate Opener

Free Exit System



All-In-One Unit Without External Circuit Board

Hook Wires Directly to Gate Operator

Works with Electric or Solar Gates

- » Open gates automatically; Free Exit
- » Self-Contained
- » Universal voltage and N/O or N/C relays make CP-4 compatible with any power and solar gate
- » Lowest standby current in the industry by 95%
- » Sensor Sensitivity Adjustment



Compatible with ALL Gate Operators Listed in this Catalog

ITEM #	DESCRIPTION
GTACP4	All in One Free Exit Opener

PHOTO EYES

Monitored Retro-Reflective Photo Eye

Monitored UL 325-2016 Compliant Built-In Heater!



- » Powerful enough to detect obstructions and communicate with the reflector up to 50 ft
 - » Requires power only on one side of the installation
- Compatible with

LiftMaster LA 400 DC on Page 240

LiftMaster LA412 Solar on Page 240

LiftMaster RSW12VDC on Page 241

LiftMaster CSW 24V on Page 242

LiftMaster RSL12VDC on Page 244

LiftMaster CSL24VDC on Page 244

ITEM#	DESCRIPTION
GTLMRRU	Retro-Reflective Photo Eye

Photo Eye Kits

IR LED Kit includes:

Infrared photo eye
Reflector / Mounting bracket / Hardware

- » 12V AC/DC to 250V AC
- » Range: 35 ft/50 ft

Compatible with the Viking R6 on Page 243 and the Viking K2 Gate Operator on Page 245

ITEM #	DESCRIPTION
GTANR10K	35ft 10K Reflective PhotoEye
GTANRP	Polarized Reflective PhotoEye

EG360 Monitored / Non-Monitored Photo Eye

- » UL 325 Compliant
- » Built for UL and Non-UL Gate Operators
- » Up to 50-foot sensor range

Kit includes:

Photo eye / Removable hood
Reflector / Mounting bracket
Hardware



Compatible With:
All Eagle Gate Operators

Compatible with the Eagle I 1/2 HP on Page 245

ITEM #	DESCRIPTION
GTZEG360	Photo Eye

MOFB Moon Photo Eye



- » Uses Apollo's Blue Bus communication system
- » Reveals obstacles situated on optical axis between transmitter / receiver
- » Easily installed with two wires
- » Minimal maintenance

Compatible with the Titan 12VDC Gate Operator on Page 243

ITEM #	DESCRIPTION
GTSMOFB	Photo Eye

Omron Photoelectric Safety Eye: E3K-R10K4



Includes:
Reflector
Mounting Brackets

- » Up to 32 ft range
- » 24 - 240 V AC/DC

Compatible With:
Operators using 10k / NO / NC

Compatible with
LiftMaster LA 400 DC on Page 240
LiftMaster LA 500 DC on Page 241
LiftMaster CSW 24 V on Page 242
Viking R6 on Page 243
LiftMaster CSL24VDC on Page 244
Viking K-2 on Page 245
Eagle I on Page 245

ITEM #	DESCRIPTION
GTAMRON	Omron Photoelectric Eye

LOOP DETECTORS

Tinned Copper Loop Wire



- » 18 gauge stranded XLPE tinned copper loop wire
- » Sold in 1000 ft. rolls

ITEM #	DESCRIPTION
GTAW14	Black 18 ga. Loop Wire

Preformed Loops



- » 50 ft. lead
- » Used under concrete or other pave-over applications

Stocked in 4' x 8' and 8' x 12'.
Other sizes available upon request

ITEM #	DESCRIPTION
GTAL48	4 ft. x 8 ft. Size
GTAL812	8 ft. x 12 ft. Size

Single Channel Single Output / Low Power Mini Loop Detector



Extremely Small Form

- » 4 selectable sensitivities & frequencies
- » Wrong voltage protection
- » Separate power/fault and detect indicators
- » Automatic sensitivity boost
- » Power supply requirement: 10 to 30V DC or AC, 1ma nominal
- » Screw terminal connections for power, loop and output

Compatible with ALL Gate Operators Listed in this Catalog

ITEM #	DESCRIPTION
GTANP2ESL	Sngl Channel Loop Detector

Plug-In Loop Detector



Compatible with Security+ 2.0™

- » 8 sensitivity settings
- » Boost for high-profile vehicles
- » 4 frequency options
- » Plug-in connector; No wiring needed
- » 12VDC/3mA low power draw
- » Includes diagnostic and test feature
- » Prevents the gate from closing on a vehicle in the path
- » Power Efficient for maximum cycles on Battery Backup

Compatible with
LiftMaster LA 500 DC on Page 241
LiftMaster CSW 24V on Page 242
LiftMaster CSL24VDC on Page 244

ITEM #	DESCRIPTION
GTELOOPDETLM	Plug-In Loop Detector

SOLAR PANELS and BRACKETS

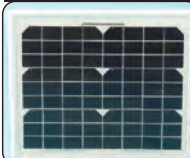

Panels

From 5 to over 40 watt charging capacity
Maintains gate operator batteries in remote locations

ITEM #	VOLT	WATT	DIMENSIONS	BRACKET INFORMATION
GTS201	12	5	12.9" x 8.5"	Brackets Included in Box
GTS210	12	10	14.5" x 12.2"	Brackets Included in Box
GTS220	12	20	22" x 14.2"	Brackets Included in Box
GTS240	12	45	26.2" x 21.2"	Brackets Not Included

ITEM #	VOLT	WATT	DIMENSIONS	BRACKET INFORMATION
GTS22024	24	20	22.9" x 14.2"	Brackets Included in Box
GTS24024	24	45	26.2" x 21.2"	Brackets Not Included

ITEM #	DESCRIPTION
GTSS10L24V	Solar Regulator for 24V or 12Vwv

Brackets

- » Brackets Do Not Include Hardware to Mount on Surface

ITEM #	BRACKET INFORMATION
GTS24BK	Aluminum Brackets for GTS240 / GTS24024
GTS208	Flatbar Metal Brackets for GTS201/ GTS210/ GTS220 / GTS22024

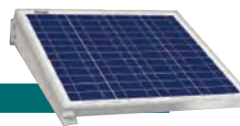

Seven Day Timer



Choose Between a 12 or 24 Hour Clock Format to Program Open/Close Times

- » Back-up rechargeable battery for power outages or brown outs
- » Flexible programming with 16 ON/OFF events per day
- » Large display and push-buttons for easy operation
- » Battery backup for power outages
- » DIN rail mount installation
- » Three power supply options
- » Manual override for ON or OFF operation



GTADTM12 12 Volt
Compatible with
LiftMaster RSW 12VDC on Page 241
LiftMaster LA412 Solar on Page 240
NICE/Apollo 1500 12VDC on Page 242
NICE/Apollo Titan 12 VDC on Page 243
LiftMaster RSL 12VDC on Page 244

GTADTM24
24 Volt AC/DC
Compatible with
LiftMaster LA400 DC on Page 240
LiftMaster 500 DC on Page 241
LiftMaster CSW 24V on Page 242
Viking R-6 on Page 243
LiftMaster CSL 24VDC on Page 244

ITEM #	DESCRIPTION
GTADTM12	12 Volt Input
GTADTM24	24 Volt AC/DC Input

KEYPADS

RIDGE_{2.0}

Wireless Keypad & Transceiver



No Wires Mean Freedom

This System Can Be Located and Mounted Anywhere

- » Ridge Wireless™ technology allows two-way wireless connection, for a more versatile/ responsive system
- » 500 four-digit access-code capacity
- » Latch mode
- » Wireless range up to 500 feet
- » Control up to 2 devices from 1 keypad
- » Connect up to 20 keypads to 1 transceiver
- » Personal master code
- » Limited-use code (1 to 9 uses)
- » "3 strikes, you're out" security
- » Variable relay time
- » Audible-tone feedback
- » Backlit keypad
- » Polycarbonate construction



((433 MHz))



Compatible with ALL Gate Operators Listed in this Catalog

ITEM #

GTSMX5151

Linear.

Stand Alone Commercial Entry Keypad



- » 12/24 Volt AC or DC
- » 480 codes
- » Lighted
- » Stainless steel face

Compatible with ALL Gate Operators Listed in this Catalog

ITEM #

GTA1050G

DESCRIPTION

Commercial Keypad

PEDESTALS / STAND



Access Control Pedestals

- » 2" Steel Square tubing with flanged faceplate
- » Black powder coated finish

Compatible with ALL Gate Operators Listed in this Catalog

ITEM #

GTAPEDFLG

DESCRIPTION

(Flange) 42"

GTAPED

(Bury) 64"



Operator Stand

- » High-quality welded construction
- » Galvanized Legs
- » 4" x 2" rectangular base
- » 3" x 3" galvanized legs

Compatible with
LiftMaster CSW 24 V on Page 242
Viking R6 on Page 243
LiftMaster RSL12VDC on Page 244
LiftMaster CSL24VDC on Page 244
Viking K-2 on Page 245
Eagle I on Page 245

ITEM #

GTASTAND

COMPATIBLE OPERATOR

Universal

EXIT BUTTON

Request-to-Exit Rocker Switch

Vandal Resistant

SECO-LARM

Available in Slimline or Single Gang



- » Stainless steel face-plate/push button
- » Exit /Salida silk-screened on plate
- » Fits into standard single-gang box
- » Equipped with 1 N.O. and 1 N.C. (DPST) switch rated 5A@250VAC
- » Weatherproof; indoor or outdoor use

Compatible with ALL Gate Operators Listed in this Catalog

ITEM #

GTAKRTEVP

DESCRIPTION

Single Gang Push to Exit

GTAKRTEVPMN

Slimline Push to Exit

TRANSFORMERS

Transformer/ Battery Charger



Great for Apollo
Gate Operator Batteries

- » Charges battery & safely maintains charge during inactivity
- » Protects against over-charge or short circuit
- » Fully automatic
- » Plugs into household 110 volt
- » 1.5 amp trickle charge

Compatible with
LiftMaster CSW 24 V on Page 242
NICE/Apollo 1500 12VDC on Page 242
NICE/Apollo Titan 12VDC on Page 243
LiftMaster CSL24VDC on Page 244

ITEM#

GTS404

Plug in Transformers



For Indoor Use,
Not Weather-Proof

- » With power indicator light

ITEM#

DESCRIPTION

GTA8801	12 VAC 40 VA
GTA8802	16.5 VAC 40 VA
GTA8803	18 VAC 40 VA
GTA8804	24 VAC 40 VA
GTA8806	12 VDC 500 mA
GTA8805	24 VDC 1000 mA
GTA8807	36 VDC 500 mA

MAGNETIC LOCKS

Weatherproof Magnetic Gate/Door Lock with Weld-On Brackets



Two Options:
600 lb or 1300 lb
of Holding Force

- » Includes weldable brackets for armatur and magnet
- » Designed for indoor or outdoor use

ITEM#

DESCRIPTION

GTEMG600	600 lb. Lock
GTEMG1300	1300 lb. Lock

Compatible with ALL Gate Operators
Listed in this Catalog

Automatic Gate Lock



3500 lb of
Holding Force



- » Black powder-coated steel housing
- » 12 Volt DC only
- » Recommended for gates over 8 ft
- » Bolt-on and weldable hardware included

Compatible with ALL Gate Operators
Listed in this Catalog

ITEM#

DESCRIPTION

GTGFM144P	Pull to Open Gate Lock
-----------	------------------------

FIRE DEPARTMENT EMERGENCY ENTRY BOXES

Manual Release Fire Box

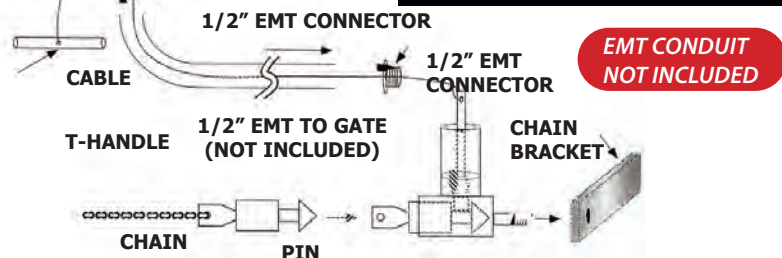
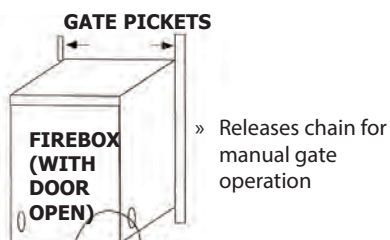

Manual Release Fire Box Works with Sliding Gates Only

ITEM #	DESCRIPTION
GTEACP17	Manual Release

The Microswitch and Knox Lock Box are Compatible with All Gate Operators

Knox Lock Box



- » Uses Knox style lock to activate Gate. (Knox lock not included)

ITEM#	DESCRIPTION
GTAFBK	Knox Style Fire Lock Box

Microswitch Box



- » Internal Microswitch opens gate when box door is opened
- » Box door held closed by Fire Dept. approved lock (Lock not included)

ITEM#	DESCRIPTION
GTAFBMS	Microswitch Fire Lock Box

Falcon Padlock



- » Fire department approved lock for City of Houston only
- » Keys not included.

ITEM #	DESCRIPTION
GTAFCN	Falcon Lock

Red Primed Steel Pipe

3/16" Wall

In Stock & Ready for Pickup or Shipping

4-1/2" OD x 7'
6-5/8" OD x 7'

Custom Lengths Available - Inquire with Sales



ITEM #	OD	LENGTH
P658188PTD7	6-5/8"	7 FT
P412188PTD7	4-1/2"	7 FT

BOLLARD SLEEVES

Smooth Bumper Post Sleeve

Make Old Bollard Posts Look Like New

- » 1/8" bollard cover fits 4" and 6"

High-Density Polyethylene Construction

Low Maintenance: UV Protection Aids in Preventing Fading, Rusting and Cracking Never Paint Again!

Easy Installation: Patented Installation Tape Provides a Quick, Secure Install within Minutes

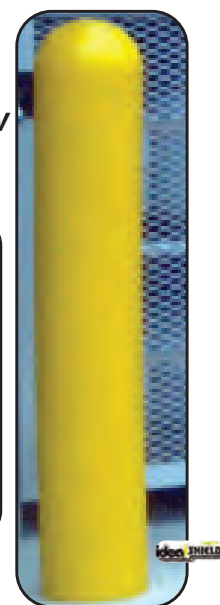

Available in 2 Sizes

ITEM #	DIAMETER	SLEEVE THICKNESS	HEIGHT	COLOR
CABSM184Y	4-1/2"	1/8"	57"	Yellow
CABSM186Y	6-5/8"	1/8"	57"	Yellow

ITEM NUMBER INDEX

AC1.....184	BHM.....22	CI355.....204	CI649BGR.....101	CI75RCS.....96	CI8821.....103
AC1000Y.....184	BHMADJ.....23	CI356.....204	CI649S.....101	CI75RCW.....96	CI8832.....102
AC10A.....185	BHS.....27	CI357.....204	CI649X.....101	CI76.....116	CI8832Y.....102
AC10A34.....185	BHXL.....22	CI358.....204	CI649ZXL.....101	CI7618.....202	CI8832Z.....102
AC118AL.....99	BHX.....27	CI385Q.....198	CI653.....114	CI78.....116	CI8858.....103
AC119AL.....99	CABSM184Y.....250	CI38X.....198	CI654.....98	CI79.....116	CI89.....200
AC12.....185	CABSM186Y.....250	CI38XL.....198	CI655.....104	CI7924.....112	CI900.....98
AC120AL.....99	CI1.....191	CI3A.....80	CI656.....102	CI7X.....105	CI9002.....98
AC136.....184	CI108.....106	CI3A.....98	CI65634.....102	CI7XL.....105	CI901.....98
AC14.....185	CI10A.....191	CI3B.....80	CI65634YS.....102	CI80.....192	CI902.....98
AC15.....184	CI10A34.....191	CI3HRB.....81	CI656XS.....102	CI8005.....102	CI907.....191
AC17.....186	CI10AF.....193	CI3HRB.....98	CI657.....110	CI8010.....104	CI9102.....206
AC18.....186	CI112.....106	CI400HL.....96	CI657M.....110	CI8015.....104	CI9102.....113
AC2.....184	CI114.....106	CI400HR.....96	CI657XS.....110	CI8020.....103	CI9103.....206
AC20.....186	CI114RS.....115	CI4010.....188	CI659.....103	CI8025.....101	CI9103.....113
AC21.....186	CI116.....105	CI401HL.....96	CI65912S.....104	CI8030.....110	CI9104N.....113
AC22.....185	CI117.....105	CI401HR.....96	CI65934S.....104	CI8035.....110	CI9105.....113
AC234.....184	CI118.....106	CI4020.....188	CI65F.....188	CI804.....78, 106	CI9106N.....113
AC23N.....187	CI119.....106	CI4030.....188	CI65X.....188	CI805.....78, 106	CI9113X.....206
AC270.....186	CI12.....191	CI4050.....188	CI66.....102	CI806.....78, 106	CI9115X.....206
AC3.....185	CI120.....106	CI4510.....193	CI660XS.....111	CI807.....78, 106	CI9116.....206
AC308.....187	CI121.....106	CI4520.....193	CI661.....104	CI808.....78, 106	CI9134.....199
AC31.....187	CI125.....106	CI4530.....193	CI6634.....102	CI809.....78, 106	CI9324.....101
AC4.....185	CI126.....106	CI4X.....96	CI667.....103	CI80A.....192	CI9345.....203
AC4X.....99	CI13.....203	CI4X112.....96	CI668.....103	CI80B.....188	CI9347.....203
AC4XW.....99	CI1345.....195	CI5.....97	CI669.....104	CI81.....116	CI9350.....205
AC584.....187	CI1348.....205	CI5005.....205	CI66XS.....102	CI810.....78, 106	CI9351L.....205
AC585.....187	CI1401.....105	CI5010.....196	CI671.....104	CI811.....78, 106	CI9351R.....205
AC5XL.....99	CI1402.....105	CI5015.....196	CI671XL.....104	CI8191.....206	CI9360.....203
AC5XLW.....99	CI1403.....105	CI5020.....197	CI675XL.....197	CI8192.....206	CI94.....198
AC605.....184	CI1404.....105	CI5025.....196	CI680.....205	CI8194.....206	CI9414.....199
AC64958AL.....99	CI14051.....81, 98	CI5030.....196	CI68310.....111	CI82.....116	CI9450.....200
AC649AL.....99	CI14052.....81, 98	CI5035.....196	CI683112XL.....111	CI820.....195	CI94A1.....81
AC649SAL.....99	CI14053.....81, 98	CI5055.....197	CI68312.....111	CI821.....195	CI94A3.....98
AC68312AL.....99	CI146.....191	CI5060.....196	CI68312BGR.....111	CI8212.....78, 106	CI94A4.....77
AC68334AL.....99	CI147.....191	CI5065.....196	CI68334.....111	CI823.....195	CI94A4A.....77
AC68358AL.....99	CI147XS.....191	CI5085.....205	CI68358.....111	CI83.....116	CI9534.....114
AC6XL.....99	CI14XL.....202	CI5090.....205	CI685V.....111	CI8304.....207	CI9536.....105
AC6XLW.....99	CI150.....198	CI5095.....204	CI686.....203	CI8306.....207	CI9537.....105
AC801.....187	CI150B.....198	CI5112.....97	CI690.....197	CI8325.....202	CI9538.....105
AC807AL.....99	CI1510.....189	CI515LLS.....96	CI691.....199	CI834.....110	CI9539.....105
AC808AL.....99	CI1520.....189	CI55LLW.....96	CI696.....196	CI8397.....113, 206	CI954.....104
AC809AL.....99	CI1530.....189	CI55RLS.....96	CI699.....202	CI8398.....113, 206	CI9540.....113
AC9.....185	CI1540.....189	CI55RLW.....96	CI7000X.....207	CI84.....109	CI9611.....203
AC9X34AL.....99	CI17.....193	CI6.....97	CI7005.....109	CI840YN.....104	CI9629.....198
AC9XAL.....99	CI18.....193	CI60.....188	CI7010.....109	CI850.....189	CI9634.....203
ACM11.....187	CI2.....191	CI6003.....207	CI7020.....109	CI8504.....199	CI9640.....207
ACM13.....187	CI20.....194	CI6008.....207	CI7025.....109	CI8507.....196	CI9640D.....207
ACRI312.....117	CI2010.....194	CI6009.....207	CI7027.....109	CI8521.....112	CI9681.....207
ACRI4.....117	CI21.....191	CI601334.....104	CI7030.....111	CI8523.....113	CI98.....189
BDDWMT181184.....227	CI212B.....111	CI6020.....190	CI7035.....112	CI8527.....112	CI98B.....189
BFL1478.....72	CI21834.....103	CI6025.....190	CI7040.....114	CI852XS.....189	CI98C.....189
BFT121.....72	CI21L.....194	CI6030.....190	CI7050.....114	CI853Y.....103	CI9935.....203
BFT12114.....72	CI22.....190	CI6040.....190	CI7053.....96	CI854.....189	CI9988.....201
BFT1234P.....72	CI23.....191	CI6050.....190	CI7055916.....114	CI856.....189	CI998P.....207
BFW101.....72	CI2341.....115	CI6059.....110	CI7058.....98	CI858.....189	CI999P.....207
BFW10112.....72	CI234112.....115	CI6065.....190	CI705G.....202	CI8609.....109	CI9A.....101
BFW9112.....72	CI2342.....115	CI6070.....190	CI7065.....102	CI864.....102	CI9C.....101
BH10.....27	CI23A.....194	CI6080.....190	CI7070.....110	CI86434.....102	CI9J.....104
BH11.....27	CI23F.....194	CI6090.....190	CI7075.....102	CI864X.....202	CI9R.....105
BH3.....27	CI24.....194	CI60X.....191	CI7080.....103	CI865.....101	CI9RS.....105
BH6.....27	CI2511.....114	CI6112.....97	CI7085.....103	CI8656.....202	CI9X.....101
BH7.....27	CI2520.....194	CI617.....202	CI7090.....103	CI8657.....201	CI9X34.....101
BHG11.....27	CI26.....194	CI623.....200	CI7095.....103	CI8658.....201	CI9X58.....101
BHG5.....27	CI27A.....194	CI6317.....197	CI7215.....204	CI8660F.....203	CI9XL114.....101
BHG7.....27	CI3.....190	CI6357.....198	CI7217.....204	CI8661.....189	CI9Y.....101
BHG9.....23	CI3010.....204	CI641XLF.....191	CI726.....202	CI88.....199	CI9Z.....101
BHL.....22	CI306.....200	CI646.....200	CI73.....116	CI8802.....103	CICC.....114
BHLADJ.....23	CI3510.....192	CI648.....197	CI7462.....200	CI880234.....103	CICD880112.....116
	CI3520.....192	CI649.....101	CI7463.....200	CI880258.....103	CICD8802.....116
	CI3530.....192	CI64934.....101	CI75LCS.....96	CI8804.....101	CIDD.....114
	CI3540.....205	CI64958.....101	CI75LCW.....96	CI8805FB.....102	CIDD34.....113
					CI9E.....114
					CI9E58.....114
					CI9H.....114
					CI9RSEHD2.....105
					CI9RSEHD4.....105
					CI9K2.....113
					CI9L411.....195
					CI9L423.....195
					CI9L424.....195
					CI9L.....114
					CI9M.....114
					CI9R.....114
					CI9S.....114
					EG1065D.....87
					EG1070D.....87
					EG1075D.....87
					EG1085D.....87
					EG1265D.....87
					EG1275D.....87
					EG1465D.....87
					EG1670D.....87
					EG36D.....87
					EG4655.....87
					EG7705.....87
					EL11245.....83
					EL11290.....83
					EL11290S.....83
					EL11445.....83
					EL11490R.....83
					EL11490S.....83
					EL1245.....83
					EL1290.....83
					EL21245.....83
					EL21290.....83
					EL245.....83
					EL290.....83
					EL3445.....83
					EL345.....83
					EL3490.....83
					EL390.....83
					EL445.....83
					EL490.....83
					EL645.....83
					EL690.....83
					ELCAP1.....83
					ELCAP112.....83
					ELCAP114.....83
					ELCAP2.....83
					ELCAP212.....83
					ELCAP3.....83
					ELCAP4.....83
					ELCAP5.....83
					ELCAP6.....83
					ELTE1.....83
					ELTE112.....83
					ELTE114.....83
					ELTE2.....83
					ELTE212.....83
					ELTE3.....83
					ELTE4.....83
					ELTE6.....83
					ER001.....48
					ER005.....48
					ER2012.....48
					ER2678.....48
					ER400.....48
					ER400L.....48
					ER4800.....57
					FC101.....87
					FC106.....87

FC525.....87	FW63179.....8	GANVEXT26094.....13	GTA8803.....249	HA19CB.....44	HA558.....24	HAC350XL.....69
FRF3416.....2	FW63200.....9	GANVEXT34848.....13, 17	GTA8804.....249	HA2.....24	HA558M.....24	HAC36.....64
FRF48.....2	FW63202.....9	GANVEXT34894.....13	GTA8805.....249	HA20.....62	HA55R.....62	HAC3WCPR.....63
FRF5216.....2	FW63219.....8	GANVEXT36048.....13, 17	GTA8806.....249	HA21.....61	HA56C.....62	HAC440.....29
FRF58.....2	FW63221.....8	GANVEXT36094.....13	GTA8807.....249	HA212RR.....59	HA57.....40	HAC490.....64
FRZ112G.....4	FW63286.....11	GANVEXT37248.....13, 17	GTACP4.....246	HA212SR.....59	HA58.....62	HAC500A.....20
FRZ1G.....4	FW63287.....11	GANVEXT37294.....13	GTADTM12.....247	HA21B.....61	HA5M.....24	HAC640.....38
FRZ2G.....4	FW63288.....11	GANVFT24848.....12, 17	GTADTM24.....247	HA21TR4.....61	HA5WTF.....24	HAC650.....38
FRZ3G.....4	FW63289.....11	GANVFT24894.....12	GTAFBK.....250	HA22.....61	HA5WTFM.....24	HAC673.....38
FW10558.....7	FW63659.....10	GANVFT26094.....12	GTAFBMS.....250	HA22B.....61	HA6.....40	HAC737150.....40
FW12000.....6	FW63671.....11	GANVFT34848.....12, 17	GTAFCN.....250	HA23.....40	HA6PR.....59	HAC745.....40
FW12002.....6	FW63676.....11	GANVFT34848ARC.12, 16	GTAKRTEVP.....248	HA234.....24	HA6PS.....59	HAC86G.....28
FW12008.....6	FW63677.....11	GANVFT34894.....12	GTAKRTEVPMN.....248	HA24.....40	HA6PSB.....59	HAC87G.....28
FW12009.....6	FW63687.....10	GANVFT36048.....12, 17	GTAL48.....247	HA24CB.....44	HA6RR.....59	HAC8C.....64
FW12010.....6	FW63756.....6	GANVFT36094.....12	GTAL812.....247	HA25.....38	HA65R.....59	HAC90G.....29
FW12011.....6	FW63763.....6	GANVFT37248.....12, 17	GTANP2ESL.....247	HA258.....24	HA65SRH.....59	HAD10.....66
FW12012.....7	FW63766.....11	GANVFT37248ARC.12, 16	GTANR10K.....246	HA25812.....24	HA65S.....59	HAD100.....66
FW12014.....7	FW63773.....11	GANVFT37294.....12	GTANRP.....246	HA258ADJ.....22	HA7.....36	HAD110.....66
FW12020.....7	FW63782.....11	GANVFTFB34848.....17	GTAOMRON.....246	HA258LG.....24	HA700.....37	HAD140.....66
FW12022.....7	FW63868.....6	GANVFTFB34894.....14	GTAPED.....248	HA26.....38	HA701.....37	HAD150.....66-67
FW12023.....7	FW63946.....7	GANVFTFB36048.....17	GTAPEDFLG.....248	HA27.....59	HA704.....40	HAD160.....66-67
FW12052.....6	FW63954.....7	GANVFTFB36094.....14	GTASTAND.....248	HA29.....59	HA74001315.....33	HAD200.....36
FW12061.....6	FW64874.....6	GANVFTFB37248.....17	GTAW14.....247	HA2LG.....24	HA74108315.....33	HAD200PRD.....66
FW12212.....6	FW64882.....6	GANVFTFB37294.....14	GTDECL230DPH.....57	HA2RM.....59	HA74108325.....33	HADC.....36
FW12213.....7	FW64883.....6	GANVFTPP336048.....14	GTACP17.....250	HA25M.....59	HA77W.....36	HAGH12320.....44
FW12216.....7	FW78766.....7, 10-11	GANVFTPP34848.....14, 17	GTECSL24UL.....244	HA301.....65	HA8.....40	HAJ100.....25
FW12410.....7	FW78767.....11	GANVFTPP34894.....14	GTECSW24VDC.....242	HA30112.....65	HA81.....41	HAJ105.....25
FW12412.....7	FW78768.....7, 11	GANVFTPP36048.....17	GTELA400PKGDC.....240	HA301B.....65	HA82.....41	HAJ110.....25
FW12514.....7	FW78769.....11	GANVFTPP36094.....14	GTELA412PKGDC.....240	HA301B12.....65	HA83.....41	HAJ115.....25
FW12515.....7	FW78770.....7	GANVFTPP37248.....14, 17	GTELA500PKGDC.....241	HA301B22.....65	HA84.....41	HAJ120.....25
FW12518.....7	GA719421204.....19	GANVFTPP37294.....14	GTELMRRU.....246	HA301B40.....65	HA85.....41	HAJ130.....25
FW12743.....7	GA729421204.....19	GANVFTTB34848.....14	GTELOOPDETLM.....247	HA301B50.....65	HA9M1.....43	HAJ140.....25
FW12744.....6	GAA1121214C.....86	GANVFTTB36048.....14	GTEMG1300.....249	HA301RP.....65	HA9M2.....43	HAJ150.....25
FW12805.....6	GAA1121214S.....86	GANVFTTB37248.....14	GTEMG600.....249	HA302.....65	HA9M3.....42	HAJ200.....40
FW12816.....6	GAA1121221S.....86	GANVSP34848.....15, 16	GTERSL12UL.....244	HA303W.....65	HA9M4.....42	HAJ210.....41
FW12817.....7, 9	GAA1121614C.....86	GANVSP34894.....15	GTERSW12VDC.....241	HA306H.....65	HA9MAT1.....43	HAJ220.....41
FW12818.....6	GAA1121614S.....86	GANVSP36048.....15-16	GTGFM144.....249	HA31.....62	HA9MAT2.....43	HAJ230.....41
FW12819.....6	GAA1121621S.....86	GANVSP36094.....15	GTM19RBA.....57	HA32.....62	HA9S.....36	HAJ240.....41
FW12855.....7	GAA112814C.....86	GANVSP37248.....15-16	GTMAG9005.....54	HA33.....62	HAC100.....60	HAJ250.....41
FW12856.....7	GAA112814S.....86	GANVSP37294.....15	GTMAGMAG9005.....54	HA33L.....62	HAC11201R.....67	HAJ300.....44
FW12873.....7	GAA112821S.....86	GE3FP.....18	GTMF18RBAL.....57	HA34.....63	HAC11241SQ.....67	HAJ350.....44
FW12876.....7	GAA21214C.....86	GEND4.....18	GTS1500.....242	HA345M.....67	HAC130621.....67	HAJ51.....25
FW12879.....7	GAA21214S.....86	GEND5.....18	GTS201.....247	HA35.....63	HAC135M18.....28	HAJ52.....25
FW12882.....7	GAA21221S.....86	GEND6.....18	GTS208.....247	HA35XBLK.....63, 69	HAC150M18.....28	HAJ53.....25
FW12896.....7	GAA21614C.....86	GEND7.....18	GTS210.....247	HA35XWHT.....63, 69	HAC163.....28	HAJ54.....25
FW12937.....7	GAA21614S.....86	GHARCH40.....86	GTS220.....247	HA36.....63	HAC17812.....28	HAJ55.....25
FW12987.....7	GAA21621S.....86	GP212166.....18	GTS22024.....247	HA37RT.....63	HAC17824.....28	HAJ65.....41
FW12992.....7	GAA2814C.....86	GP212167.....18	GTS240.....247	HA37RT.....234	HAC200G.....63	HAKF3ABL.....32
FW12993.....7, 9	GAA2814S.....86	GP212168.....18	GTS24024.....247	HA38.....63	HAC2120.....63	HAKF3L2BL.....32
FW21803.....7	GAA2821S.....86	GP212169.....18	GTS24BK.....247	HA3RM.....59	HAC24.....64	HALB124BKKS.....44
FW25358.....7	GANV1.....19	GP21611.....18	GTS404.....249	HA3RR.....59	HAC243D25.....63	HALBBPBG.....44
FW61535.....6	GANV2.....19	GP2164.....18	GTSMOFB.....246	HA3SM.....59	HAC243D40.....63	HALLMBT.....43
FW61538.....6	GANV3.....19	GP2164FLG.....18	GTSMX5151.....248	HA3SR.....59	HAC293.....60	HALTB200.....35
FW61994.....6	GANVC1.....19	GP2165FLG.....18	GTS510L24V.....247	HA4.....40	HAC2C.....64	HALTB200SS.....35
FW62636.....11	GANVC2.....19	GP2166.....18	GTSTKAC1.....243	HA40.....61	HAC300D50.....60	HALTB400.....35
FW62637.....10	GANVC3.....19	GP2166FLG.....18	GTSTKS1.....243	HA41.....61	HAC3019MT.....67	HALTB400SS.....35
FW62638.....11	GANVCCUR39490.....15	GP2167.....18	GTVAK2NX.....245	HA4PR.....59	HAC304M102Q.....69	HAMLKEY.....43
FW62668.....10	GANVCEXT35890.....13	GP2168.....18	GTVAR6NX.....243	HA4PS.....59	HAC305V100.....60	HAMLLDAB.....42
FW62679.....11	GANVCEXT37048.....13, 16	GP2169.....18	GTZ1RES.....245	HA4PSB.....59	HAC305V140.....60	HAMLLP1S.....42
FW62681.....10	GANVCEXT37090.....13	GP31410.....18	GTZEG360.....246	HA4RM.....59	HAC326V100.....60	HAMLLP2S.....42
FW62682.....10	GANVCEXT39490.....13	GP3148.....18	HA1.....40	HA4RR.....59	HAC333D100.....60	HAMLSP.....43
FW62683.....10	GANVCFT3.....12	GP41110.....7, 18	HA10.....40	HA4SM.....59	HAC345M.....67, 69	HAP115903.....39
FW62686.....11	GANVCFT34648.....16	GPSC212GB.....19	HA106.....40	HA4SR.....59	HAC345P.....69	HAP1181A.....39
FW62687.....10	GANVCFT34690.....12	GPSC2GB.....19	HA109.....41	HA4SRH.....59	HAC345XL.....69	HAP1184Z.....39
FW62737.....11	GANVCFT35890.....12	GPSC3GB.....19	HA12.....44	HA4SS.....59	HAC346M.....69	HAP1186L.....39
FW62739.....11	GANVCFT37090.....12	GPSC4GB.....19	HA12S.....36	HA4WH.....40	HAC346P.....69	HAP1186R.....39
FW62740.....11	GANVCSP37048.....15-16	GTA1050G.....248	HA13.....36	HA4WHPC.....40	HAC346XL.....69	HAP118Z03.....39
FW62741.....11	GANVCSP37090.....15	GTA1301.....57	HA14.....44	HA5.....24	HAC347M.....69	HAP1194.....39
FW62991.....6	GANVCSP39490.....15	GTA1955.....57	HA16.....63	HA51.....62	HAC347P.....69	HAP1260Z.....39
FW62996.....11	GANVEXT24848.....13, 17	GTA4032.....57	HA16HD.....63	HA52.....62	HAC347XL.....69	HAP2745S.....38
FW63167.....11	GANVEXT24894.....13	GTA8801.....249	HA18.....44	HA54RD.....62	HAC350M.....69	HAP2883.....38
FW63177.....8	GANVEXT26048.....13	GTA8802.....249	HA19.....63	HA54SQ.....62	HAC350P.....69	HAP2884.....38

HAP2902.....37	HIPS27216.....30	HT151545.....230	KW665514.....46	MC1SSHD.....234	MCPR45Q.....239	MIT045.....209
HAP2965Z.....38	HIS2.....26	HT151606.....230	KW6655A.....46	MC1T.....234	MCPR46.....238	MITM023.....209
HAP601.....37	HIS2153.....29	HT151693.....232	KW720C514.....47	MCBBQ1.....234	MCPR461G.....238	MITM030.....209
HAP8645.....37	HIS3.....26	HT152506.....228	KW720H15.....47	MCC126BLK.....107	MCPR47.....238	MITM035.....209
HAP866ZN.....37	HIS4.....26	HT152507.....228	KW720H514.....47	MCC128BLK.....107	MCPR471G.....238	MPM000069.....209
HAP870.....37	HIT1.....32	HT152822.....220	KW720HF.....47	MCC16.....107	MCPR48.....238	OW14112.....73
HAQB124.....44	HIT2.....32	HT1MH.....229	KW78515.....46	MCC16BLK.....107	MCPR481G.....238	OW142.....73
HAQB140.....44	HITCA1.....32	HT200.....231	KW78526.....46	MCC166GLV.....107	MCPR49.....239	OW14212.....73
HAR89BK103.....71	HITCA1L2.....32	HT215.....231	KW962.....36	MCC18.....107	MCPR491G.....239	OW143.....73
HAR89BK79.....71	HITCA2.....32	HT218.....231	KW980514.....46	MCC18BLK.....107	MCPR50.....238	OW5162.....73
HAR89BRZ103.....71	HITCA2L2.....32	HT225102.....229	KW985514.....46	MCC18GLV.....107	MCPR501G.....238	OW5163.....73
HAR89BRZ79.....71	HITCACAPS3.....32	HT225103.....229	LB1000.....52	MCC346.....107	MCPR51.....239	P412188PTD7.....250
HAR89SN103.....71	HITCAMA2RND.....33	HT225106.....229	LB1000EE.....52	MCC346BLK.....107	MCPR511G.....239	P658188PTD7.....250
HAR89SN79.....71	HITCGS1.....63	HT225108.....229	LB123.....45	MCC346GLV.....107	MCPR52.....238	PA10231.....226
HAR89ST5103.....70	HITCGS2.....63	HT241.....236	LB218.....45	MCC348.....107	MCPR521G.....238	PA10232.....226
HAR89ST579.....70	HITCGS3.....63	HT25MAG.....230	LB218234.....45	MCC348ARC.....107	MCPS1PM.....235	PA17104.....49
HAR91410072.....70	HITCHDCAPS3.....32	HT2MH.....229	LB218D.....45	MCC348BLK.....107	MCPSPB1.....235	PA314018.....226
HAR91410096.....70	HITCHDRND1.....33	HT30DEW.....230	LB218DT.....45	MCC348BLKARC.....107	MCPSPB2.....235	PA322013.....226
HAR9146072.....70	HITCHDRND2.....33	HT4004.....230	LB218DXW.....45	MCC348GLV.....107	MCPSPB3.....235	PA322016.....226
HAR9146096.....70	HIW112F.....24	HT4006.....230	LB218T.....45	MCC348GLVARC.....107	MCPSPB4.....235	PA322017.....226
HAR9147072.....70	HIW212M.....24	HT4008.....230	LB218XW.....45	MCLBDG4060.....50	MCPPW32.....235	PA322019.....226
HAR9147096.....70	HIW2F.....24	HT4240DCW.....233	LB2835.....53	MCLBDG54060L.....50	MCPPW32R.....235	PA322022.....226
HASAM1.....35	HIW2M.....24	HT666012.....231	LB900.....52	MCLBDG54060R.....50	MCPPW39.....235	PA322023.....226
HATA3.....64	HIW3M.....24	HT666062.....231	LB9200L.....45	MCLBL19.....46	MCPWP5.....235	PA322024.....226
HATA5.....64	HL141.....73	HT6820.....230	LB9200R.....45	MCLBL20.....46	MCPWPB1.....235	PA322026.....226
HAU101.....39	HL14112.....73	HT6830.....230	LBAC218DT.....45	MCLBLD40605.....51	MCPWPB2.....235	PA322032.....226
HB145.....208	HL142.....73	HT71665.....227	LBAC218T.....45	MCLBSK.....51	MCPWPB3.....235	PA322033.....226
HB1601.....208	HL143.....73	HT725.....230	LBES.....48	MCLEM100.....49	MCPWPB4.....235	PA322042.....226
HB770860.....214	HL382.....73	HT730.....230	LK3018LA.....55	MCLEM200.....49	MCR1.....96-97	PA322043.....226
HB770866.....214	HL383.....73	HT740.....230	LK3019LA.....55	MCLEM300L.....49	MCR1.....96-97	PA322047.....226
HI100.....26	HL384.....73	HT750122.....220	LK6403.....55	MCLEM300R.....49	MCR112.....96-97	PA322048.....226
HI1250.....34	HL5002.....73	HT775.....211	LK7015100.....55	MCLGMW23AC.....49	MCR112AL20.....99	PA322054.....226
HI25.....26	HL5003.....73	HT8209.....239	LK701540.....55	MCLH123.....49	MCR1AL20.....99	PA326005.....226
HI3000.....31	HL5161.....73	HT8211.....239	LK701550.....55	MCLHL100.....49	MCRMTH1420.....98	PA326006.....226
HI3125.....26	HL5162.....73	HT8212.....239	LK701580.....55	MCLL2210.....53	MCSA50.....233	PA326008.....226
HI312WH.....26	HL5163.....73	HTMC1L.....233	LKCARACAL.....34	MCLL2210DS.....53	MCSAFSF.....18	PA326010.....226
HI3300.....31	HL5164.....73	HTMFT10.....229	LKCLH.....56	MCLL238.....53	MCSAFSF.....233	PA326011.....226
HI3400.....31	HL903.....73	HTMW3.....231	LKDRILLFIX.....56	MCLL2835.....53	MCTR300.....90	PA326012.....226
HI3700.....31	HL905.....73	HTPA634.....228	LKFORTIMA.....42	MCLL2835BK.....53	MCTR400.....90	PA326014.....226
HI3720.....31	HL908.....73	HTPL634.....228	LKIKIT6OBL.....56	MCLL2835DS.....53	MCTR500.....90	PA326015.....226
HI3850.....34	HLAT1210.....73	HTUF65C3.....229	LKLAQ30UBL.....54	MCLL2835DSBK.....53	MCTR600.....90	PA326016.....226
HI3H.....26	HLAT123.....73	HTUG125C3.....229	LKLAQ30USL.....54	MCLL2950.....53	MCTR700.....90	PA326020.....226
HI35.....26	HLAT126.....73	HTWAC324.....229	LKLAQ40UBL.....54	MCLL2950BK.....53	MCTW312.....233	PA357020.....226
HI4H.....26	HLAT12N.....73	KW15915.....46	LKLAQ40USL.....54	MCLL2950DC.....53	MI087067.....209	PA39908.....224
HI45.....26	HLAT12W.....73	KW159514.....46	LKLAKY20FBL.....54	MCLL2950DCBK.....53	MI087068.....209	PA39909.....224
HISH.....26	HLAT3410.....73	KW200B15.....47	LKLAKY30FBL.....54	MCLLAAB.....53	MI087299.....209	PA39932.....224
HIGH.....26	HLAT343.....73	KW200B514.....47	LKLAKY40FBL.....54	MCLLBG210L.....53	MI169715.....209	PA39933.....224
HI6JL.....29	HLAT346.....73	KW200C15.....47	LKLAKY50FBL.....54	MCLLBG950.....53	MI169716.....209	PA39948.....224
HI6JR.....29	HLAT34N.....73	KW200C514.....47	LKLAPY10FBL.....54	MCLLPSSAF.....58	MI169724.....209	PA39949.....224
HI775.....24	HLAT34W.....73	KW200D26D.....47	LKLFKQ30XBL.....55	MCLLPSSSEC.....58	MI169725.....209	PA412FD36.....223
HIA212.....26	HLAT3810.....73	KW200D3.....47	LKLFKQ40XBL.....55	MCLLPSSK.....58	MI169726.....209	PA412FD40.....223
HIA4.....26	HLAT383.....73	KW200L15.....47	LKLMKQ30VBL.....55	MCLU1011.....52	MI169728.....209	PA412FD60.....223
HIC372.....30	HLAT386.....73	KW200L3.....47	LKLMKQ30VSL.....55	MCLU1011EE.....52	MI186406.....209	PA45001.....222
HIC430100L.....29	HLAT38N.....73	KW200L5A.....47	LKLMKQ40VBL.....55	MCLU1011L.....52	MI186419.....209	PA45005.....222
HIC430100R.....29	HLAT38W.....73	KW200P15.....47	LKLSKZ50UBL.....55	MCLU1011R.....52	MI206187.....209	PA45008.....222
HIC472.....30	HLAT5810.....73	KW200P5A.....47	LKLSKZ50USL.....55	MCLU900.....52	MI206189.....209	PA48899205.....226
HIC4904.....27	HLAT583.....73	KW200T26D.....47	LKLUKY4040.....54	MCLULP1010L.....52, 58	MI219515.....208	PA59204.....223
HIC4908.....27	HLAT583.....234	KW200T3.....47	LKM2.....34	MCLULP1010R.....52, 58	MI219516.....208	PA67508.....226
HIC4914.....27	HLAT586.....73	KW200T5A.....47	LKPB1.....57	MCLXL14S32D.....48	MI231410.....213, 215	PA67512.....226
HIC5555.....27	HLAT58N.....73	KW400T3.....47	LKQF2.....56	MCP100.....236	MI231411.....213	PA67516.....226
HIC6655.....27	HLAT58N.....234	KW400T5.....47	LKSAKLQFAL.....55	MCP200.....236	MI231921.....213	PA67520.....226
HIC72.....30	HLAT58W.....73	KW462KN26D.....48	LKSAKLQFBL.....55	MCP455115.....235	MI235628.....213, 215	PA67524.....226
HIGH604DA.....34	HLAT58W.....234	KW5883.....48	LKSEE.....56	MCPC13030.....236	MI245818.....213, 215	PA67832.....226
HIGHMLLH.....42	HLATAB12.....74	KW58926D.....48	LKSERVAL.....34	MCPR40.....239	MI246372.....209	PA892740.....226
HIH.....30	HLATAB12HD.....74	KW5893.....48	LKSHKLOFAL.....55	MCPR401G.....239	MI770237.....213	PA892742.....226
HIM3L.....30	HLATAB34.....74	KW66015.....46	LKSHKLOFBL.....55	MCPR41.....238	MI770246.....213	PA892744.....226
HIM3R.....30	HLATAB34HD.....74	KW6603.....46	LKSSKZ.....55	MCPR411G.....238	MI907627.....208	PA892746.....226
HIP27216.....30	HLATB12.....74	KW6605A.....46	LKT9005.....234	MCPR42.....239	MI907709.....208	PA892748.....226
HIP3180.....30	HLATB34.....74	KW66515.....46	LKV2.....35	MCPR421G.....239	MCWJ.....221	PA892750.....226
HIP372H.....30	HLATB58.....74	KW66515A.....46	LKV2WALL.....35	MCPR43.....238	MINM1200C.....209	PA892752.....226
HIP472H.....30	HT100.....225	KW66526D.....46	MA40.....38	MCPR431G.....238	MINSM1200C.....209	PA892754.....226
HIPAL27216.....30	HT150380.....213	KW6653.....46	MA800.....38	MCPR45.....239	MIT035.....209	PA892756.....226

PA93551.....	73	PB1016.....	72	PP71.....	78	PSM34.....	100	RA7432.....	75	SC8RP.....	83	SF1145.....	97
PABD41112.....	225	PB11.....	72	PP7112.....	78	PSM34W.....	79	RA7434.....	75	SCAL8103.....	80	SF1148.....	97
PABD41113.....	225	PB14.....	73	PP7B14.....	78	PSM34W.....	100	RA7436.....	75	SCAL8103.....	99	SF1149.....	97
PABD41118.....	225	PB1414.....	72	PP7B14.....	78	PSM40.....	100	RA7438.....	75	SCH.....	82-83	SF11491.....	168
PABD412C.....	222	PB1414.....	72	PP7B38.....	78	PSM50.....	100	SC101H.....	124	SCWL112.....	82	SF11492.....	168
PABD412H.....	222	PB14H.....	73	PPD210.....	79	PSM656.....	100	SC112.....	78, 106	SCWL114.....	82	SF11495.....	168
PABD57624.....	225	PB14HD.....	73	PPD210.....	19	RA10161.....	72	SC112A.....	78	SF10111.....	140	SF11496.....	168
PABL10.....	222	PB516.....	73	PPD222.....	79	RA1016112.....	72	SC112DOC.....	83	SF10113.....	140	SF11497.....	173
PABL12.....	222	PBC1004.....	85	PPPB12.....	78	RA101634.....	72	SC112F.....	82	SF10121.....	140	SF114A3.....	97
PABL14.....	222	PBC100412.....	85	PPRC1020.....	79	RA1051.....	73	SC112FSQ.....	82	SF10132.....	140	SF114B13.....	97
PABL4.....	222	PBC1005.....	85	PPRC15301.....	79	RA1055.....	73	SC112FT.....	78, 106	SF10142.....	140	SF114B14.....	97
PABL412.....	222	PBC1006.....	85	PPRC20301.....	79	RA1101.....	73	SC112RP.....	83	SF10174.....	140	SF114B4.....	97
PABL412CH.....	222	PBC1120412.....	85	PPRC20401.....	79	RA1105.....	73	SC114.....	78, 106	SF1032.....	158	SF114B5.....	97
PABL5.....	222	PBC1120434.....	85	PPRT10.....	79	RA1151.....	73	SC1144H.....	82	SF10381.....	143	SF114B8.....	97
PABL7.....	222	PBC1120512.....	85	PPRT12.....	79	RA1155.....	73	SC114A.....	78	SF10382.....	143	SF1151.....	97
PABL7C.....	222	PBC1120558.....	85	PPRT16.....	79	RA14141.....	72	SC114DOC.....	83	SF10431.....	136	SF1152.....	97
PABLCH7.....	222	PBC1120612.....	85	PPRT6.....	79	RA14141.....	72	SC114F.....	82	SF10432.....	136	SF1153.....	97
PACG44822.....	223	PBC1120634.....	85	PPRT8.....	79	RA1414112.....	18	SC114RP.....	83	SF10462.....	136	SF1154.....	97
PACG44824.....	223	PBC11234412.....	85	PPSQ10.....	79	RA14141BLK.....	72	SC13152.....	82	SF10462.....	136	SF11575.....	170
PACG44825.....	223	PBC1123441212.....	85	PPSQ12.....	79	RA14141BLK.....	18	SC138AL.....	78, 83	SF10463.....	132	SF11591.....	171
PACG44826.....	223	PBC1123441258.....	85	PPSQ201.....	79	RA2724.....	75	SC158AL.....	78, 83	SF10464.....	131	SF11592.....	171
PACG59506.....	223	PBC11234434.....	85	PPSQ201.....	19	RA2728.....	75	SC165102.....	83	SF10465.....	132	SF11595.....	171
PACG59507.....	223	PBC1123443434.....	85	PPSQ4.....	79	RA2732.....	75	SC165114.....	83	SF10466.....	130	SF11596.....	171
PACG59508.....	223	PBC11234512.....	85	PPSQ58.....	79	RA2764.....	75	SC16589.....	83	SF10491.....	148	SF11597.....	171
PACG59509.....	223	PBC11234558.....	85	PPSQ58.....	19	RA2768.....	75	SC166C.....	82	SF10502.....	148	SF11598.....	171
PACG59537.....	223	PBC11234612.....	85	PPSQ6.....	79	RA2772.....	75	SC166FC.....	83	SF10503.....	148	SF11610.....	97
PACG59540.....	223	PBC11234634.....	85	PPSQ6.....	19	RA2776.....	75	SC166S.....	82	SF1051.....	167	SF11613.....	97
PACG59543.....	223	PBC11241212.....	85	PPSQ6241.....	79	RA2808.....	74	SC178AL.....	78, 83	SF10512.....	148	SF11625.....	97
PACG59734.....	223	PBC11241258.....	85	PPSQ6241.....	19	RA2814.....	74	SC190C.....	82	SF10513.....	148	SF11626.....	97
PADW4714.....	222	PBC11243434.....	85	PPSQ8.....	79	RA2820.....	74	SC190FC.....	83	SF10514.....	148	SF11629.....	97
PADW8500.....	222	PBC2118434.....	85	PS00112.....	115	RA2826.....	74	SC190S.....	82	SF10515.....	148	SF116312.....	118
PAS20061.....	224	PBC2118458.....	85	PS00166.....	115	RA3762.....	75	SC1930.....	80	SF1052.....	167	SF11633.....	118
PAS20062.....	224	PBC211851.....	85	PS00190.....	115	RA3764.....	75	SC1938.....	80	SF1053.....	167	SF11635.....	119
PAS20086.....	224	PBC2118534.....	85	PS0031.....	115	RA3768.....	75	SC1C.....	76	SF10531.....	170	SF11671.....	162
PAS20087.....	224	PBC2118558.....	85	PS003112.....	115	RA5005.....	75	SC2.....	78, 106	SF1054.....	167	SF11672.....	162
PAS20088.....	224	PBC211861.....	85	PS003114.....	115	RA5010.....	75	SC212.....	78, 106	SF1054L.....	170	SF1169.....	97
PAS20163.....	224	PBC2118634.....	85	PS004112.....	115	RA5015.....	75	SC212FT.....	78, 106	SF10561.....	146	SF116A3.....	119
PAS20173.....	224	PBCR1000.....	84	PS0042.....	115	RA5020.....	75	SC212GAL.....	78	SF10713.....	160	SF116A4.....	119
PAS22011.....	224	PBCR1004.....	84	PS10A.....	100	RA5025.....	75	SC212RP.....	83	SF10715.....	160	SF116A5.....	119
PAS22021.....	224	PBCR100412.....	84	PS118B.....	100	RA5030.....	75	SC2375F.....	82	SF10841.....	146	SF116D1.....	135
PAS22053.....	224	PBCR1005.....	84	PS2.....	100	RA5034.....	75	SC238AL.....	78, 83	SF108A1.....	169	SF116D3.....	136
PAS22071.....	224	PBCR1006.....	84	PS3.....	100	RA5035.....	75	SC250.....	82	SF108A2.....	169	SF116E2.....	135
PAS23234.....	224	PBCR1120000.....	84	PS612.....	115	RA5040.....	75	SC2A.....	78	SF10911.....	161	SF116E4.....	135
PAS24011.....	224	PBCR1120412.....	84	PS658.....	115	RA5045.....	75	SC2FSQ.....	82	SF10912.....	161	SF116E6.....	148
PAS24039.....	224	PBCR1120434.....	84	PS807B.....	78	RA5050.....	75	SC2FT.....	78, 106	SF1093.....	169	SF116F1.....	118
PAS27403.....	225	PBCR1120512.....	84	PS807B.....	19	RA5055.....	75	SC2GAL.....	78	SF1103.....	169	SF116F10.....	118
PAWS412AFD40.....	223	PBCR1120534.....	84	PS807B.....	100	RA5060.....	75	SC2RP.....	83	SF11111.....	160	SF116F2.....	118
PAWS412AFD60.....	223	PBCR1120612.....	84	PS807W.....	78	RA7214.....	74	SC3.....	78, 106	SF11112.....	160	SF116F3.....	118
PAWS412PAD.....	223	PBCR1120634.....	84	PS807W.....	100	RA7215.....	74	SC312GAL.....	78	SF11211.....	172	SF116F4.....	118
PAWS412SD24.....	223	PBCR2000.....	84	PS808B.....	78	RA7216.....	74	SC312RP.....	83	SF1123.....	172	SF116F5.....	118
PAWS412SD36.....	223	PBCR2118434.....	84	PS808B.....	19	RA7217.....	74	SC34P.....	78	SF1125.....	172	SF116F6.....	118
PAWS412SD60.....	223	PBCR2118534.....	84	PS808B.....	100	RA7218.....	74	SC35B.....	80	SF1127.....	172	SF116F8.....	118
PAWS4AFD40.....	223	PBCR2118634.....	84	PS808W.....	78	RA7219.....	74	SC35B.....	98	SF1129.....	172	SF11701.....	158
PAWS4AFD60.....	223	PBT40.....	73	PS808W.....	100	RA7227.....	74	SC35BRP.....	80	SF112B9.....	173	SF11711.....	158
PAWS4CR.....	224	PMP522116.....	2	PSM25.....	19	RA7320.....	74	SC35BRP.....	98	SF1131.....	173	SF11712.....	158
PAWS4SD24.....	223	PMP522332.....	2	PSM25.....	100	RA7322.....	74	SC3A.....	78	SF11310.....	110	SF1172.....	118
PAWS4SD36.....	223	PP111.....	79	PSM2534.....	19	RA7323.....	74	SC3FT.....	78, 106	SF1132.....	173	SF1174.....	118
PAWS4SD60.....	223	PP11211.....	79	PSM2534.....	100	RA7355.....	74	SC3GAL.....	78	SF1133.....	173	SF1176.....	118
PAWS7AFD40.....	223	PP11216.....	79	PSM2534W.....	100	RA7360.....	74	SC3RP.....	83	SF1134.....	173	SF1177.....	118
PAWS7AFD60.....	223	PP11411.....	79	PSM2558.....	19	RA7400.....	75	SC4.....	78, 106	SF1135.....	172	SF1178.....	118
PAWS7NA.....	222	PP11416.....	79	PSM2558.....	100	RA7402.....	75	SC4A.....	78	SF11353.....	157	SF1179.....	118
PAWS7PAD.....	223	PP116.....	79	PSM25W.....	100	RA7404.....	75	SC4FT.....	78, 106	SF11354.....	157	SF11793.....	159
PAWS7SD24.....	223	PP116W.....	79	PSM30.....	79	RA7410.....	75	SC4GAL.....	78	SF1136.....	172	SF11794.....	159
PAWS7SD36.....	223	PP12.....	79	PSM30.....	19	RA7412.....	75	SC4RP.....	83	SF11361.....	156	SF11841.....	166
PAWS7SD60.....	223	PP12.....	19	PSM30.....	100	RA7414.....	75	SC5.....	78, 106	SF11362.....	156	SF11842.....	166
PAWS7T.....	222	PP12W.....	79	PSM3058.....	79	RA7416.....	75	SC5FT.....	78, 106	SF1137.....	172	SF11844.....	166
PAWS9.....	222	PP211.....	79	PSM3058.....	19	RA7420.....	75	SC5RP.....	83	SF1138.....	172	SF11845.....	166
PAWSBSB3518.....	225	PP2116.....	79	PSM3058.....	100	RA7422.....	75	SC6.....	78, 106	SF1141.....	97	SF11846.....	166
PAWSBSB3524.....	225	PP214.....	79	PSM30W.....	79	RA7423.....	75	SC6FT.....	78, 106	SF1142.....	97	SF11851.....	166
PAWSBSBM2.....	225	PP216.....	79	PSM30W.....	100	RA7424.....	75	SC6RP.....	83	SF11421.....	138	SF11852.....	166
PAWSBSBR24.....	225	PP34.....	79	PSM34.....	79	RA7426.....	75	SC8.....	78, 106	SF1144.....	97	SF11854.....	167
PB1016.....	72	PP58.....	79	PSM34.....	19	RA7430.....	75	SC8FT.....	78, 106	SF11442.....	138	SF11855.....	167

SF118A1.....	92	SF1363.....	120	SF16043.....	110	SF482L.....	171	SF603.....	158	SF6623.....	124	SF7993.....	172
SF118A2.....	92	SF1364.....	120	SF16046.....	110	SF483.....	150	SF603L.....	170	SF6624.....	124	SF8014.....	173
SF118A3.....	92	SF1365.....	122	SF160L1.....	118	SF483L.....	171	SF60411.....	121, 158	SF6631.....	123	SF8015.....	172
SF118A5.....	92	SF1366.....	122	SF16421.....	143	SF484.....	150	SF60412.....	121, 158	SF6632.....	123	SF8021.....	172
SF118E1.....	91	SF1367.....	122	SF16574.....	143	SF484L.....	171	SF6046.....	158	SF6633.....	124	SF8022.....	172
SF118E3.....	91	SF13710.....	122	SF16672.....	144	SF4901.....	165	SF6047.....	158	SF6634.....	124	SF802711.....	147
SF118E5.....	91	SF137415.....	91	SF16673.....	144	SF4902.....	165	SF6048.....	158	SF6635.....	125	SF802716.....	147
SF118E6.....	91	SF137416.....	91	SF16682.....	144	SF4919.....	116	SF6151.....	151	SF6636.....	125	SF80272.....	147
SF118E9.....	91	SF137417.....	91	SF16713.....	139	SF493.....	158	SF6153.....	151	SF6637.....	125	SF802722.....	154
SF118H1.....	151	SF137419.....	91	SF16721.....	165	SF4971.....	167	SF6171.....	151	SF6638.....	125	SF80276.....	147
SF118H2.....	151	SF137420.....	91	SF16722.....	165	SF4972.....	167	SF6172.....	151	SF6649.....	142	SF80278.....	147
SF118H25.....	93	SF1377.....	122	SF16802.....	145	SF4991.....	166	SF6173.....	151	SF6733.....	120	SF80279.....	147
SF1191.....	94	SF137740.....	97	SF170B4.....	24	SF5002.....	167	SF6174.....	151	SF67512.....	119	SF80A1.....	132
SF1192.....	94	SF137741.....	97	SF171.....	141	SF5002L.....	171	SF6176.....	151	SF67513.....	119	SF80A10.....	131
SF1193.....	94	SF1378.....	122	SF172.....	141	SF5021.....	167	SF6177.....	151	SF6758.....	119	SF80A11.....	132
SF1202.....	108	SF1379.....	122	SF172413.....	93	SF5031.....	167	SF621.....	148	SF6759.....	119	SF80A12.....	132
SF1203.....	108	SF13810.....	121	SF172428.....	93	SF505.....	167	SF6231.....	92	SF6791.....	142	SF80A3.....	131
SF12032.....	173	SF13811.....	121	SF173317.....	150	SF5053.....	151	SF6235.....	95	SF6811.....	137	SF80A9.....	131
SF12061.....	173	SF13812.....	121	SF173318.....	150	SF5054.....	167	SF6236.....	95	SF6812.....	137	SF81212.....	96
SF1215.....	108	SF13813.....	121	SF17833.....	154	SF505L.....	171	SF6237.....	95	SF6873.....	137	SF847.....	131
SF122A1.....	108	SF13815.....	120	SF17835.....	154	SF506.....	151	SF6239.....	95	SF6876.....	137	SF8526.....	138
SF12365.....	93	SF13816.....	121	SF17961.....	108	SF506L.....	171	SF62510.....	92	SF68910.....	125	SF8527.....	138
SF1241.....	108	SF1381N.....	107	SF18347.....	94	SF507.....	151	SF6258.....	92	SF6897.....	124	SF88C2.....	148
SF1242.....	108	SF1382.....	119	SF18348.....	94	SF507L.....	171	SF6259.....	92	SF6898.....	124	SF88Q2.....	107
SF1247.....	93	SF1383.....	121	SF18349.....	94	SF508.....	151	SF62614.....	94	SF6899.....	125	SF892.....	132
SF1251.....	108	SF1384.....	121	SF185510.....	108	SF5082.....	167	SF6263.....	94	SF6911.....	125	SF894.....	107
SF125F.....	91	SF138612.....	108	SF231.....	141	SF508L.....	171	SF6265.....	94	SF6912.....	125	SF901.....	140
SF1261.....	108	SF138613.....	108	SF232.....	141	SF5111.....	158	SF6269.....	94	SF6913.....	124	SF91041.....	143
SF12613.....	108	SF1387.....	121	SF242.....	141	SF513.....	158	SF63.....	163	SF6914.....	124	SF91046.....	143
SF1263.....	120	SF1391.....	121	SF243.....	141	SF516TB.....	92	SF6348.....	131	SF6928.....	124	SF91203.....	153
SF126C7.....	108	SF1392.....	121	SF24B1.....	141	SF521.....	139	SF6351.....	128	SF6929.....	124	SF91204.....	153
SF1272.....	107	SF14063.....	122	SF26C1.....	141	SF522.....	139	SF6352.....	128	SF6951.....	119	SF91205.....	153
SF12761.....	152	SF1407.....	121	SF34240.....	93	SF5251.....	168	SF6353.....	128	SF6952.....	119	SF91211.....	154
SF12793.....	136	SF140H1.....	120	SF34365.....	93	SF52A3.....	139	SF6354.....	128	SF6953.....	119	SF91334.....	165
SF1281.....	112	SF140H2.....	120	SF3447.....	93	SF52A4S.....	138	SF64A2.....	139	SF6954.....	119	SF91335.....	165
SF12811.....	135	SF140H3.....	120	SF345F.....	91	SF52A45L.....	170	SF64A3.....	139	SF6955.....	119	SF91472.....	173
SF12812.....	135	SF1443.....	168	SF347B.....	92	SF52E2.....	139	SF64B2.....	139	SF6961.....	142	SF91601.....	94
SF12813.....	135	SF1453.....	173	SF351.....	138	SF52F1.....	139	SF64F1.....	172	SF6963.....	142	SF91602.....	94
SF12814.....	135	SF14634.....	109	SF352.....	138	SF52H3.....	133	SF64F3.....	156	SF6973.....	120	SF91603.....	94
SF1282.....	112	SF1481.....	168	SF361.....	138	SF531.....	139	SF64F3L.....	170	SF6974.....	120	SF91604.....	94
SF12912.....	107	SF1482.....	168	SF362.....	138	SF533.....	93	SF64F5.....	156	SF7022.....	121	SF91605.....	94
SF12951.....	129	SF1491.....	168	SF371.....	138	SF533L.....	93, 171	SF64F5L.....	170	SF7023.....	121	SF91606.....	94
SF12952.....	129	SF14TB.....	92	SF373.....	138	SF5401.....	148	SF64F7.....	156	SF7074.....	109	SF916F.....	91
SF12954.....	129	SF1542.....	112	SF38365.....	93	SF5402.....	148	SF64F9.....	156	SF70D1.....	159	SF92B3.....	133
SF12955.....	129	SF1551.....	112	SF3847.....	93	SF5411.....	136	SF64G2.....	156	SF70D1L.....	170	SF92B4.....	133
SF12956.....	128	SF1552.....	112	SF38T.....	93	SF5412.....	148	SF64G3.....	133	SF70D5.....	152	SF931.....	133
SF12957.....	128	SF1553.....	112	SF38TB.....	92	SF5443.....	146	SF64G4.....	133	SF7151.....	142	SF933.....	133
SF129612.....	128	SF1554.....	112	SF4210.....	95	SF5616.....	156	SF64G5.....	133	SF7152.....	142	SF934.....	133
SF129613.....	128	SF1556.....	112	SF4224.....	95	SF5622.....	156	SF64G6.....	133	SF7181.....	144	SF943.....	133
SF1298.....	107	SF156A1.....	117	SF422US.....	95	SF5622L.....	170	SF64H10.....	155	SF7191.....	143	SF94B10.....	124
SF12T.....	93	SF156A10.....	116	SF424.....	95	SF5762.....	157	SF64H8.....	154	SF7192.....	142	SF94B11.....	125
SF12TB.....	92	SF156A3.....	117	SF429US.....	95	SF5762L.....	170	SF64I1.....	172	SF7201.....	143	SF94B12.....	125
SF13004.....	138	SF156A4.....	117	SF4412.....	152	SF5764.....	157	SF64I2.....	159	SF7202.....	143	SF94B5.....	119
SF13091.....	131	SF156A5.....	117	SF4464.....	141	SF5772.....	157	SF64I2L.....	171	SF721.....	130	SF94B6.....	119
SF13092.....	131	SF156A6.....	116	SF4471.....	141	SF5773.....	157	SF64I3.....	159	SF72711.....	108	SF94B9.....	124
SF13093.....	131	SF15716.....	117	SF4511.....	141	SF57815.....	155	SF64I3L.....	170	SF7279.....	108	SF94C1.....	137
SF13094.....	131	SF1581.....	92	SF4513.....	152	SF57818.....	155, 170	SF64I4.....	150	SF731.....	130	SF94C11.....	137
SF13095.....	131	SF15815.....	92	SF4521.....	152	SF581.....	136	SF64I5.....	150	SF732.....	130	SF94C12.....	137
SF13151.....	132	SF15816.....	92	SF466.....	153	SF58240.....	93	SF64I3.....	159	SF733.....	130	SF94C2.....	137
SF132310.....	116	SF1583.....	92	SF469.....	146	SF58365.....	93	SF64L3L.....	170	SF742.....	132	SF94C3.....	133
SF13255.....	116, 161	SF1586.....	92	SF4691.....	139	SF5847.....	93	SF64L4.....	159	SF748.....	132	SF94C4.....	133
SF13291.....	123	SF158B1.....	118	SF4710.....	152	SF585F.....	91	SF64L4L.....	170	SF7511.....	107	SF94C5.....	133
SF13296.....	123	SF158B6.....	118	SF4711.....	152	SF5895.....	152	SF6513.....	126	SF7515.....	107	SF94C6.....	133
SF132C12.....	107	SF158B7.....	118	SF4712.....	154	SF5973.....	159	SF6514.....	126	SF7533.....	130	SF94E1.....	137
SF134G1.....	146	SF158B8.....	118	SF4752.....	164	SF5973L.....	159	SF6533.....	163	SF7555.....	159	SF94E2.....	137
SF134G2.....	146	SF1591.....	118	SF479.....	154	SF5991.....	90	SF6534.....	163	SF7555L.....	170	SF94E3.....	137
SF134G3.....	146, 159	SF1593.....	118	SF4791.....	132	SF5992.....	95	SF658.....	93	SF7556.....	159	SF94E4.....	137
SF134G4.....	146	SF1594.....	118	SF4792.....	164	SF5993.....	95	SF658L.....	93, 171	SF7556L.....	170	SF94E5.....	137
SF1361.....	120	SF1595.....	118	SF4801.....	163	SF5994.....	95	SF6611.....	125	SF78TB.....	92	SF94E6.....	137
SF13610.....	120	SF1596.....	118	SF481.....	150	SF5995.....	95	SF6612.....	125	SF7972.....	172	SF94P1.....	130
SF13611.....	120	SF1597.....	118	SF481L.....	171	SF5997.....	95	SF6613.....	123	SF7977.....	172	SF94Q1.....	130
SF1362.....	120	SF15F.....	91	SF482.....	150	SF601.....	151	SF6614.....	123	SF7991.....	173	SF94Q5.....	130

SF981.....169	SFG2061.....175	SP161617.....236	WM4266016.....3	WS152.....232	WSC120.....219	WSSSR.....231
SFB4.....118	SFG2062.....175	SP161618.....236	WM4266020.....3	WS152241.....216, 235	WSCAP.....221	WSTG.....219
SFB6.....118	SFG2091.....175	SP161620.....236	WM4267220.....3	WS152245.....216, 235	WSCB30.....210	WST5.....232
SFC14.....134	SFG2121.....180	SP1654.....237	WMA2WC1.....5	WS164.....232	WSCR39L.....213	WSU200.....220
SFC4.....134	SFG2162.....175	SP180.....237	WMB1WC1.....5	WS176.....232	WSCR39S.....213	WSUA.....220
SFC6.....134	SFG2202.....177	SP203.....237	WMM2W112.....5	WS178S.....232	WSCRG.....221	WSWH10.....210
SFE022S.....80	SFG2222.....174	SP205.....237	WMS800.....5	WS18R.....228	WSCS.....221	WSWH20.....210
SFEB061.....182	SFG2231.....174	SP23H.....234	WR18AL.....212	WS1G.....219	WSCSB.....221	WSWH30.....210
SFEB071.....182	SFG2262.....180	SP9816.....237	WR30818.....212	WS2001.....210	WSCT10FA.....209	WSWYPO.....210
SFED05316.....183	SFG2263.....180	SP9831.....237	WR308332.....212	WS200M.....213	WSEG300.....209	WT11.....77
SFED06.....182	SFG2264.....180	SP9839.....236	WR601118.....212	WS2100X.....210	WSEG500.....209	WT100.....76
SFED06SX.....182	SFG231.....145	SP9848.....236	WR6011332.....212	WS2119B.....218	WSEGM50G.....209-210	WT112.....77
SFED07.....182	SFG2361.....176	SP9889.....236	WR6011532.....212	WS21NT.....218	WSF3003N.....213	WT115.....77
SFED07SX.....182	SFG2391.....176	SPWSSG.....237	WR6013116.....212	WS225M.....213	WSFCLN.....213	WT115G.....77
SFEF1X1904.....182	SFG2412.....177	SR10.....117	WR601318.....212	WS2275.....218	WSFGRN.....213	WT12.....77
SFEF1X1905.....182	SFG2421.....177	SR312.....117	WR6013332.....212	WS238S.....232	WSFRSDL.....221	WT12G.....77
SFEF7X704.....182	SFG2432.....177	SR4.....117	WR701418.....212	WS241458.....215	WSFRSDM.....221	WT13.....77
SFEF7X705.....182	SFG251.....145	SR412.....117	WR7014332.....212	WS247148.....220	WSFRSDXL.....221	WT132.....76
SFEMM04.....182	SFG2551.....178	SR5.....117	WR701818.....212	WS247149.....220	WSFRSDXXL.....221	WT135.....76, 82
SFEMM05.....182	SFG2552.....178	SR512.....117	WR7018332.....212	WS25.....210	WSFRSGL.....221	WT137.....76, 82
SFEMMF06DX.....182	SFGD0012.....179	SR514.....117	WR7018532.....212	WS250532.....215	WSFRSGM.....221	WT14.....77
SFEMMF06SX.....182	SFGD0043.....144	SR6.....117	WRBR18.....211	WS251292.....215	WSFRSGXL.....221	WT2.....77
SFESF051.....182	SFGD0045.....144	SR8.....117	WRBR332.....211	WS2519B.....218	WSFRSGXXL.....221	WT217.....76
SFESF083.....182	SFGD0046.....144	SRST312.....117	WRBRF18.....211	WS258098.....220	WSFRSKL.....221	WT231.....76
SFEST041DX.....182	SFGD0047.....144	SRST4.....117	WRBRF332.....211	WS258099.....220	WSFRSKM.....221	WT232.....76
SFEST041SX.....182	SFGD0048.....149	SRST412.....117	WRCAST.....212	WS258100.....220	WSFRSKXL.....221	WT3.....77
SFET06.....182	SFGD0049.....149	SRST5.....117	WRSP5601118.....212	WS25NT.....218	WSFRSKXXL.....221	WT300.....76
SFETF04DX.....183	SFGD0050.....149	SRST512.....117	WRSP56011332.....212	WS260938.....215	WSFS.....230	WT4.....77
SFETF04SX.....183	SFGD0051.....149	SRST514.....117	WRSP56011532.....212	WS2619B.....218	WSHB29.....233	WT412.....76
SFETF05DX.....183	SFGD1512.....144	SS12G.....88	WRSP5601318.....212	WS263038.....214	WSHS26.....233	WT5.....77
SFETF05SX.....183	SFGD1581.....155	STBF1136.....88	WRSP56013332.....212	WS271346.....215	WSHS3TB.....233	WT6.....77
SFETM04DX.....183	SFGD1582.....155	STBF1140.....88	WRSP5701418.....212	WS271349.....215	WSHSB.....225	WT6B.....77
SFETM04SX.....183	SFGD2282.....155	STBF1142.....88	WRSP5701818.....212	WS278S.....232	WSHT3.....209	WT6BG.....77
SFETM05DX.....183	SFGD2451.....181	STBF1236.....88	WRSP57018332.....212	WS282005.....215	WSL22.....209	WT7.....77
SFETM05SX.....183	SFGD2452.....181	STBF1236LP.....88	WRSP57018532.....212	WS287369.....215	WSL24.....232	WT7G.....77
SFETSM10.....183	SFGD2711.....135	STBF1240.....88	WRSP601018.....212	WS2C200.....209	WSL33.....209	WT8.....77
SFETT05.....183	SFGD3023.....178	STBF1240LP.....88	WRSP6010332.....212	WS2G.....218	WSL48.....232	WT8041.....76, 82
SFETW05DX.....182	SFGD3033.....178	STBF1242.....88	WRSP6010532.....212	WS300.....209	WSLC10.....209	WT8047.....76, 82
SFETW05SX.....182	SFGD761.....181	STBF1242LP.....88	WRSP601118.....212	WS3004CWL.....219	WSLC10M.....209	WT8049.....76, 82
SFF057.....127	SFGD762.....181	STBF1248.....88	WRSP6011332.....212	WS3004CWM.....219	WSLJ.....221	WT9.....77
SFF058.....126	SFGD991.....143	STCR36.....88	WRSP6011532.....212	WS3004CWL.....219	WSLPG200.....209	WTC178R.....76
SFF059.....127	SFN0010.....149	STCR39.....88	WRSP601318.....212	WS301551.....219	WSM3R.....228	WTC2P.....76
SFF060.....126	SFN0016.....149	STCR42.....88	WRSP6013332.....212	WS312S.....232	WSML00895.....216	WTC2P12.....76
SFF077.....127	SFN4641.....162	STF1.....88	WRSP701418.....212	WS316.....209	WSMP.....232	WTC2P38R.....76
SFF078.....127	SFN4642.....162	STF2.....88	WRSP7014332.....212	WS3TL.....219	WSMPL.....232	WTC2P78R.....76
SFF079.....127	SFN4643.....162	STF4.....88	WRSP701818.....212	WS412S.....232	WSMTL.....232	WTC3.....76
SFF080.....126	SFN4644.....162	STF6.....88	WRSP7018332.....212	WS4501.....210	WSNG.....211	WTC3P12R.....76
SFF081.....126	SFS12.....134	STSP36.....89	WRSP7018532.....212	WS4J.....219	WSP750L.....218	WTC32.....76
SFF082.....126	SFS14.....134	STSP36F.....89	WRT18.....212	WS5002X.....210	WSP750LX.....218	WTC4.....76
SFF083.....127	SFS16.....134	STSP40.....89	WRT332.....212	WS50H.....210	WSPMOR.....231	WTC412R.....76
SFF084.....127	SP100.....237	STSP40F.....89	WS0215L.....218	WS5DG.....219	WSPMR.....231	WTC42.....76
SFF085.....127	SP101.....237	STSP42.....89	WS0215X.....218	WS674.....210	WSPMW.....231	WTC6.....76
SFF086.....127	SP110.....237	STSP42F.....89	WS100.....210	WS675.....210	WSPMY.....231	WTC64.....76
SFG0010.....142	SP1112.....236	STTA.....88	WS100M.....213	WS6LN.....228	WSRL.....232	WTC658R.....76
SFG0011.....142	SP1115.....236	T40.....73	WS10102.....221	WS6R.....228	WSS20.....210	WW023.....211
SFG0015.....164	SP1124.....236	TX14112.....73	WS10103.....221	WS7061.....211	WSS2510.....217	WW030.....211
SFG0019.....179	SP113.....237	TX142.....73	WS10104.....221	WS770257.....214	WSS2540.....217	WW03010.....211
SFG005.....163	SP1134.....236	TX143.....73	WS10420D.....217	WS7CR.....228	WSS2565.....217	WW03010SS.....211
SFG007.....179	SP114.....236	TXFA3716BZ.....72	WS10465D.....217	WS8R.....228	WSS30.....210	WW0301A.....211
SFG008.....164	SP115.....236	TXFATPNTG37.....72	WS10C250.....209	WS912L.....219	WSS7210.....217	WW0302FC.....211
SFG009.....164	SP1156.....236	TXFATRITool.....72	WS10C300.....209	WS912X.....219	WSS7260.....217	WW0302SS.....211
SFG1591.....161	SP117.....237	VCSH7436.....210	WS10CR.....228	WS9672L.....219	WSSA00818.....216	WW030FC.....211
SFG1592.....161	SP118.....236	VCSH7536.....210	WS10L.....213	WS9672XL.....219	WSSB631.....217	WW035.....211
SFG1631.....161	SP120.....237	WB58114.....225	WS10L45.....213	WS97205.....216	WSSB631A.....217	WW03510.....211
SFG1632.....161	SP121.....237	WB58116.....225	WS11L.....213	WS97305.....216	WSSB851.....217	WW0352FC.....211
SFG1641.....174	SP12GS.....237	WB58234C.....225	WS11L45.....213	WS97455.....210	WSSB852.....217	WW035FC.....211
SFG1642.....174	SP130.....237	WB58234K.....225	WS11R.....228	WS9R.....228	WSSB861.....217	WW045.....211
SFG1761.....145	SP140.....237	WB58234K6.....225	WS12L.....213	WSAS.....211	WSSB862.....217	X118B.....19
SFG1763.....145	SP1402.....237	WM218848120.....4	WS12L45.....213	WSB120.....209	WSSH.....231	X119B.....19
SFG1891.....180	SP151.....237	WM225048120.....4	WS12LC.....228	WSB62.....209	WSSHR.....231	X120B.....19
SFG1892.....180	SP160.....237	WM319248120.....4	WS1501.....216, 235	WSBF1.....211	WSSSC.....231	X121B.....19
SFG1923.....145	SP1614.....234, 237	WM4264820.....3	WS150M.....213	WSBSL1866.....210	WSSSF.....231	X64934B.....19
						X9X34B.....19

Our Extensive Selection of Steel Includes

- Angle
- Channel
- Square Tube
- Rectangular Tube
- Pipe
- Plate
- Sheet
- Flat Bar
- Expanded Metal
- Beams
- Decking
- Carbon Steel
- Stainless Steel
- Aluminum
- Galvanized Steel
- Painted Steel

"Load & Go"! Material can be cut for easy transportation

Bring us your material list for a fast & easy quote

We offer short pieces of steel at discounted prices

No Minimum Order

WE DELIVER!

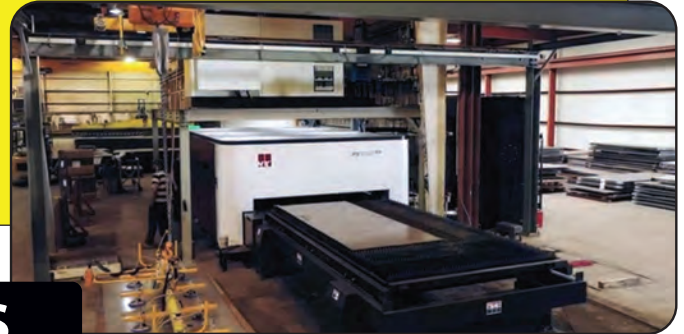

PROCESSING CAPABILITIES

Quick Turnaround | Competitive Pricing

Custom Steel Products in Five Easy Steps



Beam Cambering



Sawing



Miter Sawing



Forming

1. Tell Us What You Need
2. Approve Our Quote
3. Quality Control
4. Production Begins
5. Order is Complete



Drilling



Angle Processing



Hole Punching



Rebar Processing



Laser Processing

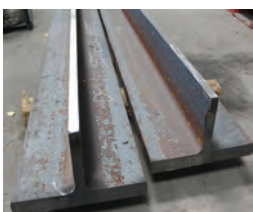

T-Splitting

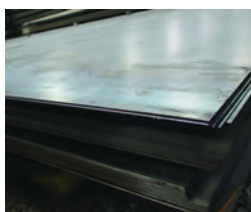

Shearing

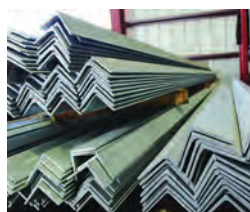

Galvanizing



Plate Processing



Plate Drilling

Two Convenient Locations to Serve You

Tucker

2018 Steel Drive
Tucker, GA 30084

Toll Free Number: (888) 416-6999

Phone Number: (770) 416-6999

Fax Number: (770) 416-9041

Gainesville

455 Industrial Boulevard
Gainesville, GA 30501

Toll Free Number: (888) 297-6675

Phone Number: (770) 297-6675

Fax Number: (770) 297-6676

WE'RE EXPANDING!

SteelMart Athens

200 Dairy Park Road
Athens, GA 30607

Please Call Our Tucker Location for
More Information

Visit Us Online at
www.steelmartatlanta.com

